



US00D351476S

United States Patent [19]

[11] Patent Number: **Des. 351,476**

Grosfillex

[45] Date of Patent: **** Oct. 11, 1994**

[54] **STEP LADDER**

[75] Inventor: **Raymond Grosfillex, Oyonnax, France**

[73] Assignee: **Grosfillex Sarl, Oyonnax, France**

[**] Term: **14 Years**

[21] Appl. No.: **1,607**

[22] Filed: **Nov. 17, 1992**

[30] **Foreign Application Priority Data**

May 22, 1992 [XH] Hague DMA/001797

[52] U.S. Cl. **D25/63; D6/350**

[58] Field of Search **D6/349, 350; 182/33, 182/33.4, 180, 20-26, 93, 132, 159; D25/64-65**

[56] **References Cited**

U.S. PATENT DOCUMENTS

- D. 198,679 7/1964 Cartner D15/8
- D. 212,086 8/1968 Gilman D15/8
- D. 273,919 5/1984 Pasinski D6/32
- D. 297,790 9/1988 Melvin D6/350

- D. 307,800 5/1990 Hradisky D25/65
- D. 330,462 10/1992 Szablak et al. D6/350
- D. 335,966 6/1993 Schwartz et al. D6/350
- 1,933,602 11/1933 Scherer 182/33
- 2,666,210 1/1954 Wiley 182/33
- 4,753,320 6/1988 Walter 182/33

Primary Examiner—A. Hugo Word
Assistant Examiner—Doris Clark
Attorney, Agent, or Firm—Dowell & Dowell

[57] **CLAIM**

The ornamental design for a step ladder, as shown and described.

DESCRIPTION

FIG. 1 is a front perspective view of a step ladder showing my new design;
FIG. 2 is a front elevational view thereof;
FIG. 3 is a rear elevational view thereof;
FIG. 4 is a elevational view taken from the right side thereof, a view taken from the left side being a mirror image thereof;
FIG. 5 is a top view thereof; and,
FIG. 6 is a bottom view thereof.

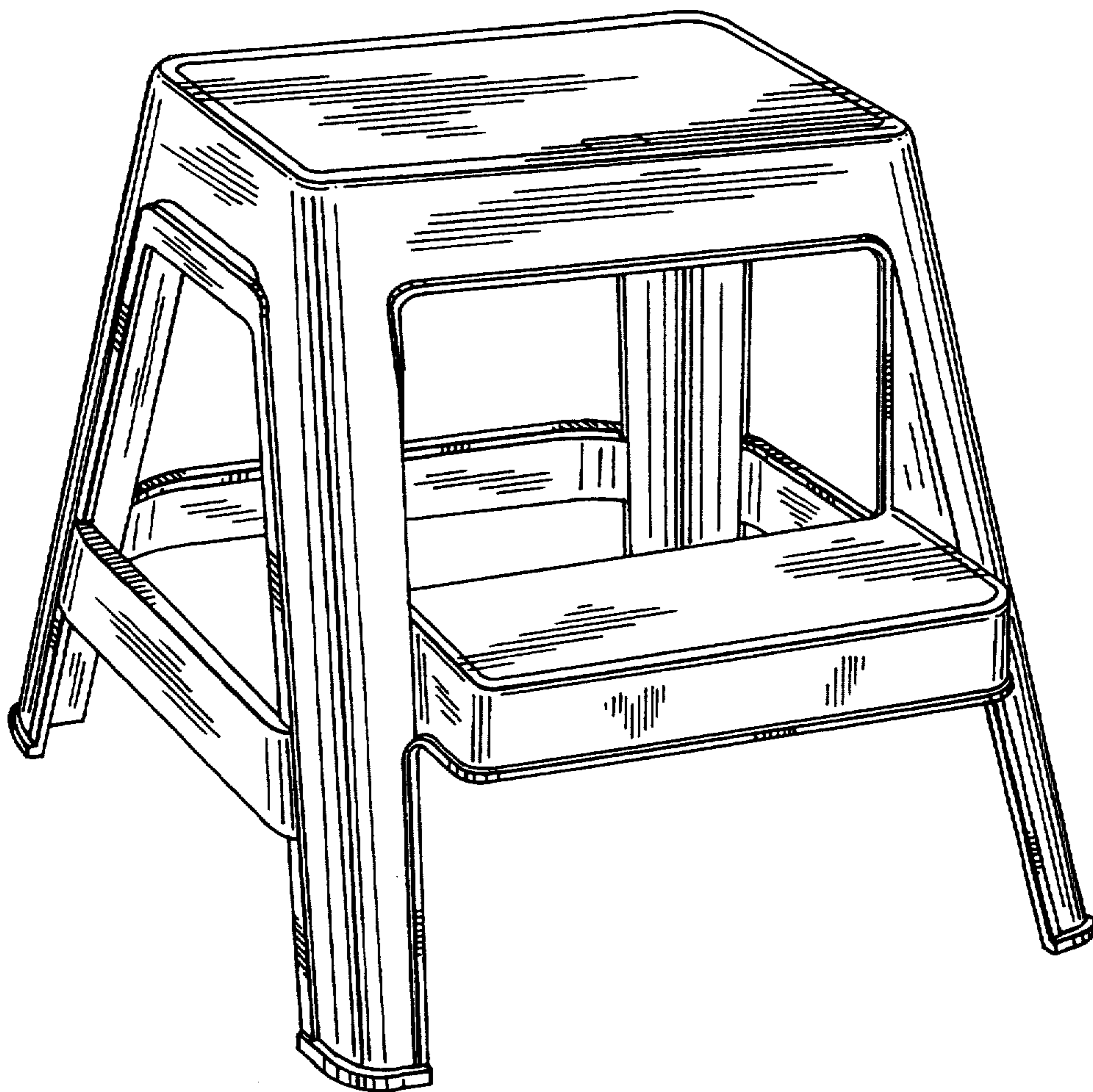

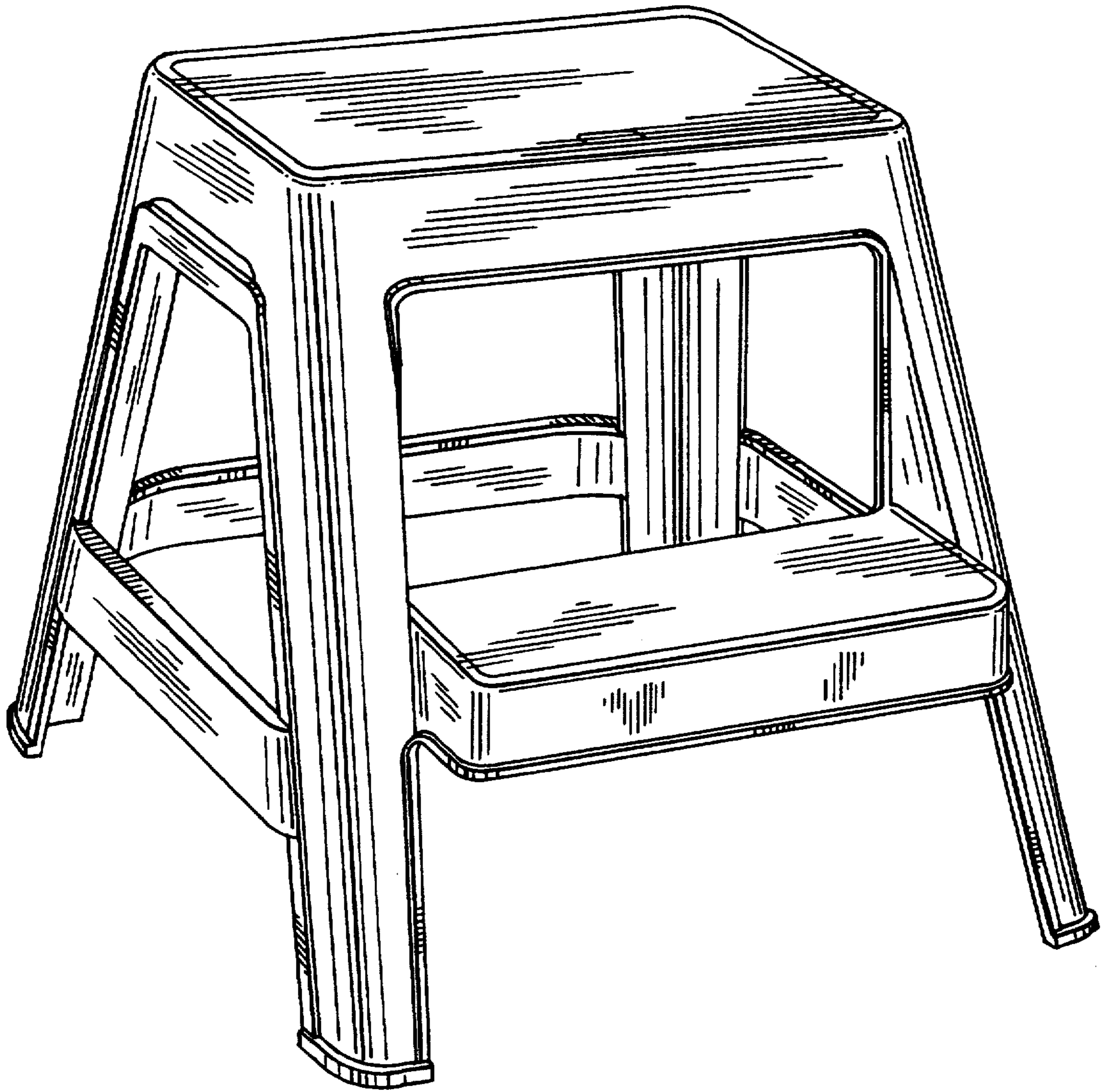

FIG. 1

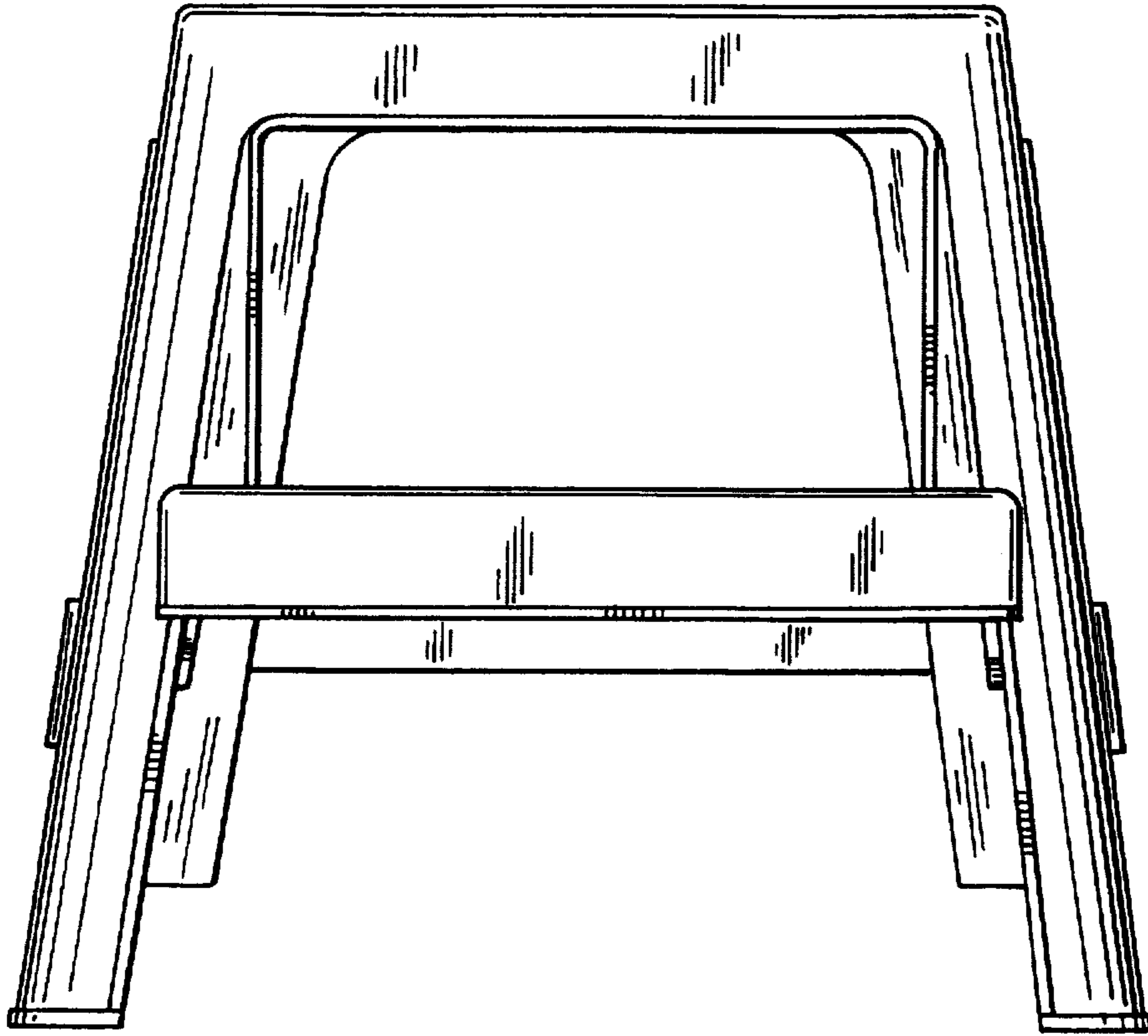

FIG. 2

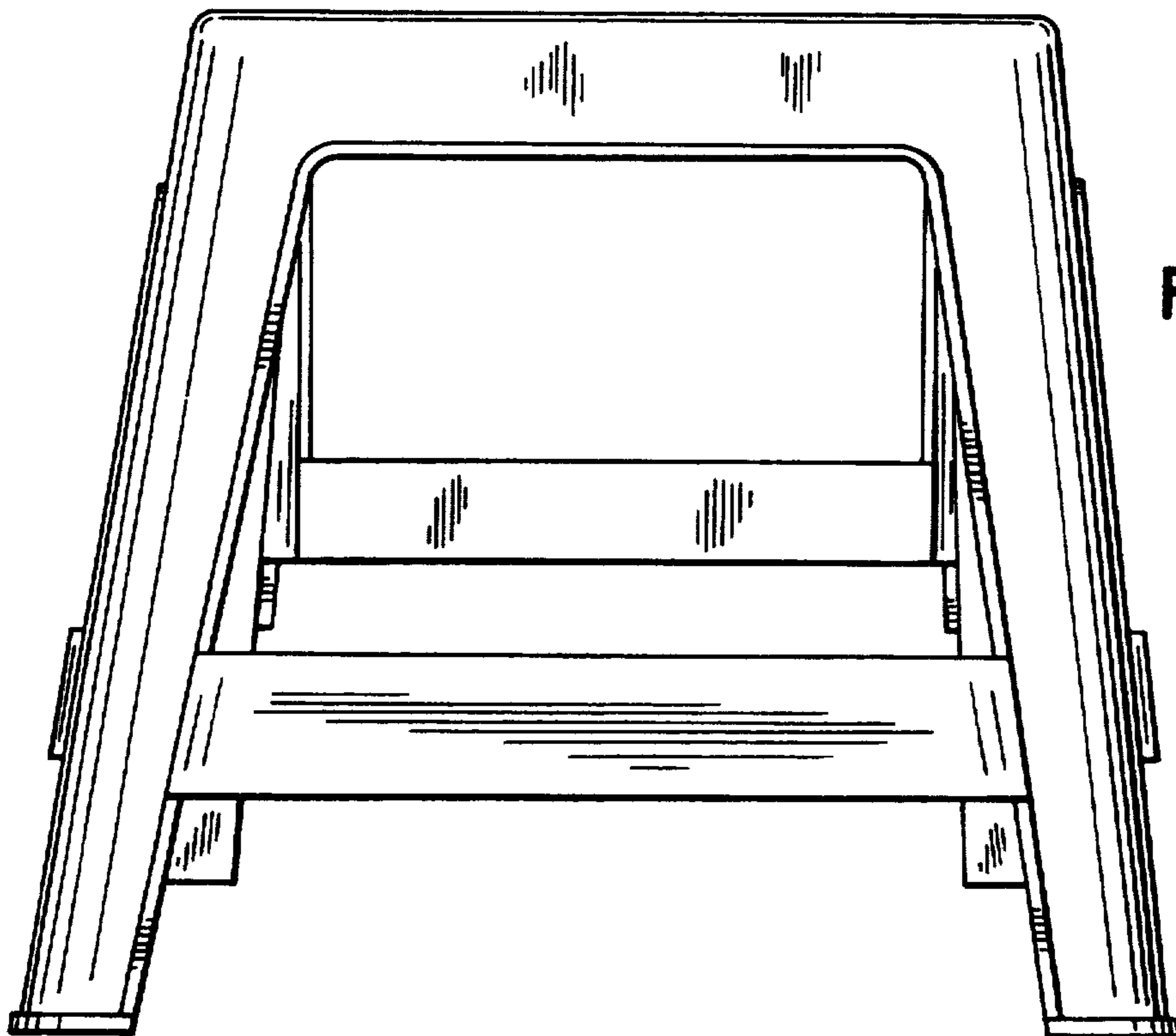

FIG. 3

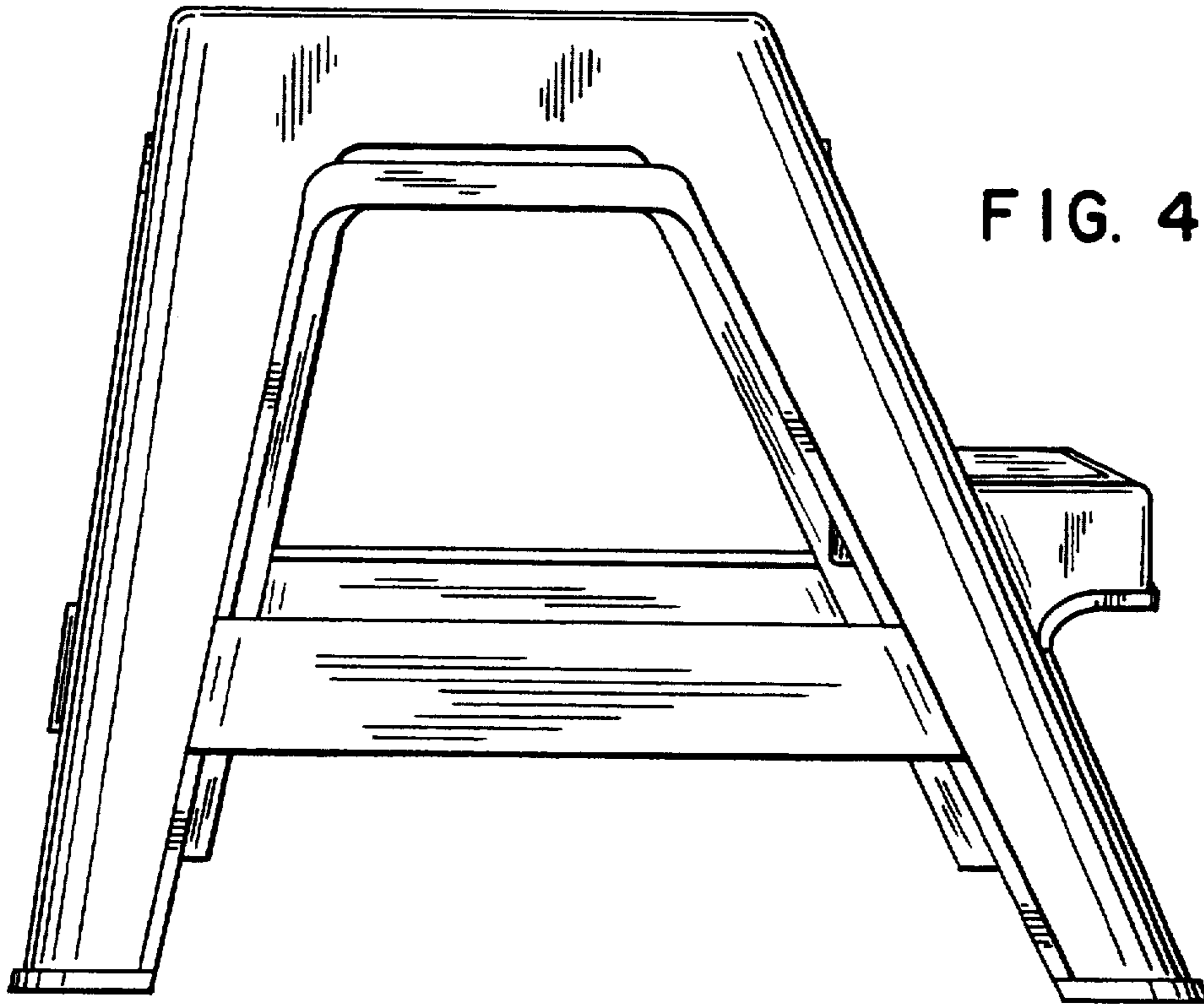

FIG. 4

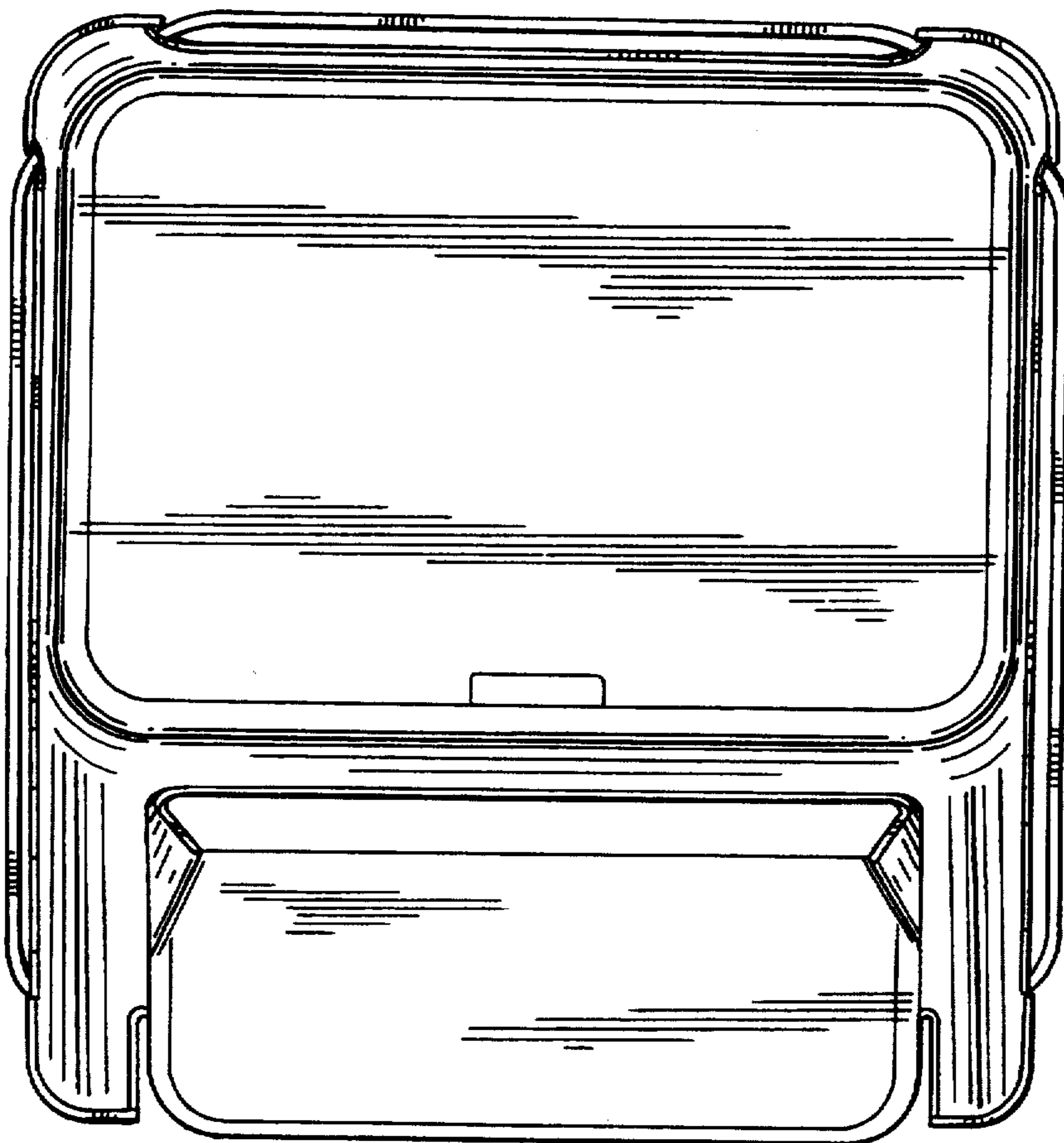

FIG. 5

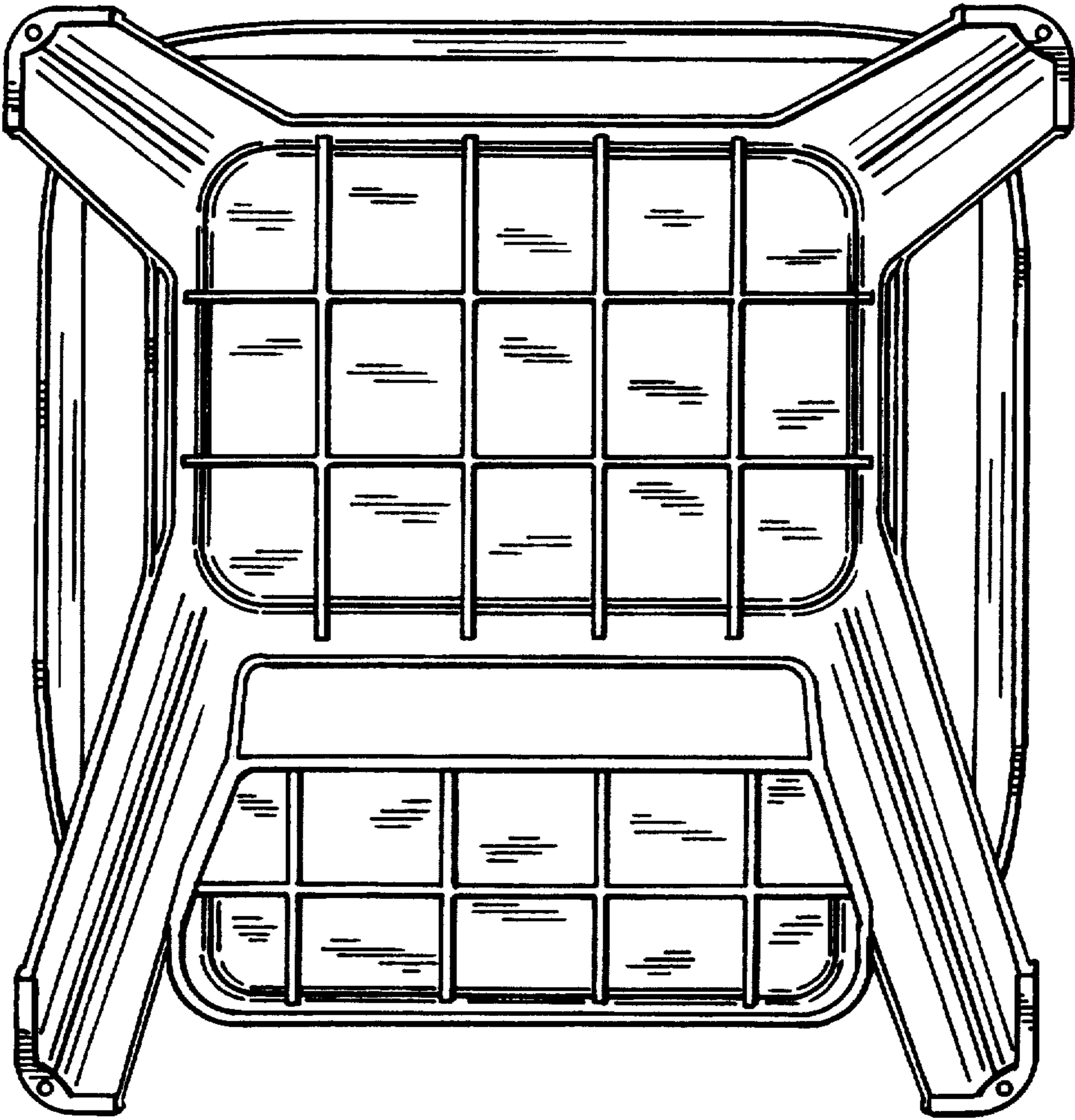

FIG. 6