



US00D351451S

United States Patent [19]
Storz

[11] **Patent Number: Des. 351,451**
[45] **Date of Patent: ** Oct. 11, 1994**

[54] **FISHING REEL FRAME**

[75] **Inventor: Achim Storz, Zell Am See, Austria**

[73] **Assignee: ABU Garcia Produktion AB, Svangsta, Sweden**

[**] **Term: 14 Years**

[21] **Appl. No.: 3,924**

[22] **Filed: Jan. 21, 1993**

[52] **U.S. Cl. D22/140**

[58] **Field of Search 242/257-260, 242/279, 261, 262, 234-240; D22/140**

[56] **References Cited**

U.S. PATENT DOCUMENTS

D. 336,325 6/1993 Asano D22/140

OTHER PUBLICATIONS

Cabela's 1992 Spring, p. 22, Garcia Max Series Reels, (top left corner).

Primary Examiner—A. Hugo Word
Assistant Examiner—Doris V. Coles
Attorney, Agent, or Firm—Browdy and Neimark

[57] **CLAIM**

The ornamental design for a fishing reel frame, as shown and described.

DESCRIPTION

FIG. 1 is a perspective view showing the underside, the left side and the front of a fishing reel frame according to the invention;

FIG. 2 is a perspective view showing the top side, the right side and the rear side of the fishing reel frame;

FIG. 3 shows the fishing reel frame from behind;

FIG. 4 shows the fishing reel frame from the front;

FIG. 5 shows the fishing reel frame from above;

FIG. 6 shows the fishing reel frame from the right;

FIG. 7 shows the fishing reel frame from the left; and,

FIG. 8 shows the fishing reel frame from below.

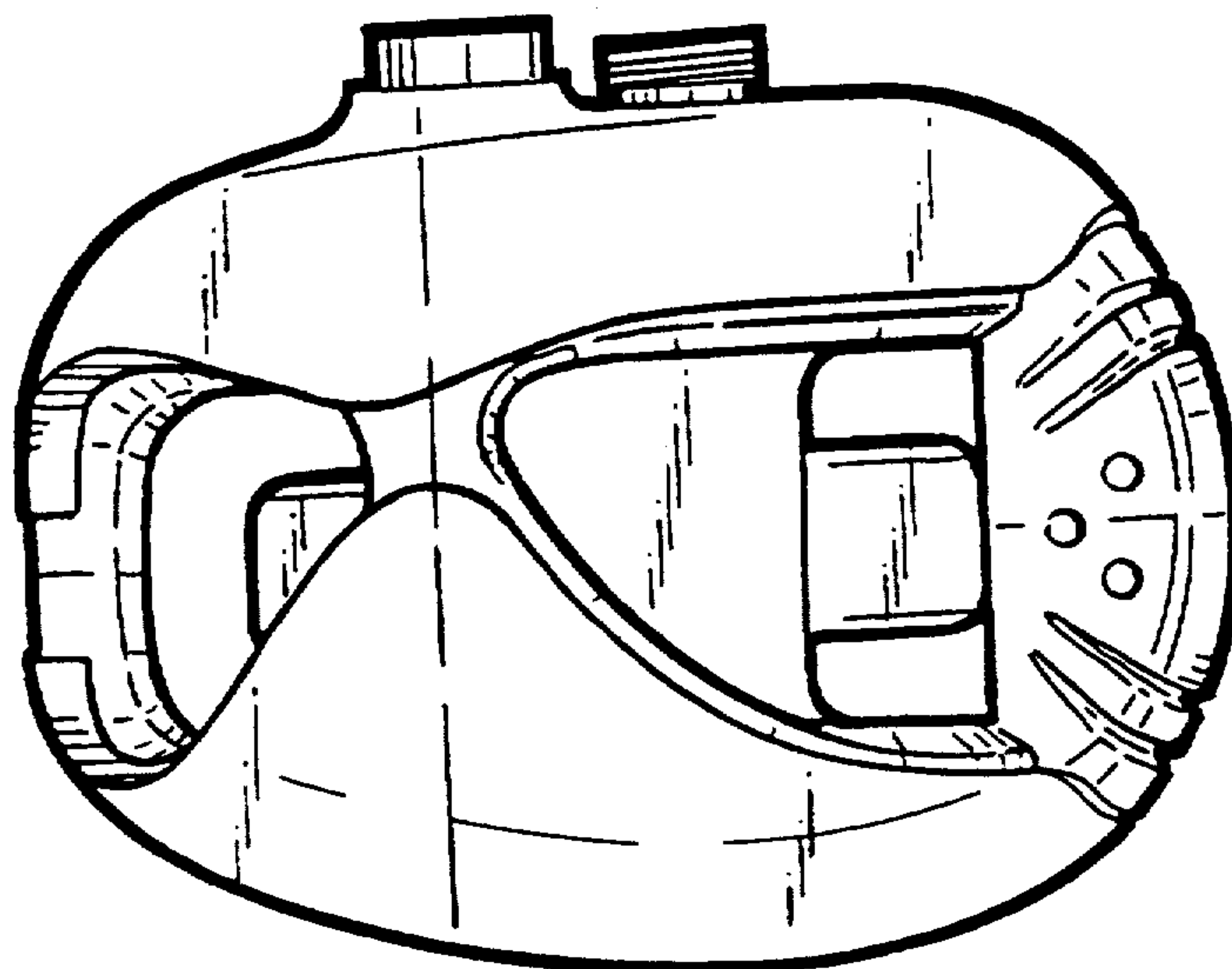

FIG.1

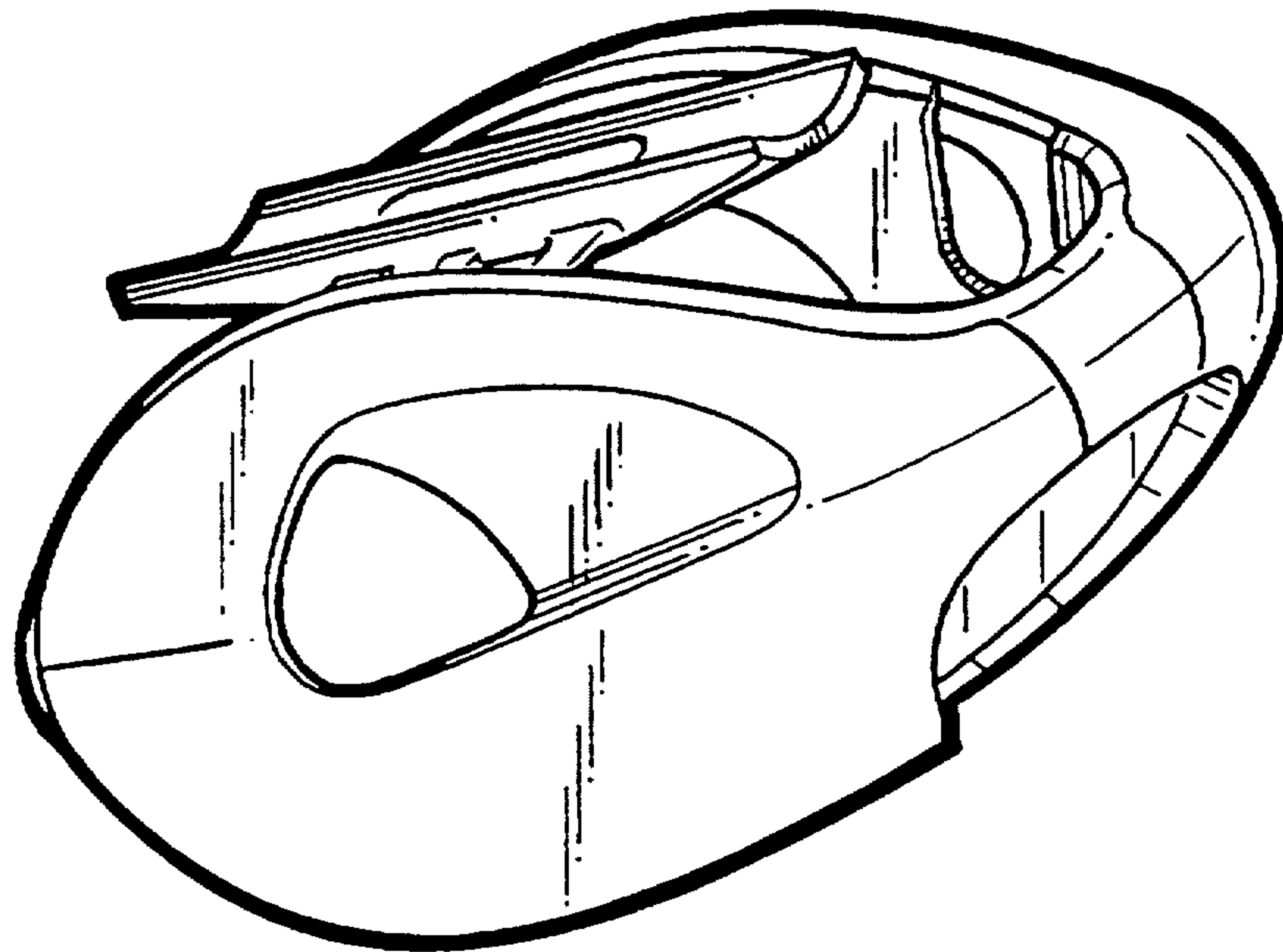

FIG.2

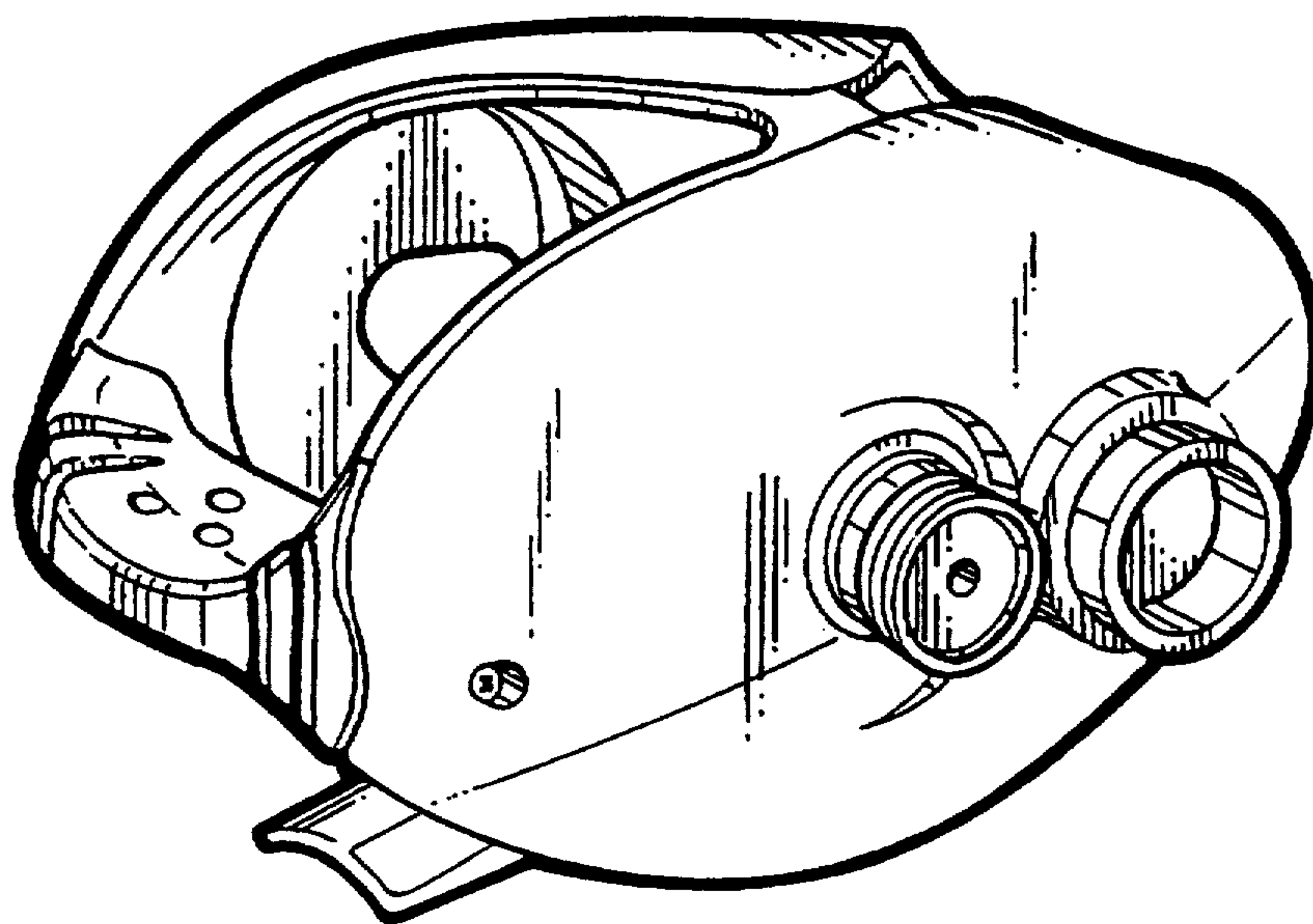

FIG.3

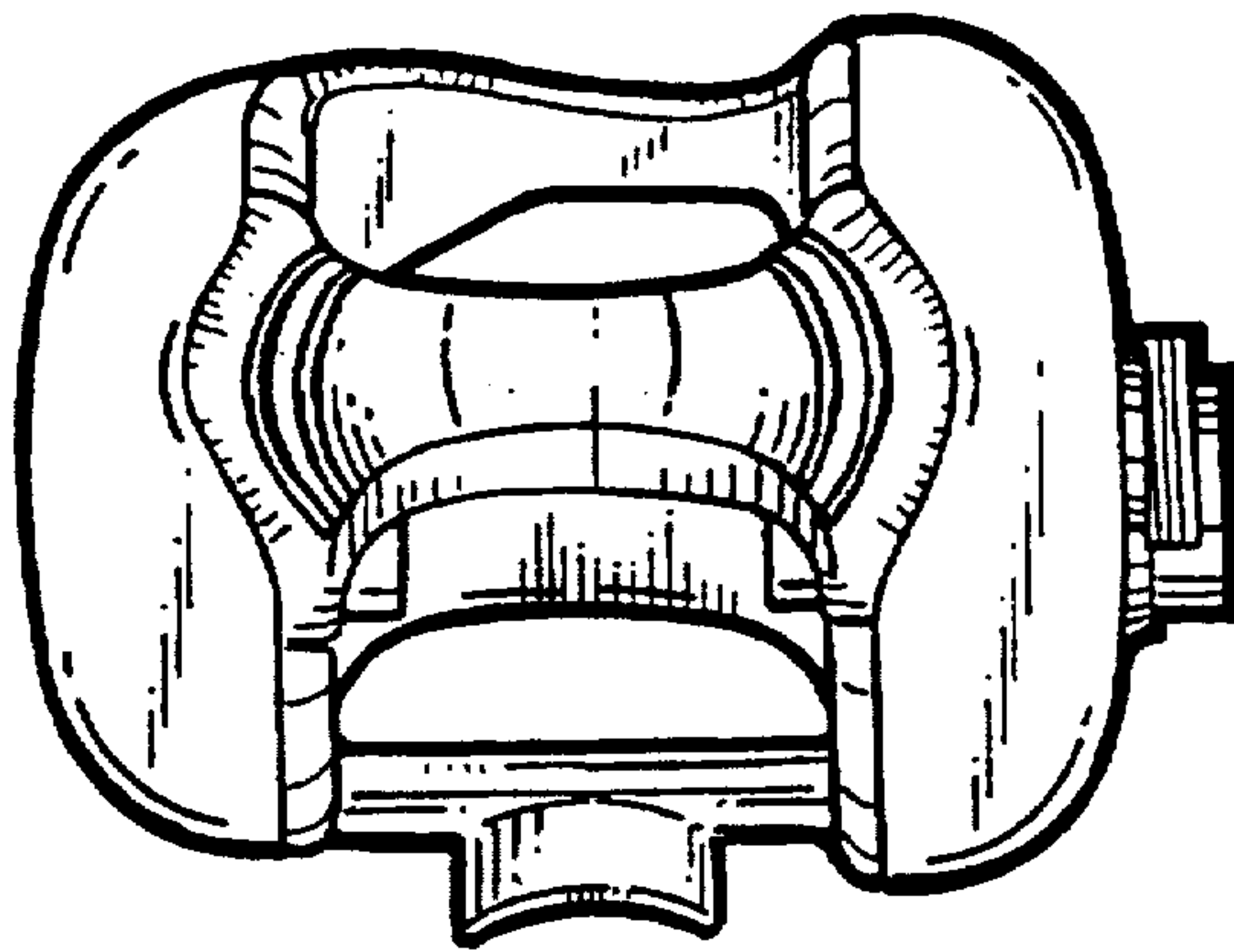

FIG.4

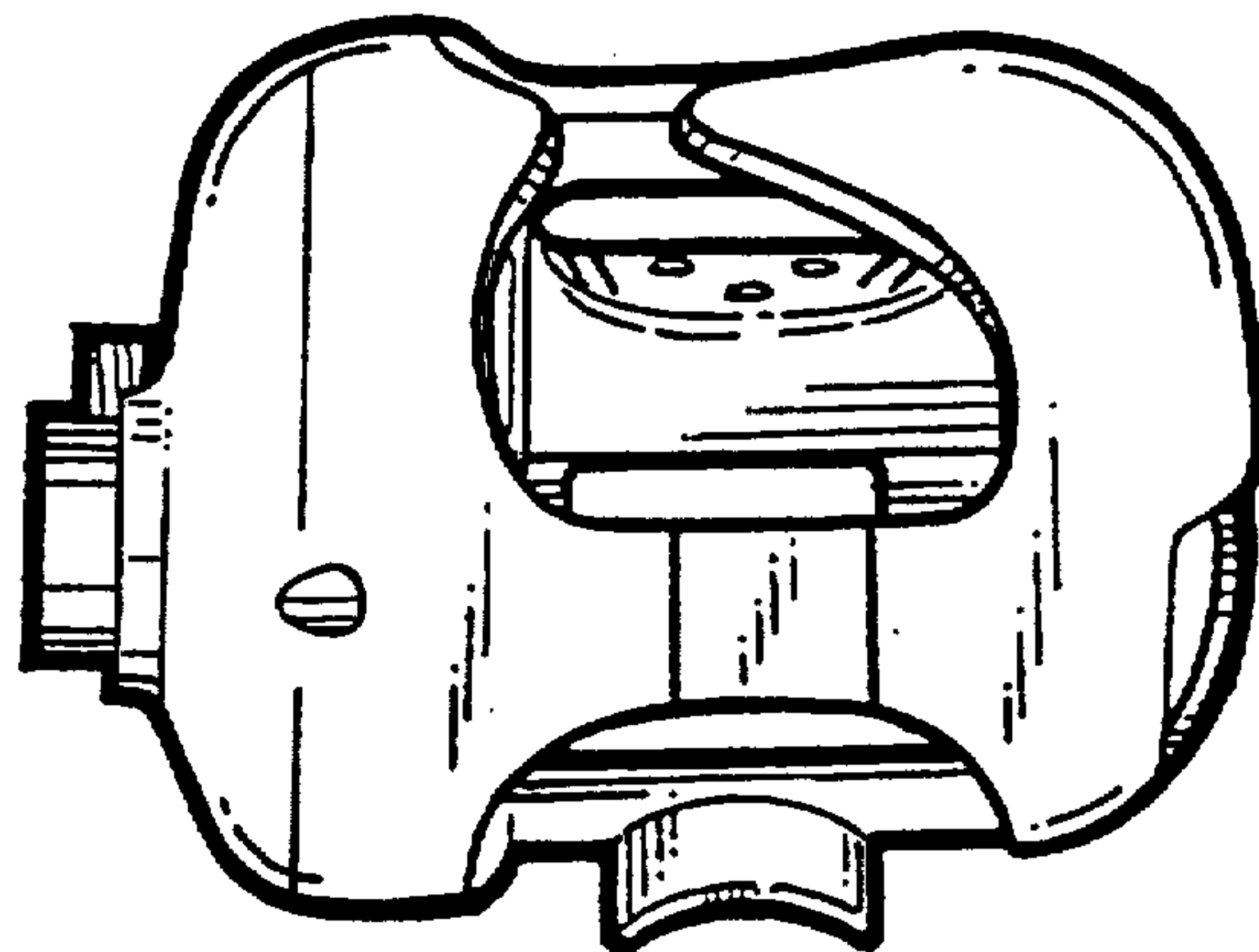

FIG.5

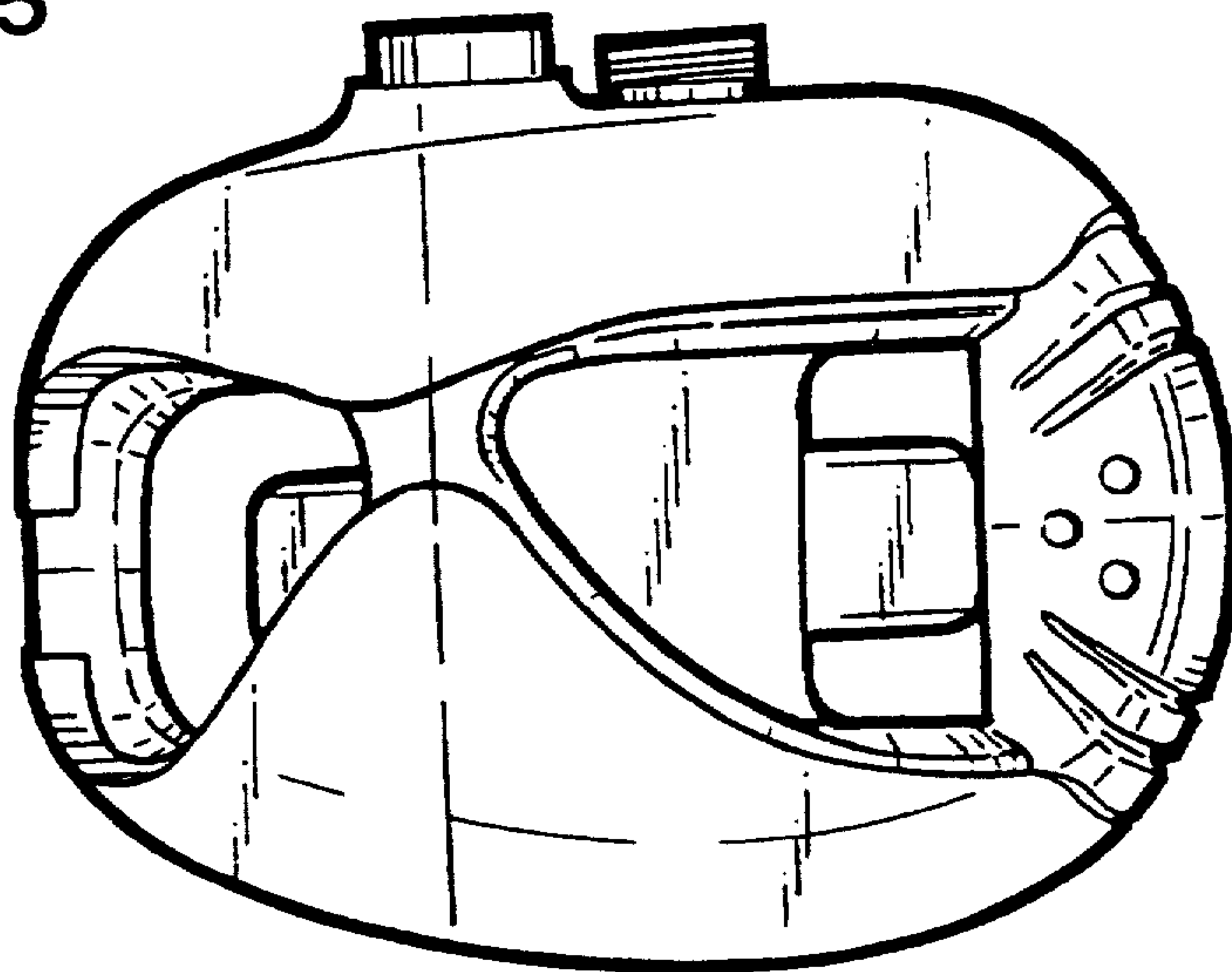

FIG.6

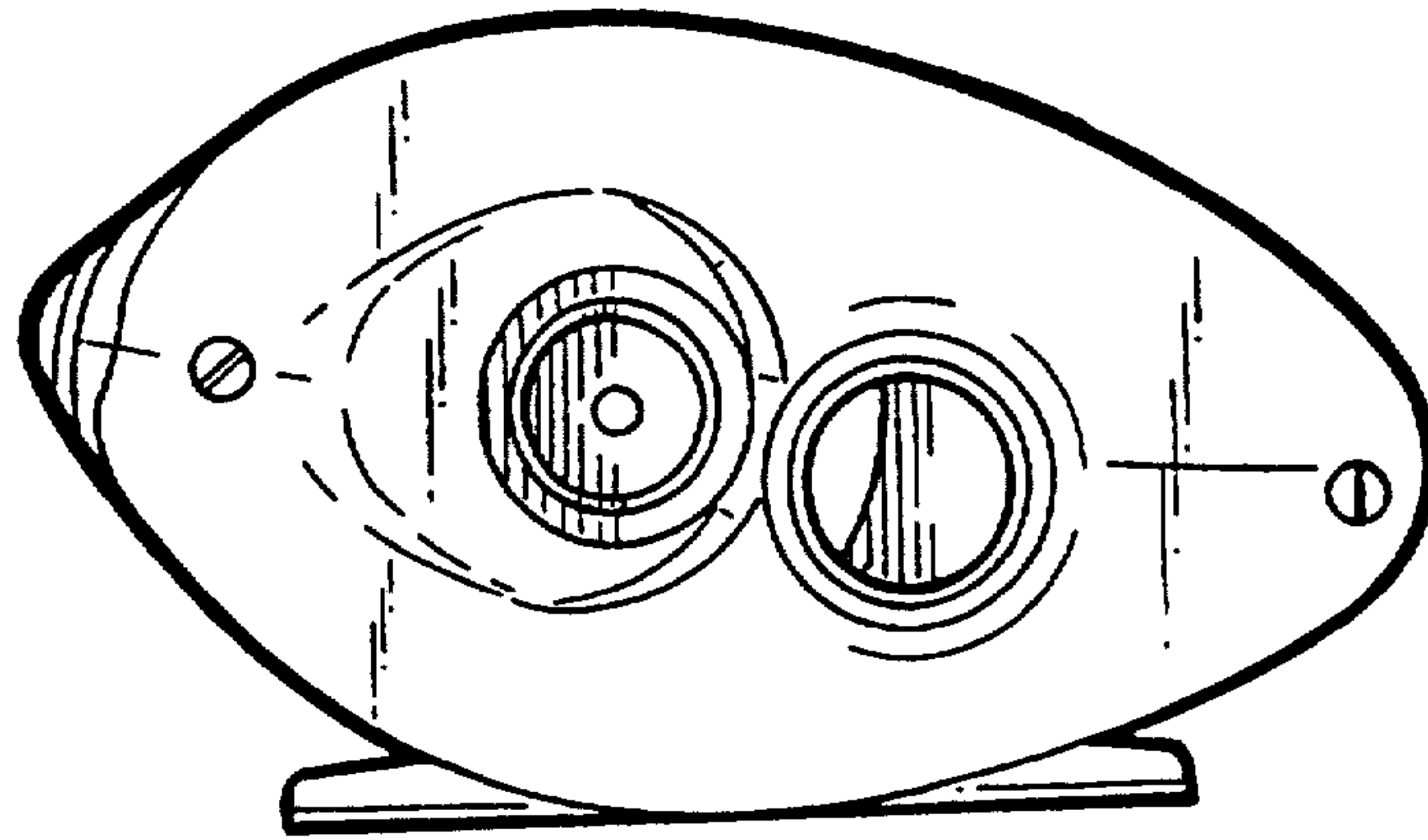

FIG.7

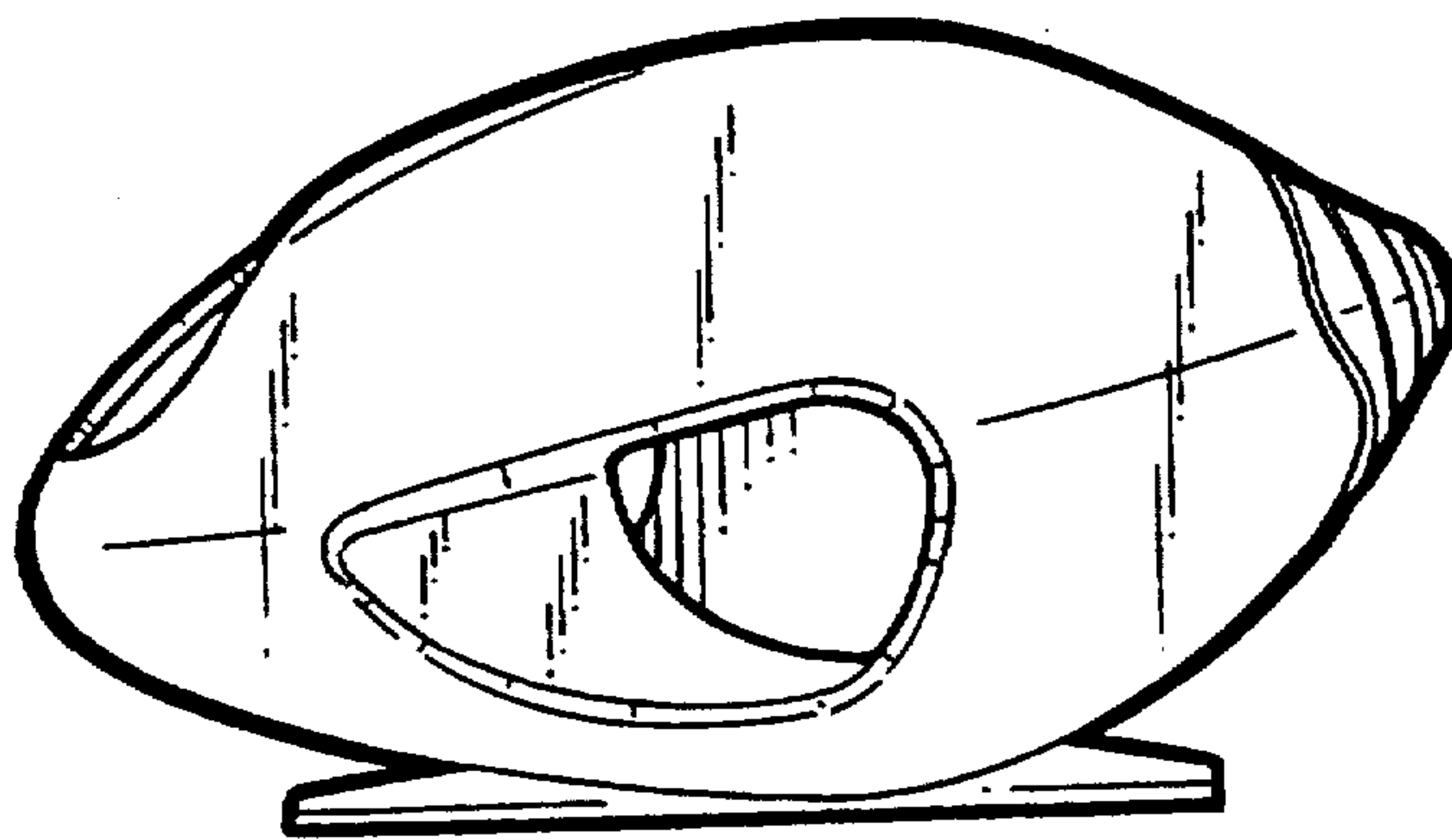

FIG.8

