



US00D351407S

United States Patent [19]

[11] Patent Number: **Des. 351,407**

Ewert

[45] Date of Patent: **** Oct. 11, 1994**

[54] **CALCULATOR WITH ADVERTISING SPACES FOR SHOPPING CART HANDLE**

Assistant Examiner—Robert M. Spear
Attorney, Agent, or Firm—Arnold, White & Durkee

[75] Inventor: **John P. Ewert, Tulsa, Okla.**

[57] **CLAIM**

[73] Assignee: **ADDvantage Media Group, Inc., Tulsa, Okla.**

The ornamental design for a calculator with advertising spaces for shopping cart handle, as shown and described.

[**] Term: **14 Years**

DESCRIPTION

[21] Appl. No.: **841,088**

FIG. 1 is a front view of a calculator with advertising spaces for shopping cart handle, showing my new design;

[22] Filed: **Mar. 2, 1992**

FIG. 2 is a left side view;

[52] U.S. Cl. **D18/7**

FIG. 3 is a right side view;

[58] Field of Search **235/10, 1 R; D18/1,**

FIG. 4 is a bottom view;

D18/2, 6, 7, 11; D34/21, 27

FIG. 5 is a top view;

FIG. 6 is a rear view;

[56] **References Cited**

U.S. PATENT DOCUMENTS

FIG. 7 is a left side view of a second embodiment of my new design, the front view thereof being identical to that of FIG. 1;

D. 227,770	7/1973	Yamamoto .	
D. 287,730	12/1986	Stoll .	
D. 321,577	11/1991	Ellis et al. .	
D. 328,607	8/1992	Brennan	D18/7
3,251,543	5/1966	Bush	235/1 R
3,314,601	4/1967	Voo .	
4,334,278	6/1982	Marmon .	
4,446,528	5/1984	Marmon .	
4,450,994	5/1984	Holland .	
4,454,414	6/1984	Benton .	
4,458,320	7/1984	Sutton .	
4,496,058	1/1985	Harris .	
4,512,504	4/1985	Owlett .	
4,685,701	8/1987	Amundson .	
4,802,575	2/1989	Martin .	
4,858,353	8/1989	Krebs .	
4,892,192	1/1990	Hague .	
4,901,901	2/1990	Reitenour .	
4,954,003	9/1990	Shea .	
5,048,736	9/1991	Anatra .	
5,176,392	1/1993	Graebe, Jr.	D34/27

FIG. 8 is a right side view of the second embodiment;

FIG. 9 is a bottom view of the second embodiment;

FIG. 10 is a top view of the second embodiment;

FIG. 11 is a rear view of the second embodiment;

FIG. 12 is a front view of a third embodiment of my new design;

FIG. 13 is a left side view of the third embodiment;

FIG. 14 is a right side view of the third alternate embodiment;

FIG. 15 is a bottom view of the third alternate embodiment;

FIG. 16 is a top view of the third alternate embodiment;

FIG. 17 is a rear view of the third alternate embodiment;

FIG. 18 is a left side view of a fourth embodiment of my new design, the front view thereof being identical to that of FIG. 12;

FIG. 19 is a right side view of the fourth embodiment;

FIG. 20 is a bottom view of the fourth alternate embodiment;

FIG. 21 is a top view of the fourth alternate embodiment;

FIG. 22 is a rear view of the fourth alternate embodiment; and,

FIG. 23 is a perspective view of the embodiment of FIG. 1.

FOREIGN PATENT DOCUMENTS

G8701440.8 3/1987 Fed. Rep. of Germany .

OTHER PUBLICATIONS

The "ShopCal" brochure.
Visual Merchandising & Store Design, May 1989, p. 63.

Primary Examiner—Alan P. Douglas

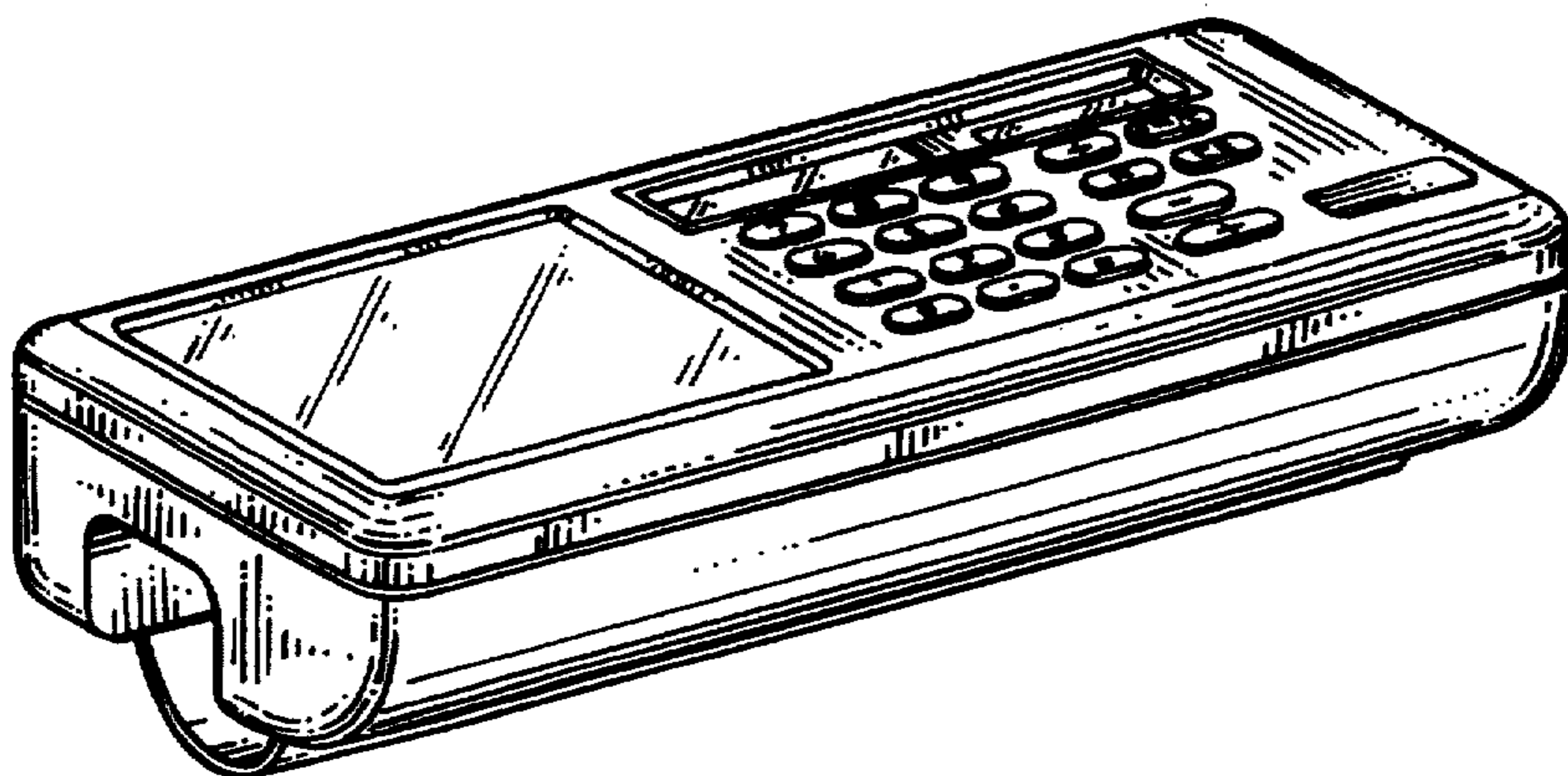

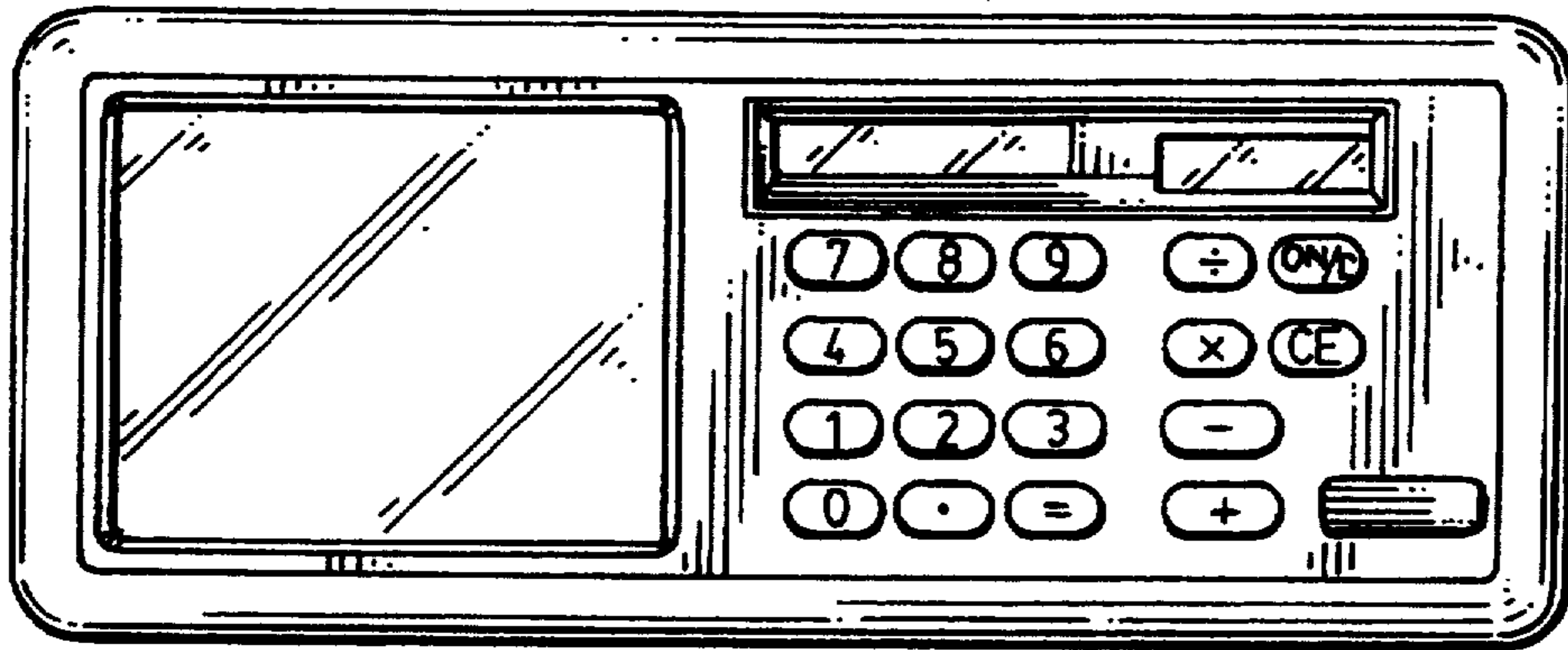

Fig. 1

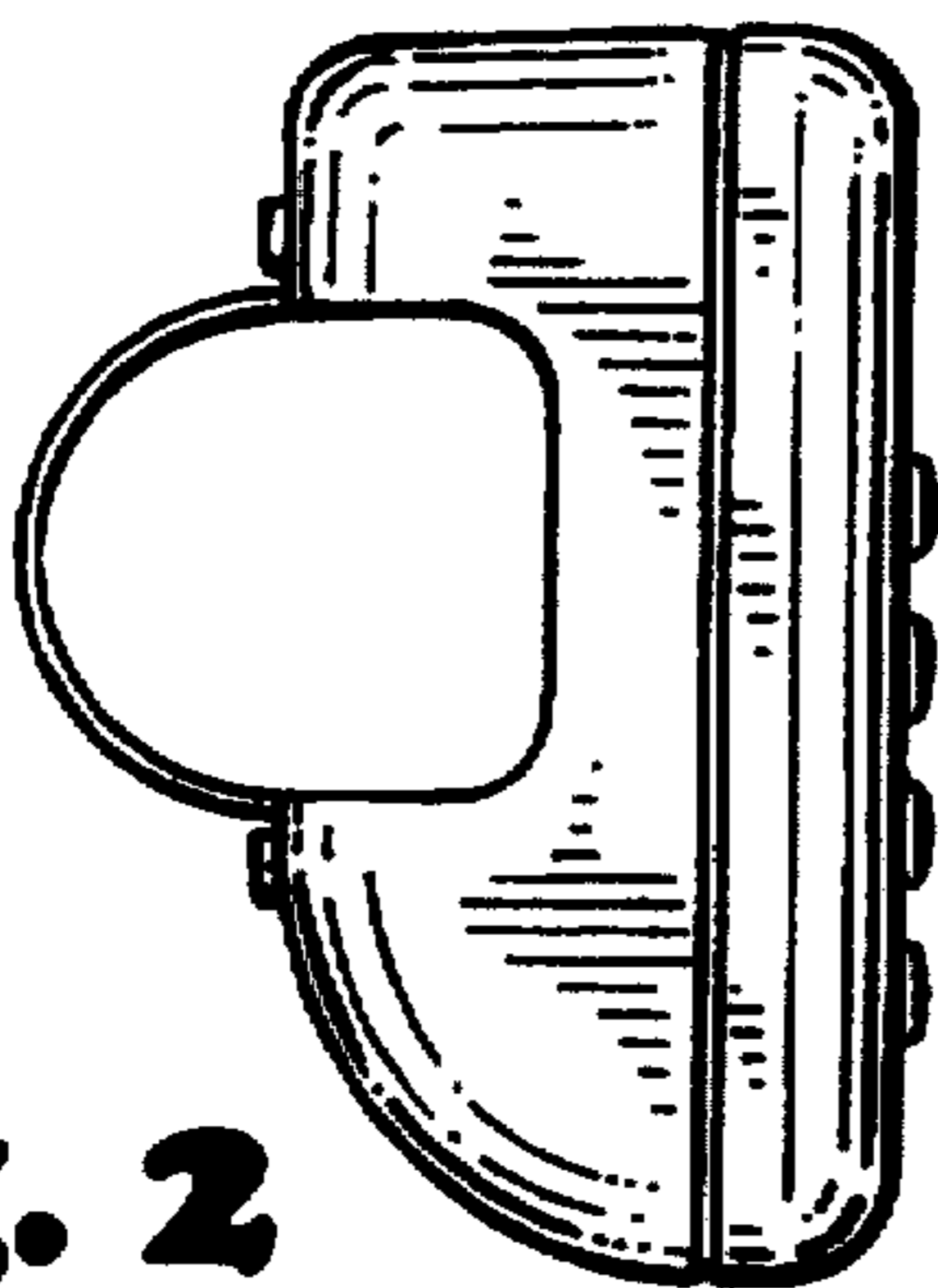

Fig. 2

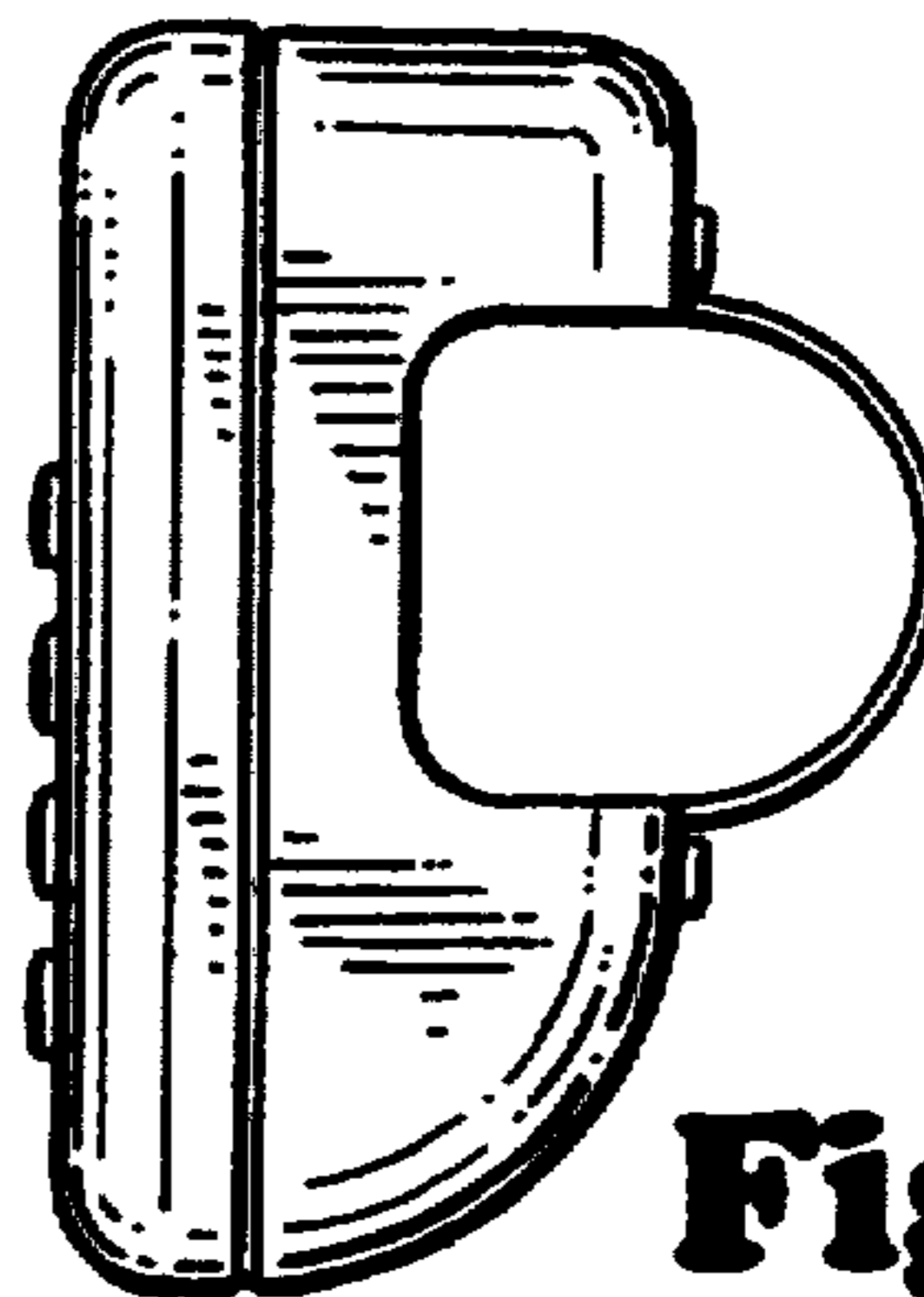

Fig. 3

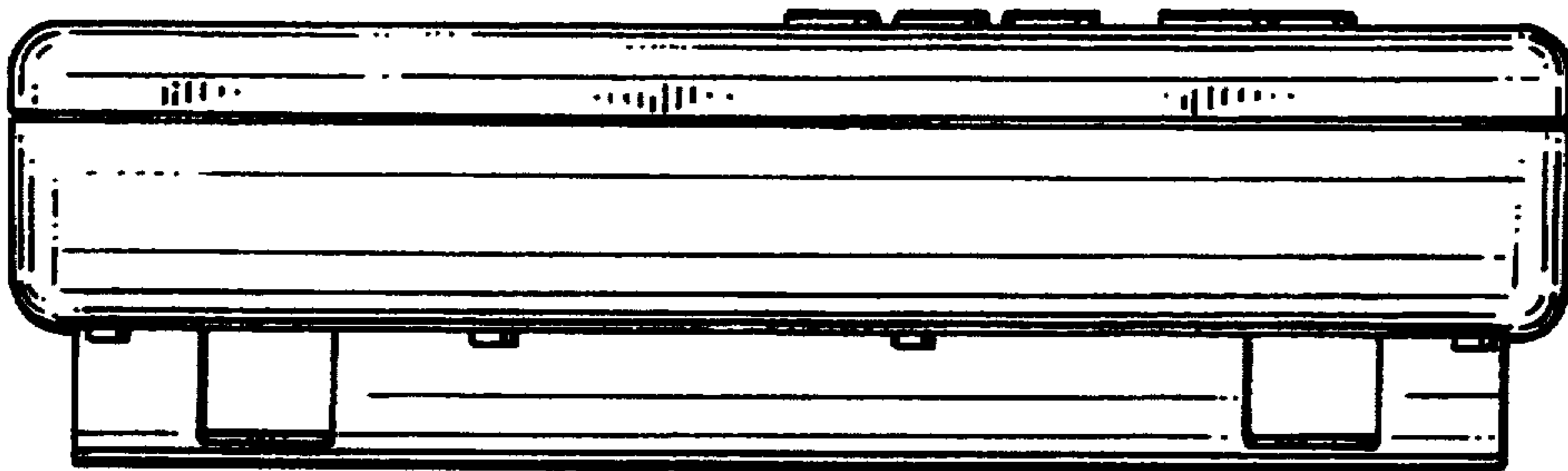

Fig. 4

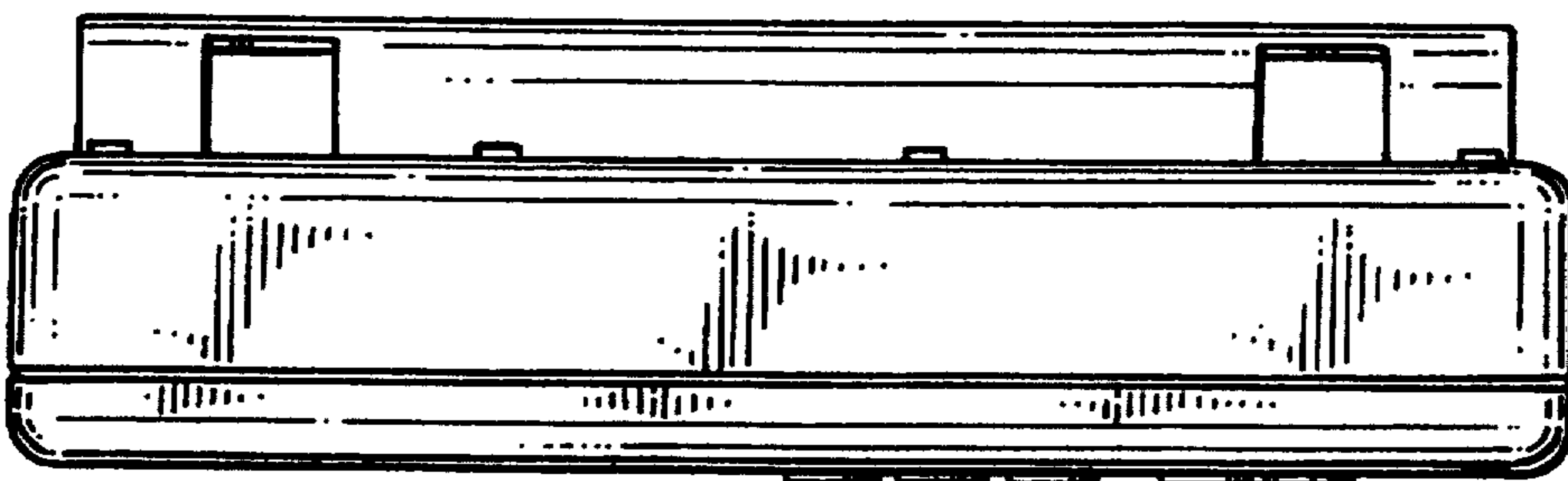

Fig. 5

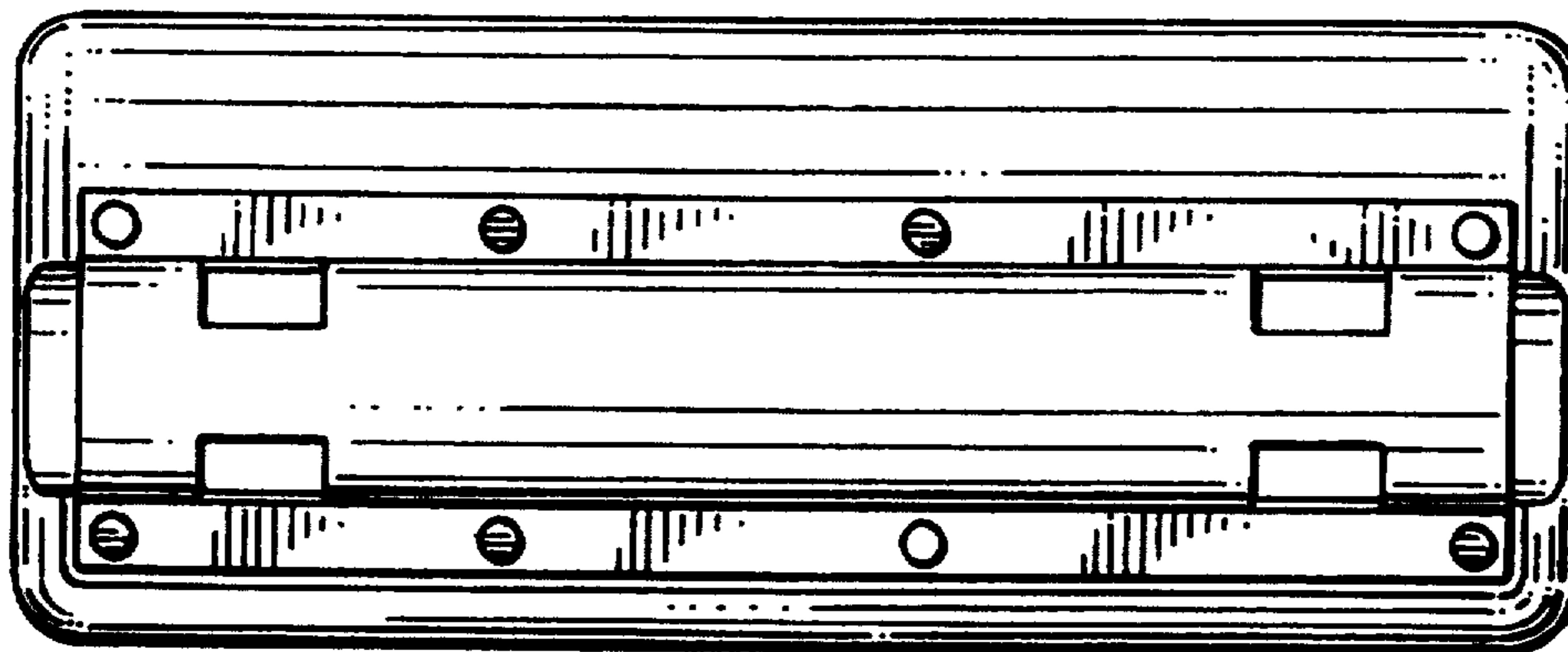

Fig. 6

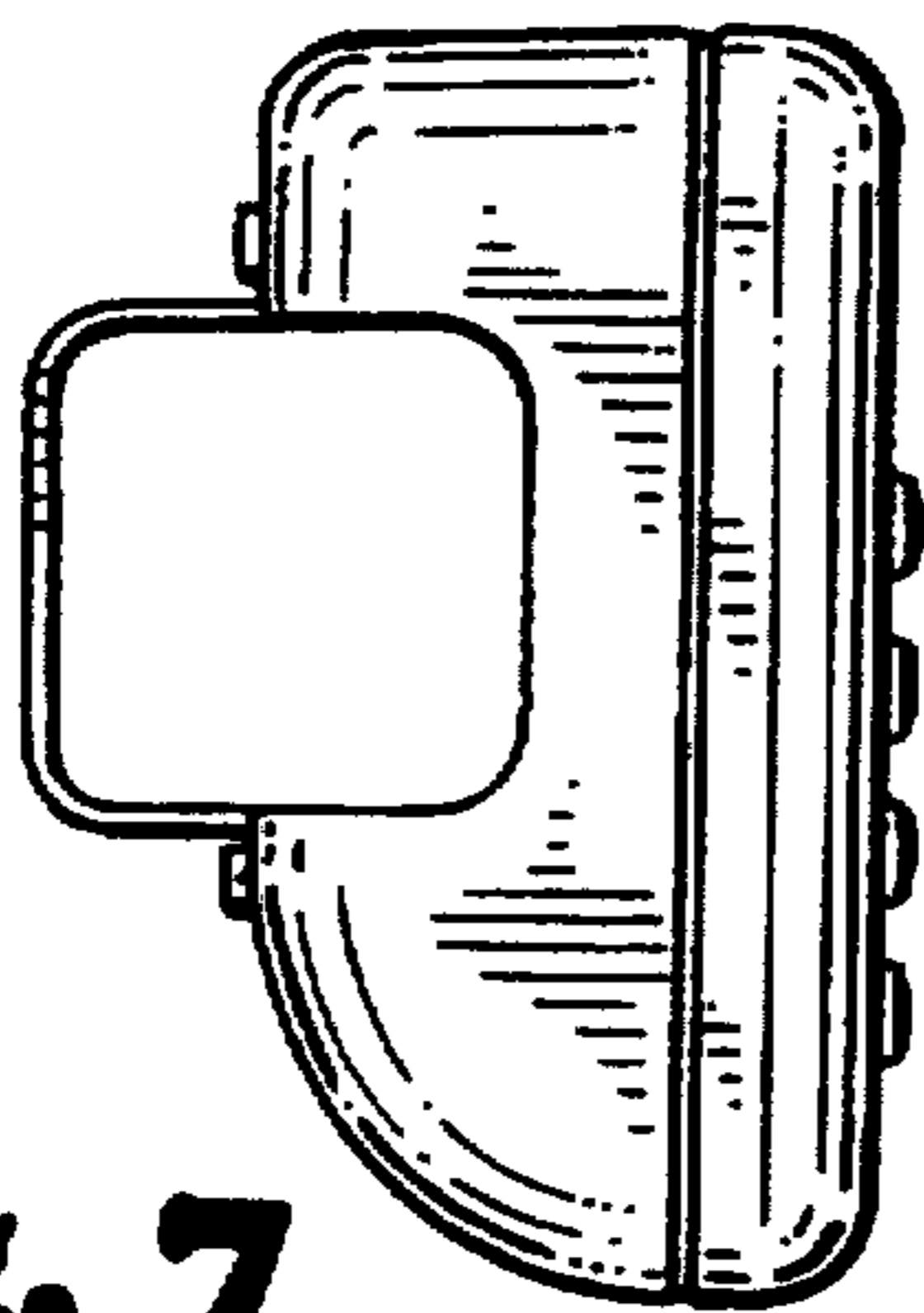

Fig. 7

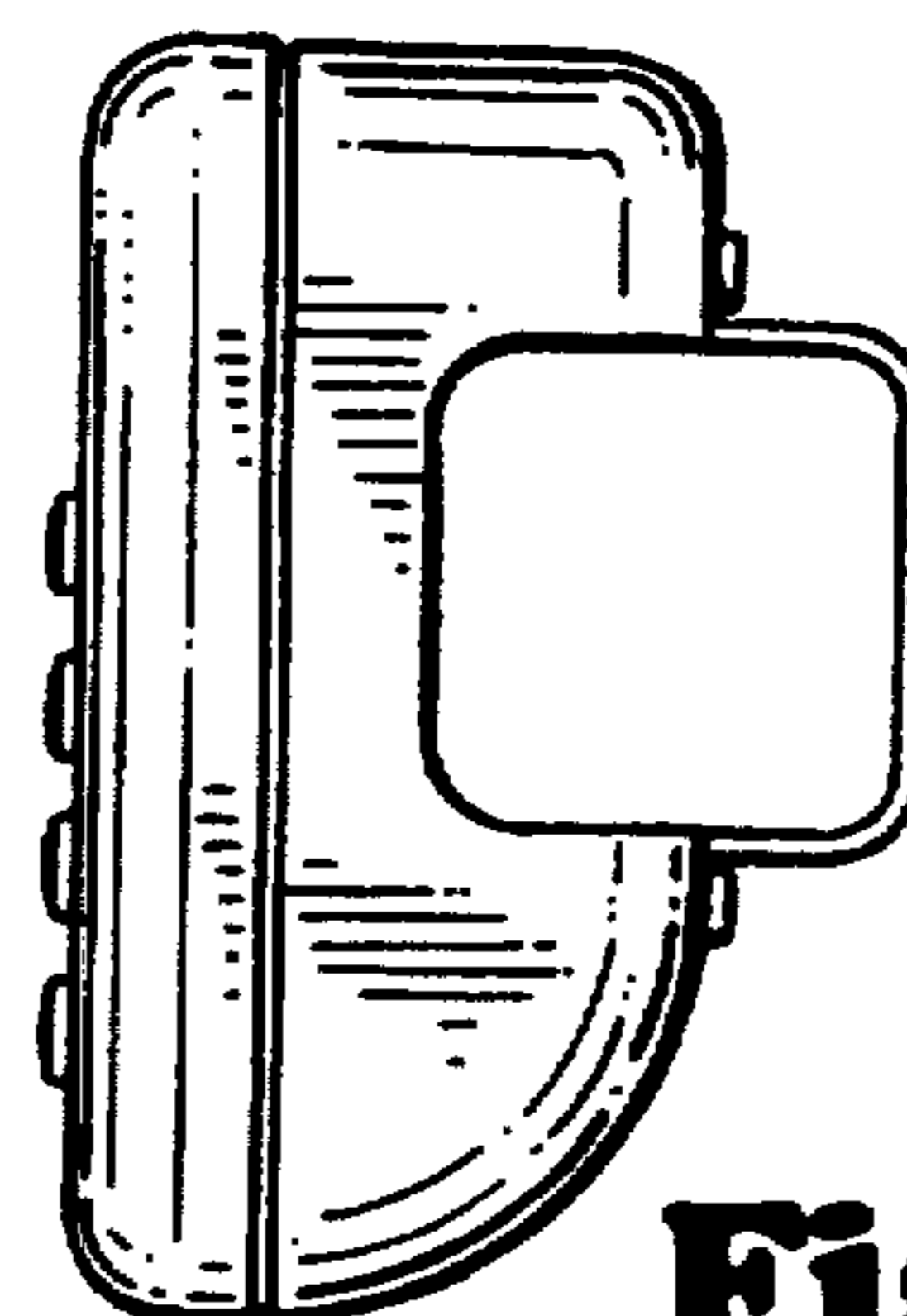

Fig. 8

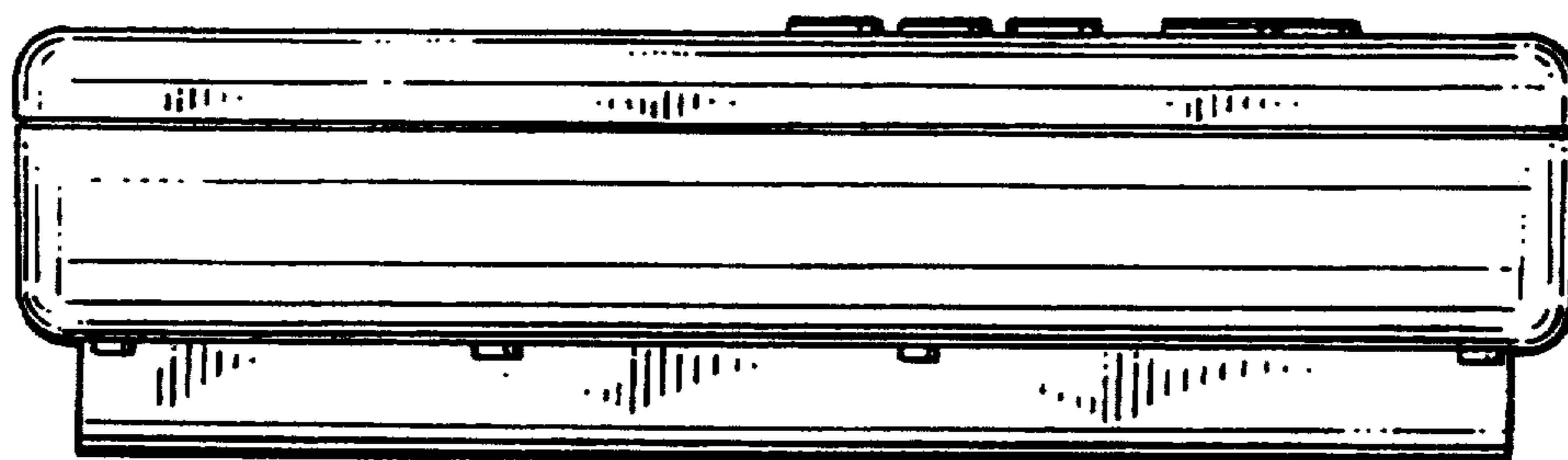

Fig. 9

Fig. 10

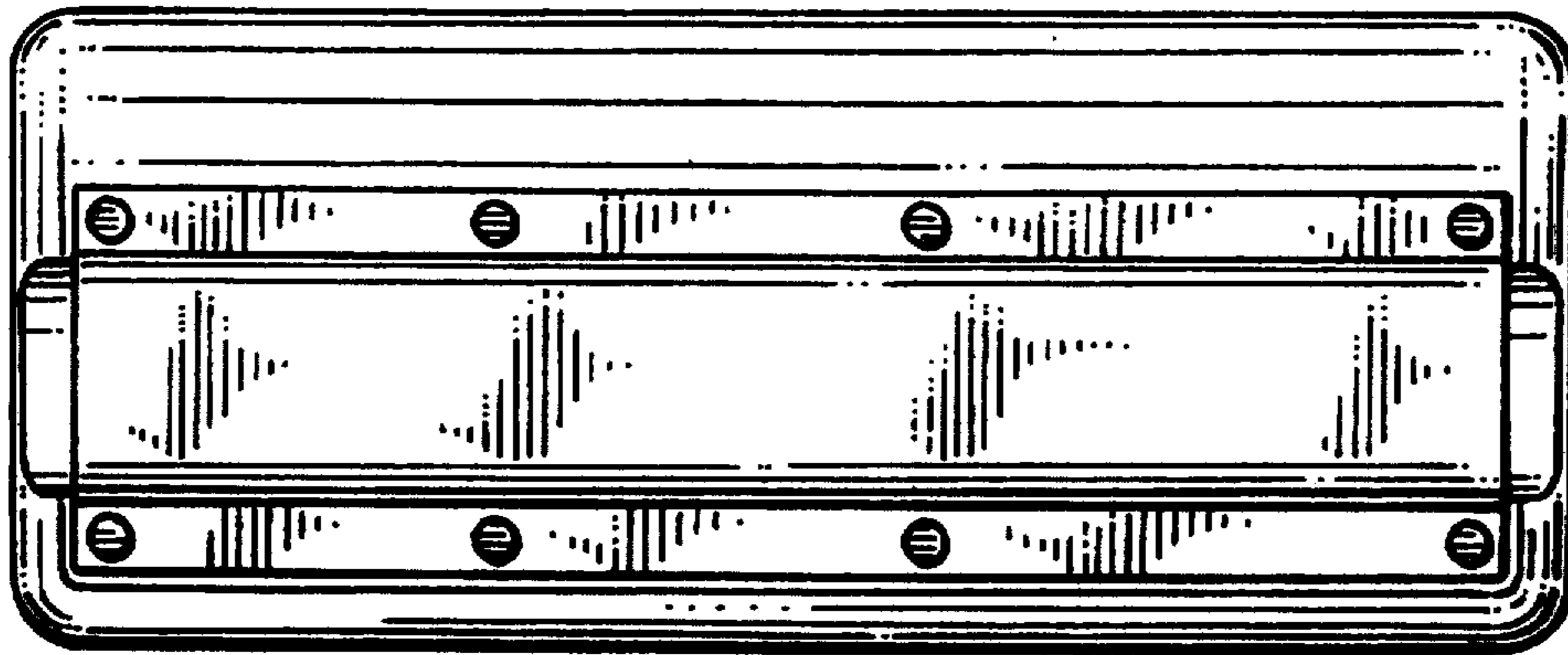
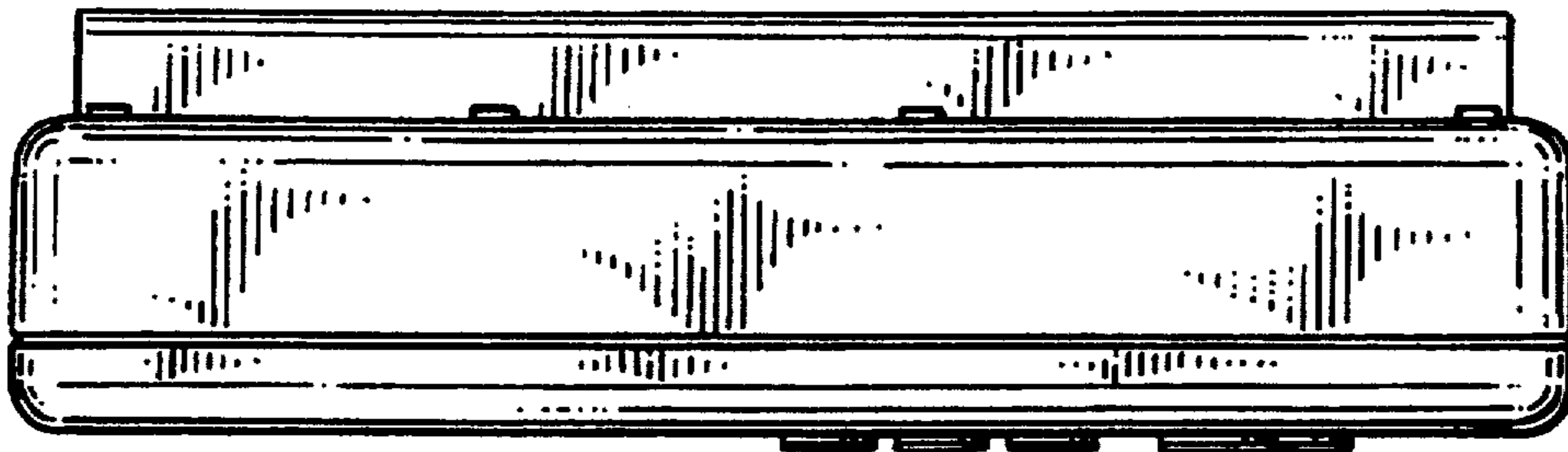

Fig. 11

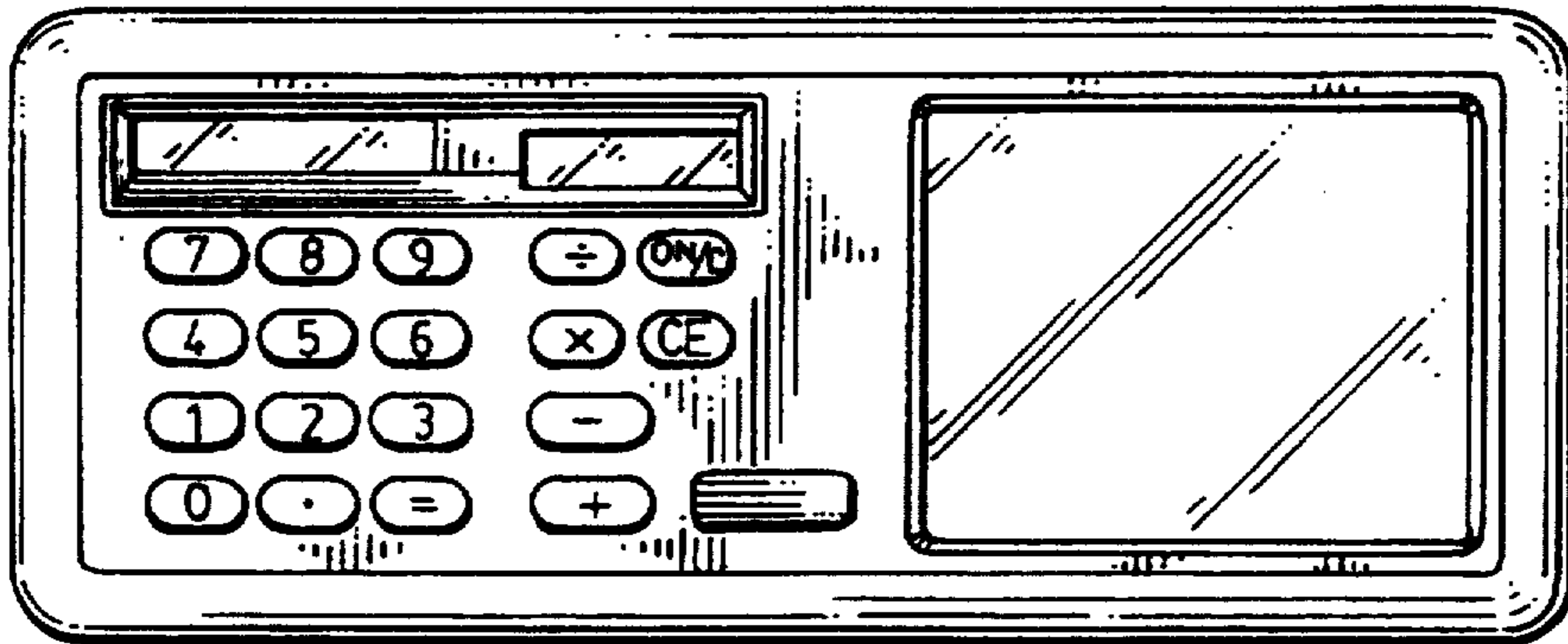

Fig. 12

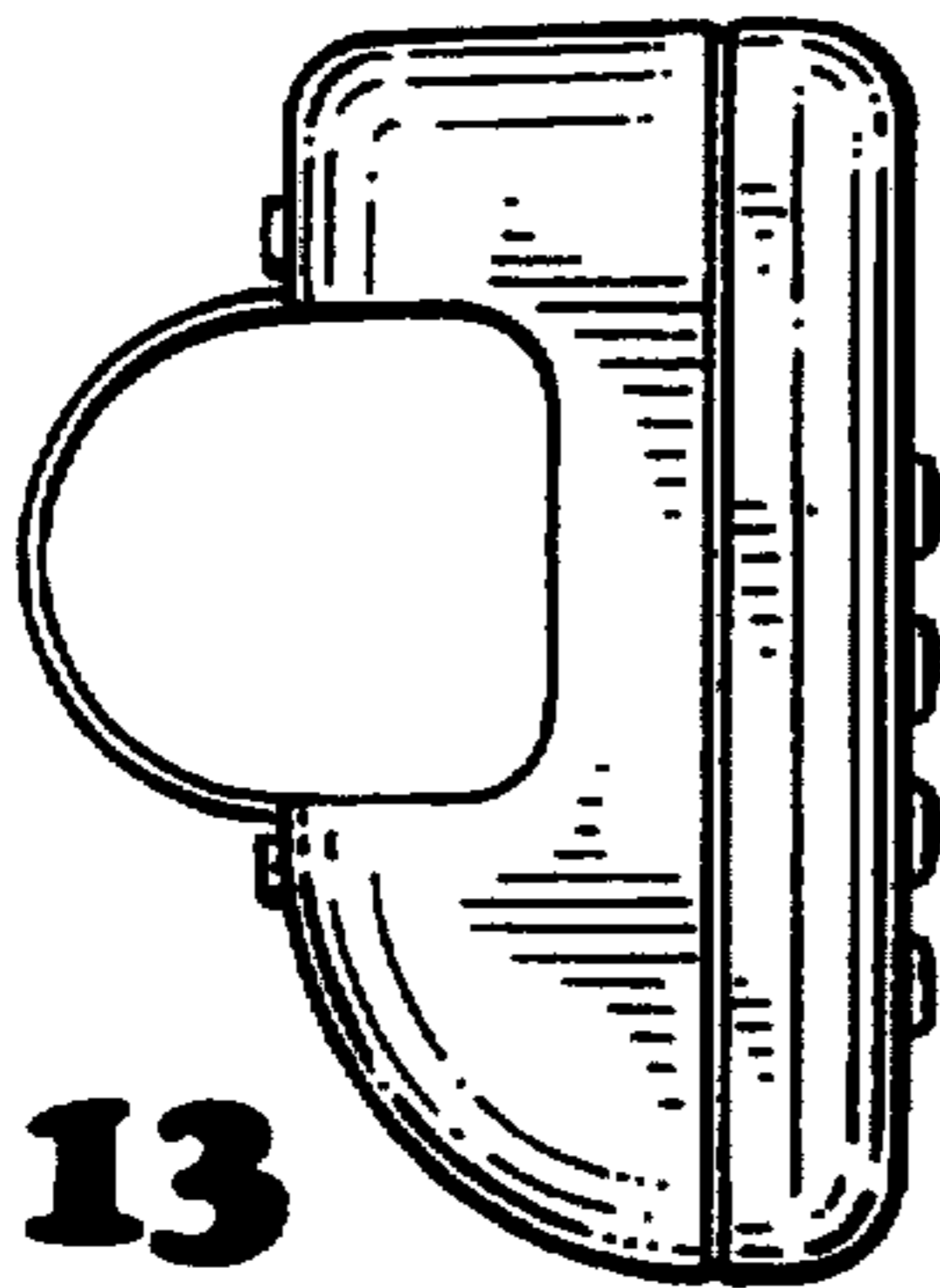

Fig. 13

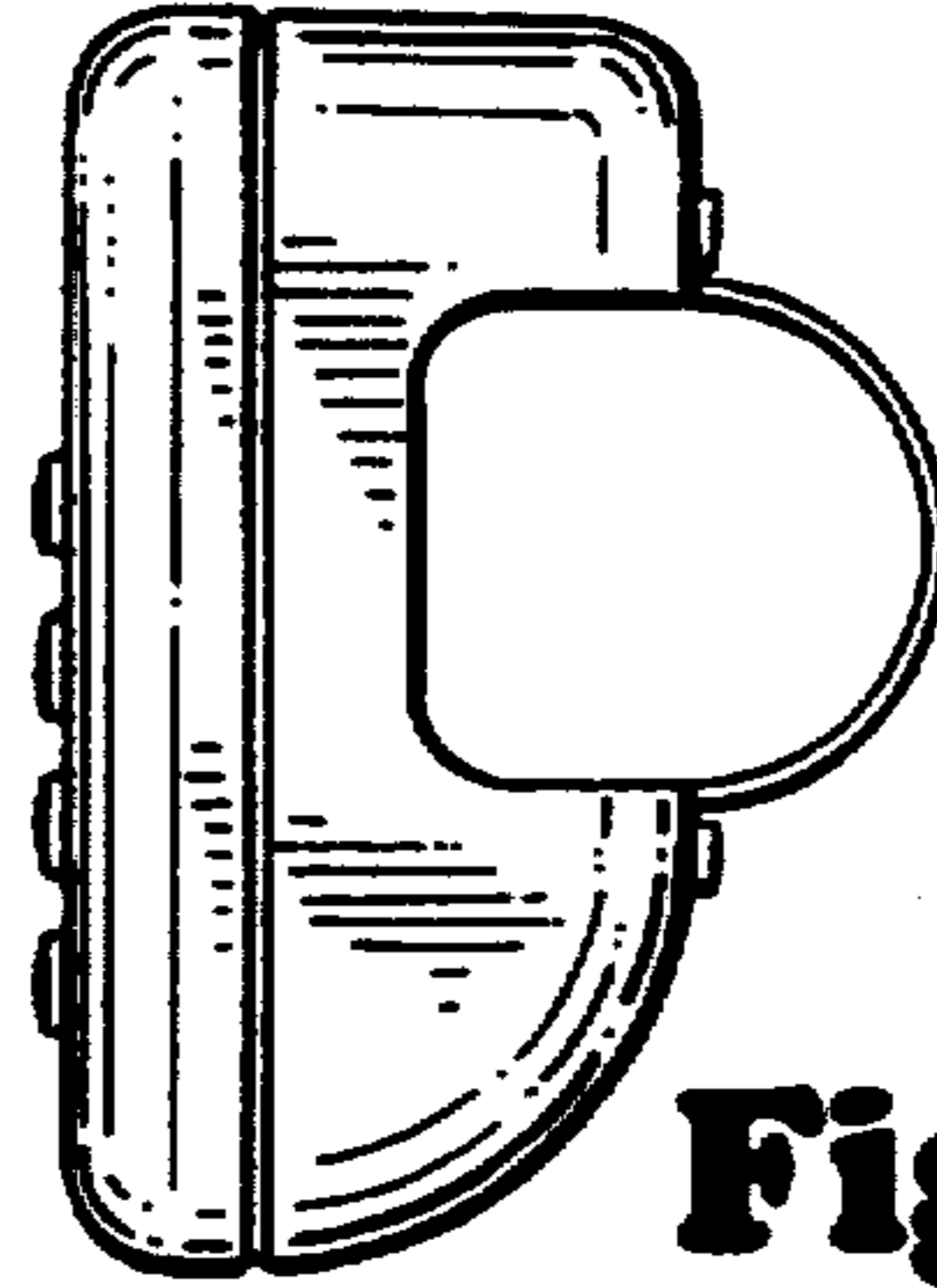

Fig. 14

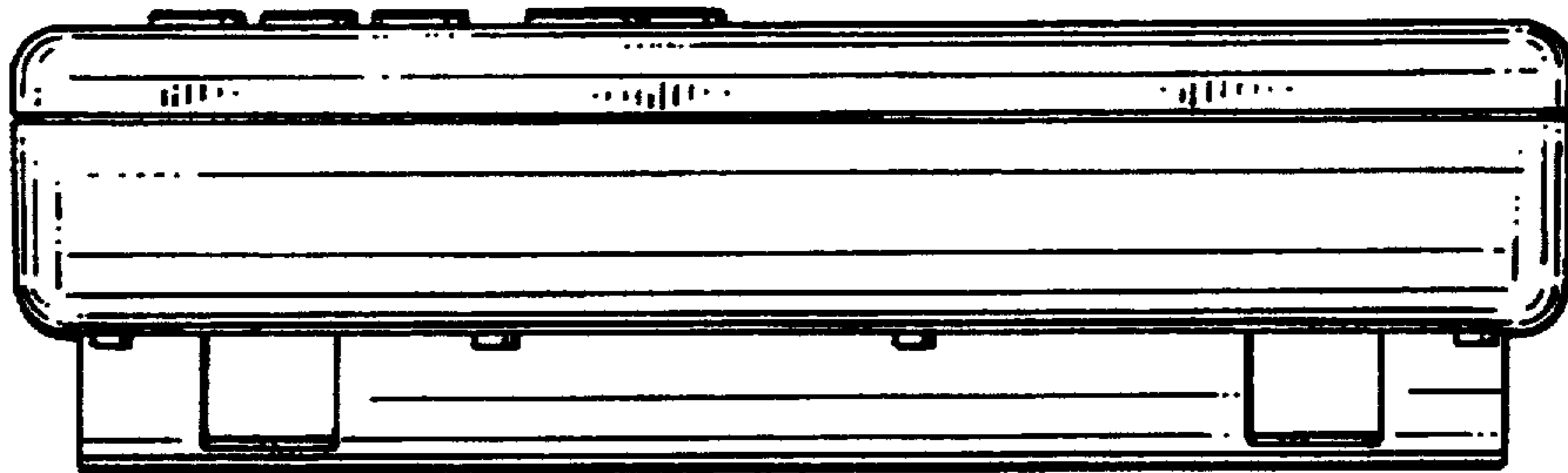

Fig. 15

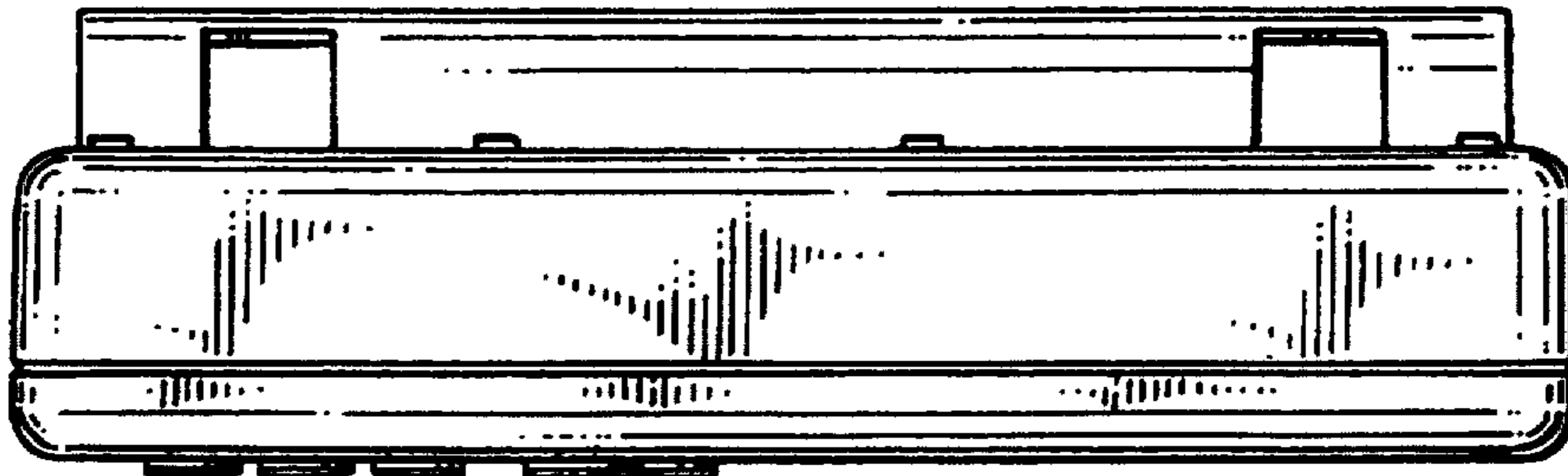

Fig. 16

Fig. 17

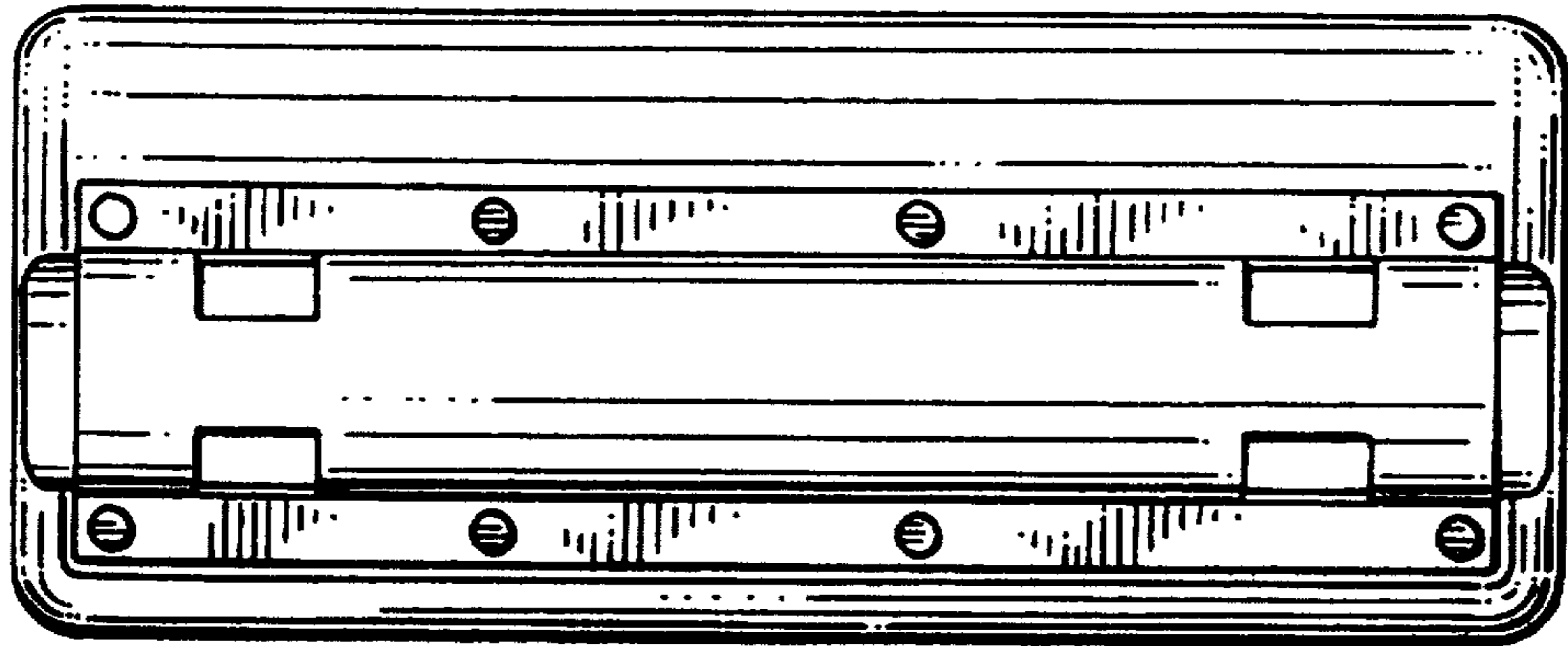

Fig. 18

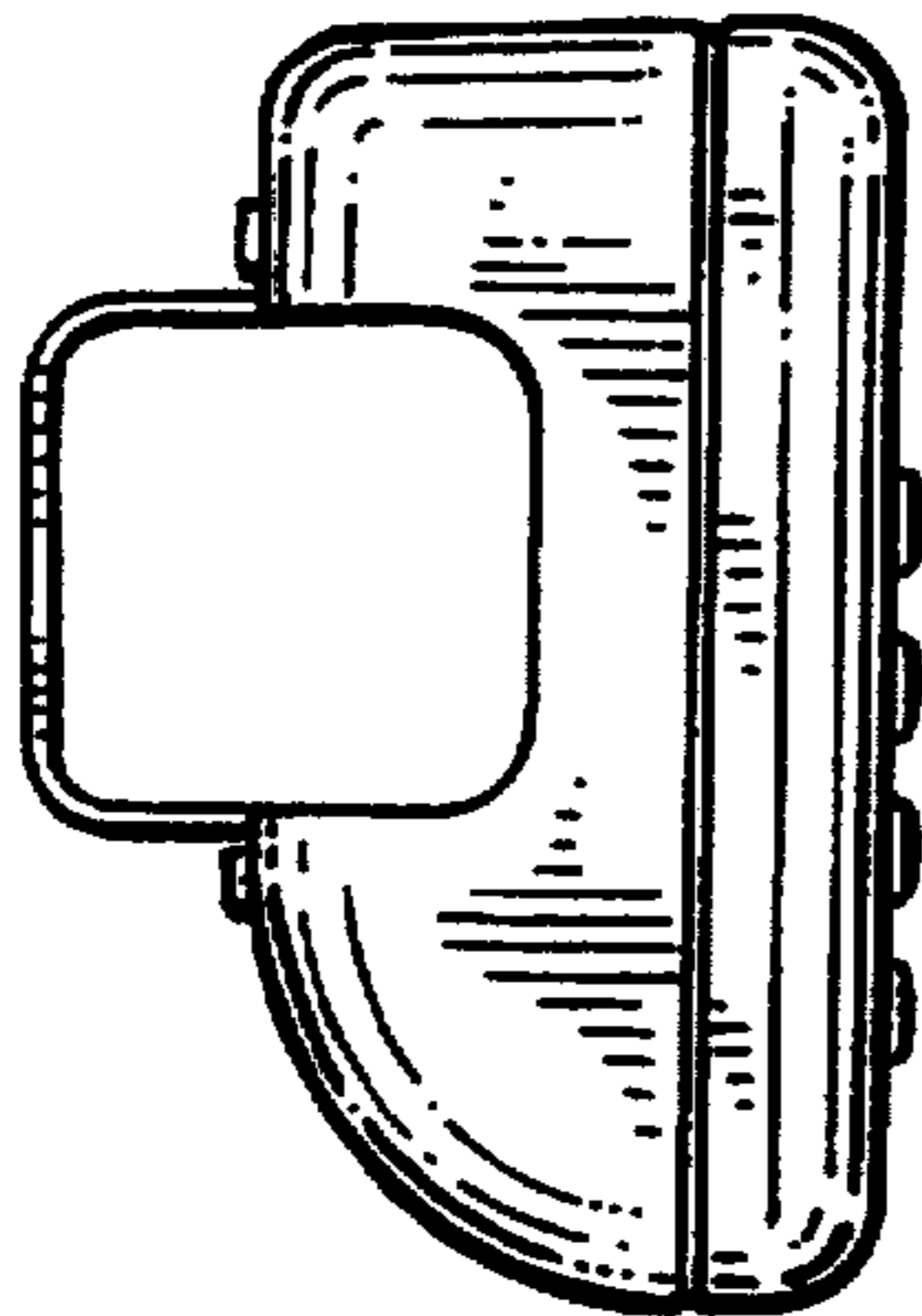

Fig. 19

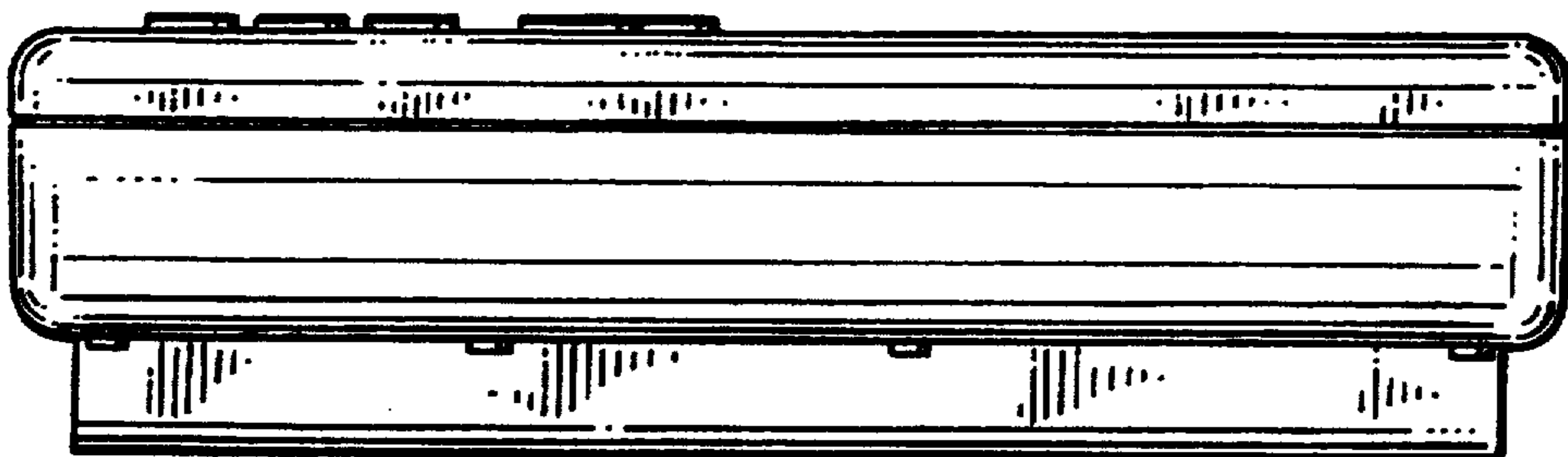
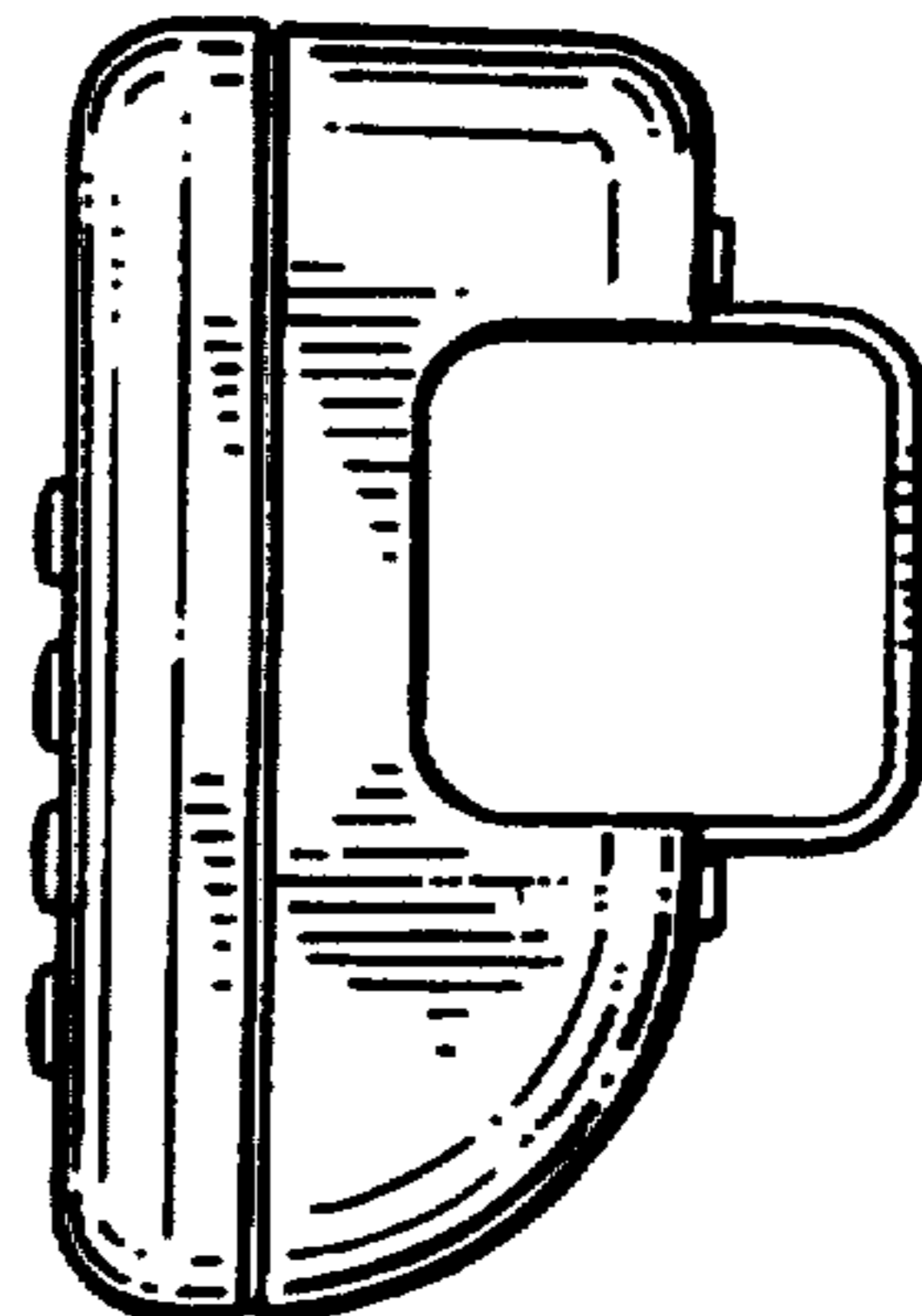

Fig. 20

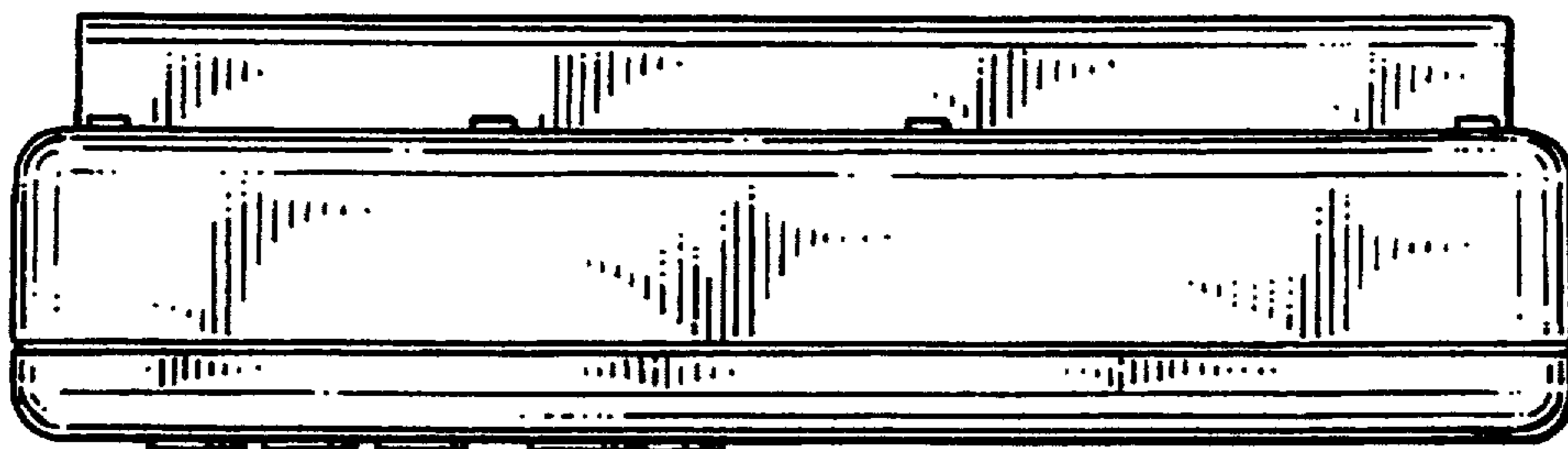

Fig. 21



Fig. 22

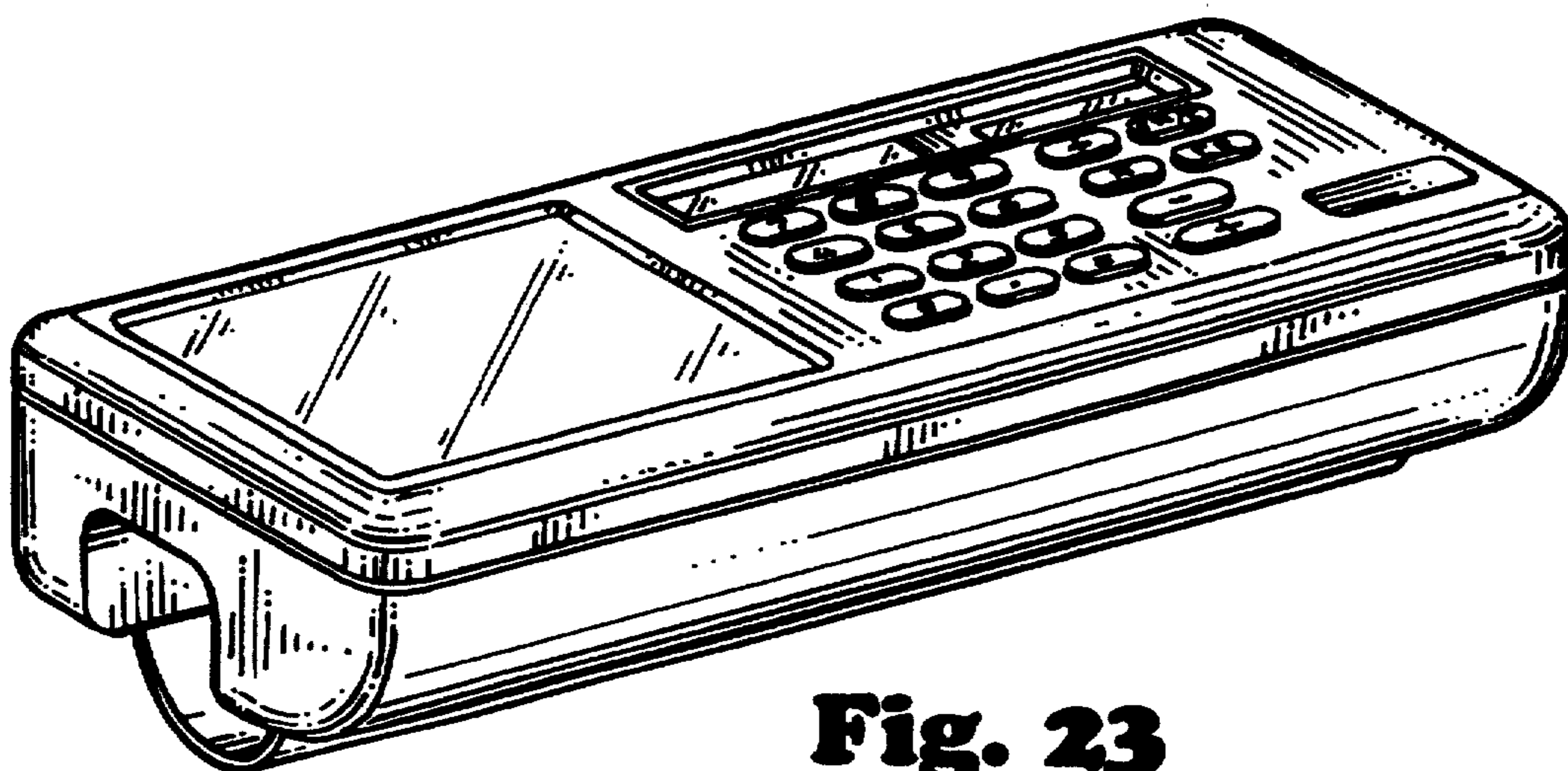

Fig. 23

UNITED STATES PATENT AND TRADEMARK OFFICE
CERTIFICATE OF CORRECTION

PATENT NO. : Des. 351,407
DATED : October 11, 1994
INVENTOR(S) : John P. Ewert

It is certified that error appears in the above-identified patent and that said Letters Patent is hereby corrected as shown below:

In the right column of the patent on the first page, in the lines that begin
"Fig. 14", "Fig. 15", "Fig. 16", "Fig. 17", "Fig. 20", "Fig. 21", and
"Fig. 22", please delete the word "alternate" in each of those lines.

Signed and Sealed this
Second Day of January, 1996



BRUCE LEHMAN

Commissioner of Patents and Trademarks

Attest:

Attesting Officer