



US00D351405S

United States Patent [19]

Hood et al.

[11] Patent Number: Des. 351,405

[45] Date of Patent: ** Oct. 11, 1994

[54] CALCULATOR WITH DUAL ADVERTISING SPACES FOR SHOPPING CART HANDLE

5,048,736 9/1991 Anatra .
5,176,392 1/1993 Graebe, Jr. D34/27 X

[75] Inventors: Charles H. Hood; John P. Ewert, both of Tulsa, Okla.

FOREIGN PATENT DOCUMENTS

8701440.8 3/1987 Fed. Rep. of Germany .

[73] Assignee: ADDvantage Media Group, Inc., Tulsa, Okla.

OTHER PUBLICATIONS

[**] Term: 14 Years

The "ShopCal" brochure.
Visual Merchandising & Store Design, May 1989, p. 63.

[21] Appl. No.: 841,086

Primary Examiner—Alan P. Douglas
Assistant Examiner—Robert M. Spear
Attorney, Agent, or Firm—Arnold, White & Durkee

[22] Filed: Mar. 2, 1992

[52] U.S. Cl. D18/7

[58] Field of Search 235/1 D, 1 R; D18/1, D18/2, 6, 7, 11; D34/21, 27

[57] CLAIM

The ornamental design for a calculator with dual advertising spaces for shopping cart handle, as shown and described.

[56] References Cited

U.S. PATENT DOCUMENTS

- D. 227,770 7/1973 Yamamoto .
- D. 287,730 12/1986 Stoll .
- D. 321,577 11/1991 Ellis et al. .
- D. 328,607 8/1992 Brennan D18/7
- 3,251,543 5/1966 Bush 235/1 R
- 3,314,601 4/1967 Voo .
- 4,334,278 6/1982 Marmon .
- 4,446,528 5/1984 Marmon .
- 4,450,994 5/1984 Holland .
- 4,454,414 6/1984 Benton .
- 4,458,320 7/1984 Sutton .
- 4,496,058 1/1985 Harris .
- 4,512,504 4/1985 Owlett .
- 4,685,701 8/1987 Amundson .
- 4,802,575 2/1989 Martin .
- 4,858,353 8/1989 Krebs .
- 4,892,192 1/1990 Hague .
- 4,901,901 2/1990 Reitenour .
- 4,954,003 9/1990 Shea .

DESCRIPTION

FIG. 1 is a front view of a calculator with dual advertising spaces for shopping cart handle, showing our new design;

FIG. 2 is a left side view;

FIG. 3 is a right side view;

FIG. 4 is a bottom view;

FIG. 5 is a top view;

FIG. 6 is a rear view;

FIG. 7 is a left side view of a second embodiment of my new design, the front view thereof being identical to that of FIG. 1;

FIG. 8 is a right side view of the second embodiment;

FIG. 9 is a bottom view of the second embodiment;

FIG. 10 is a top view of the second embodiment;

FIG. 11 is a rear view of the second embodiment; and,

FIG. 12 is a perspective view of the embodiment of FIG. 1.

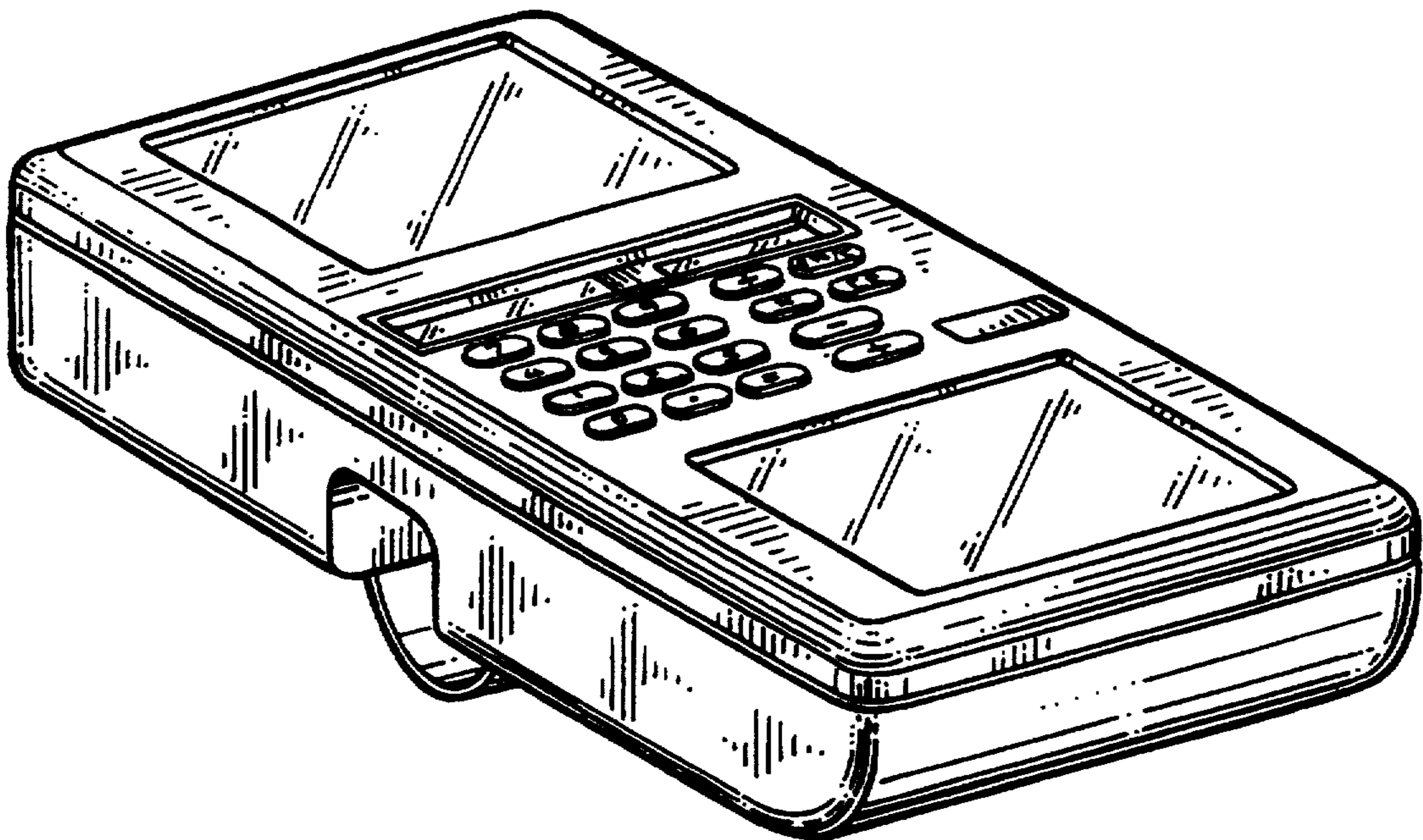

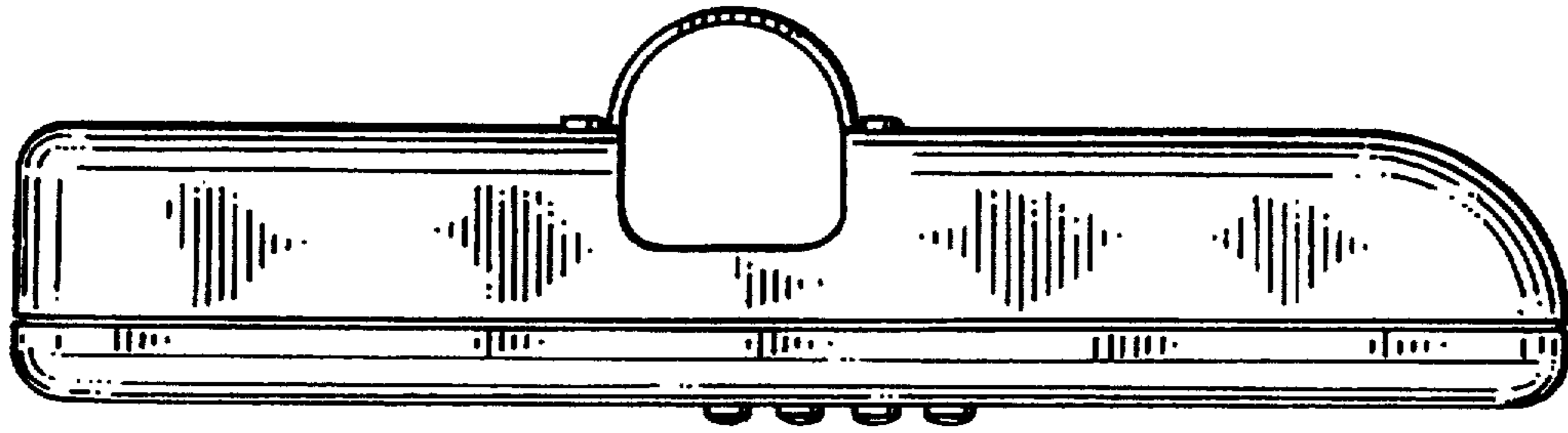

Fig. 3

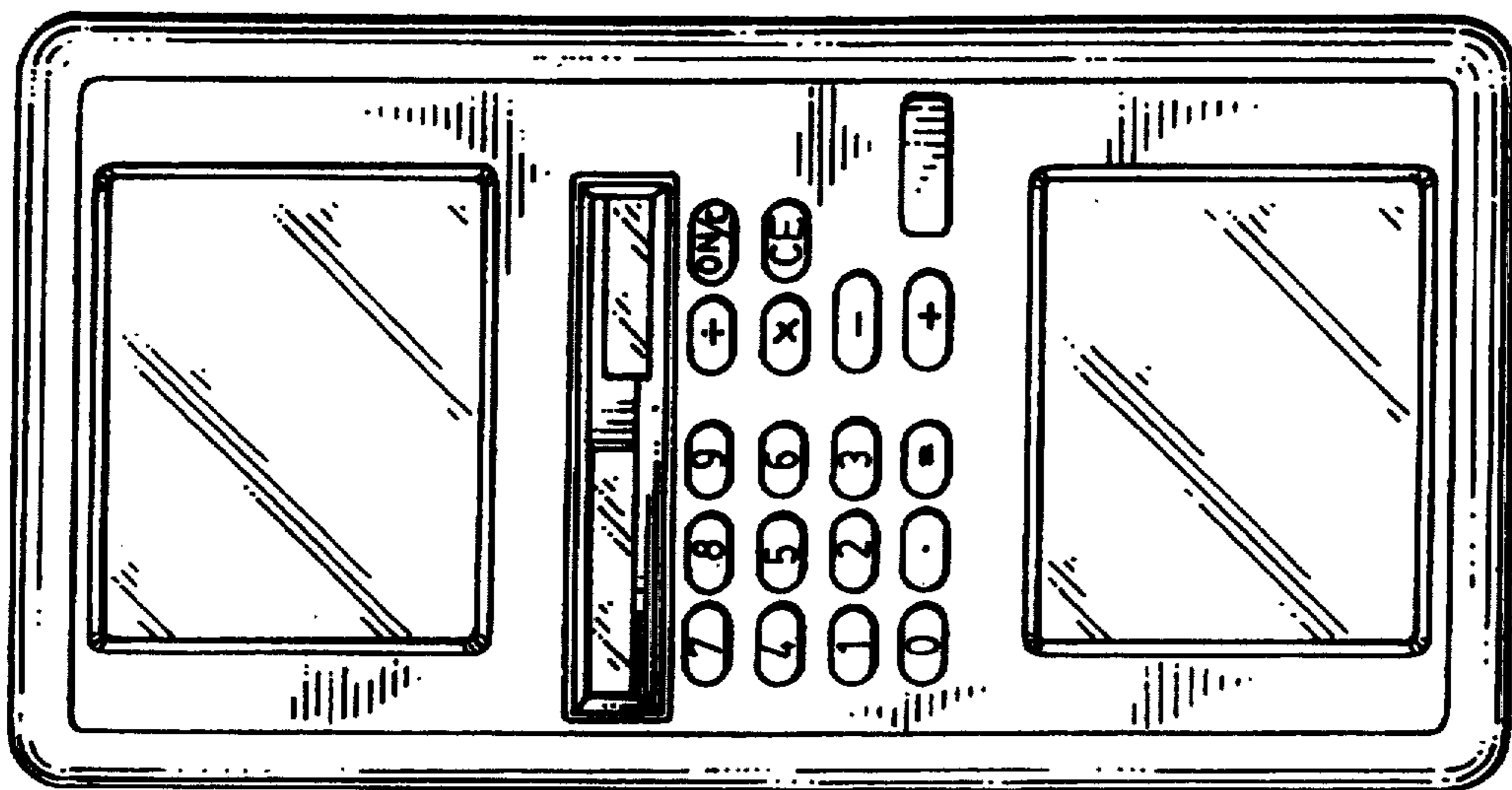

Fig. 1

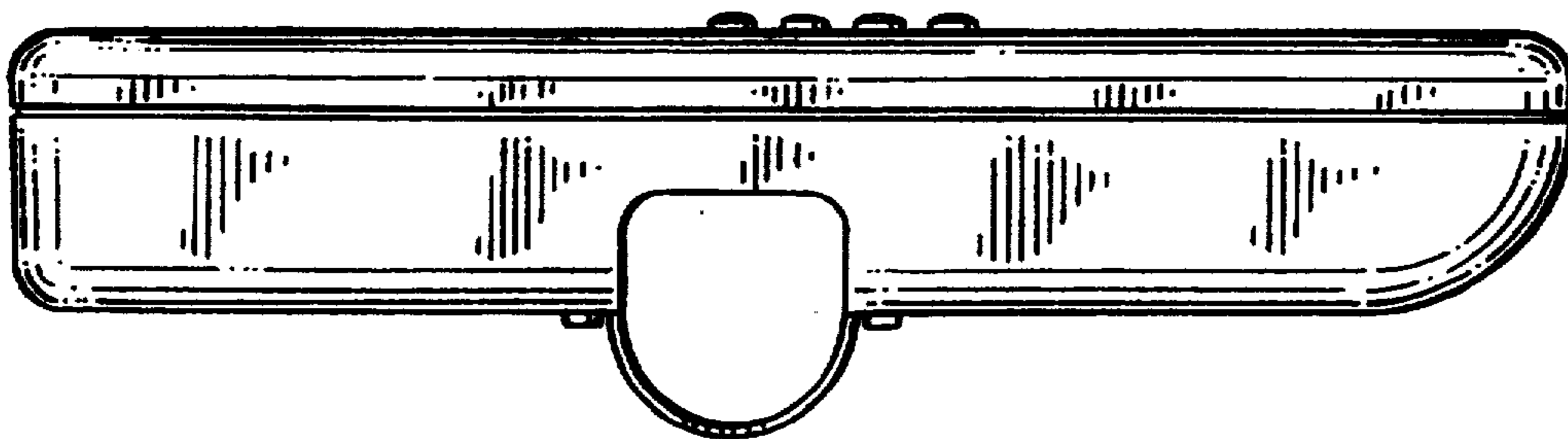

Fig. 2

Fig. 8

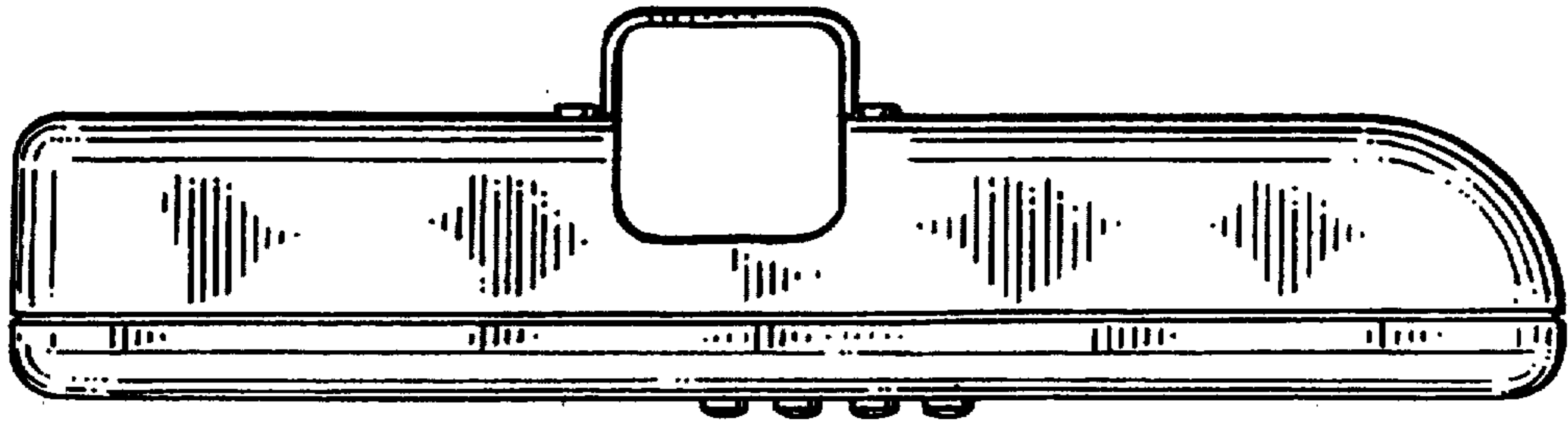

Fig. 7

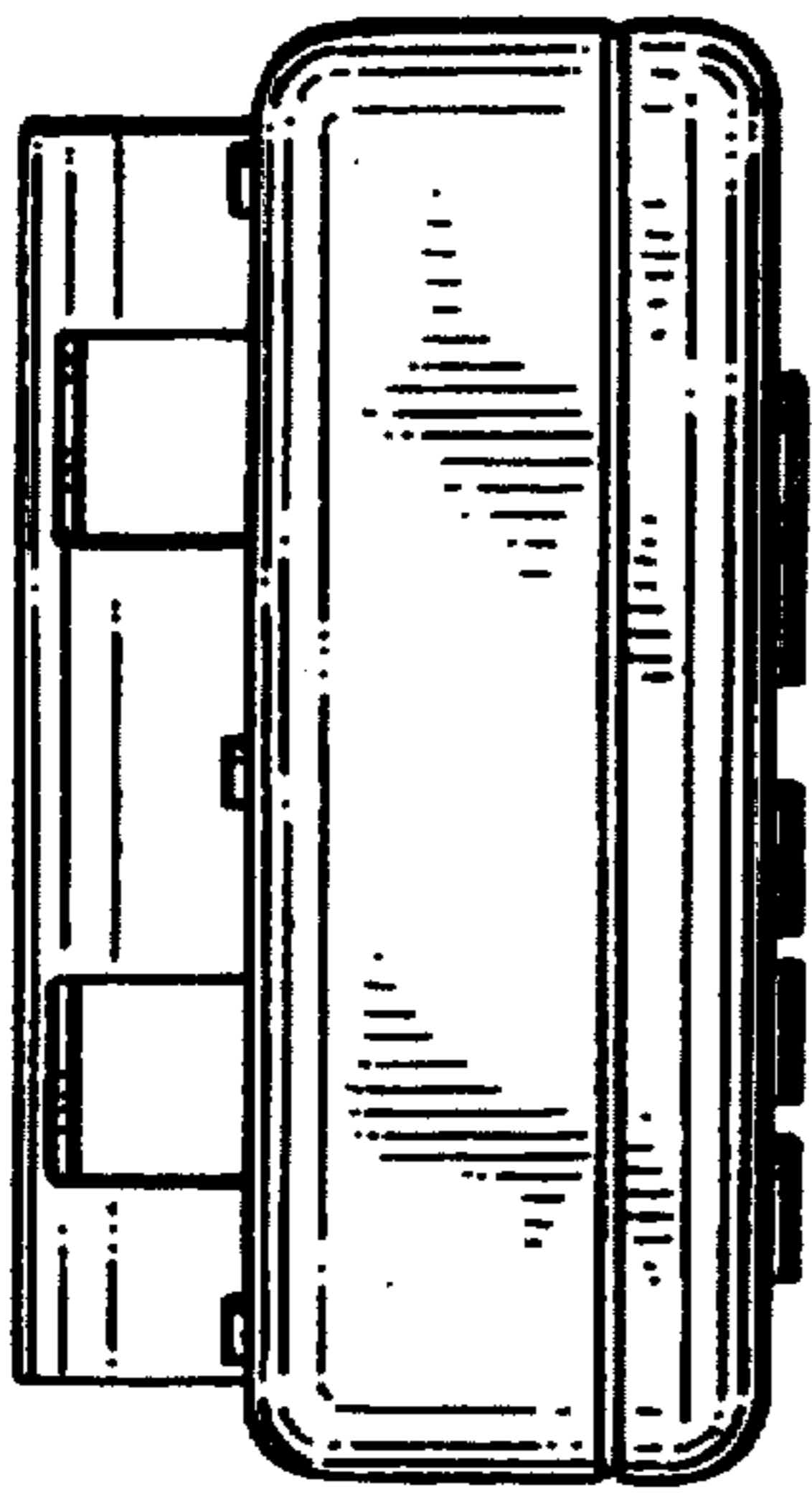
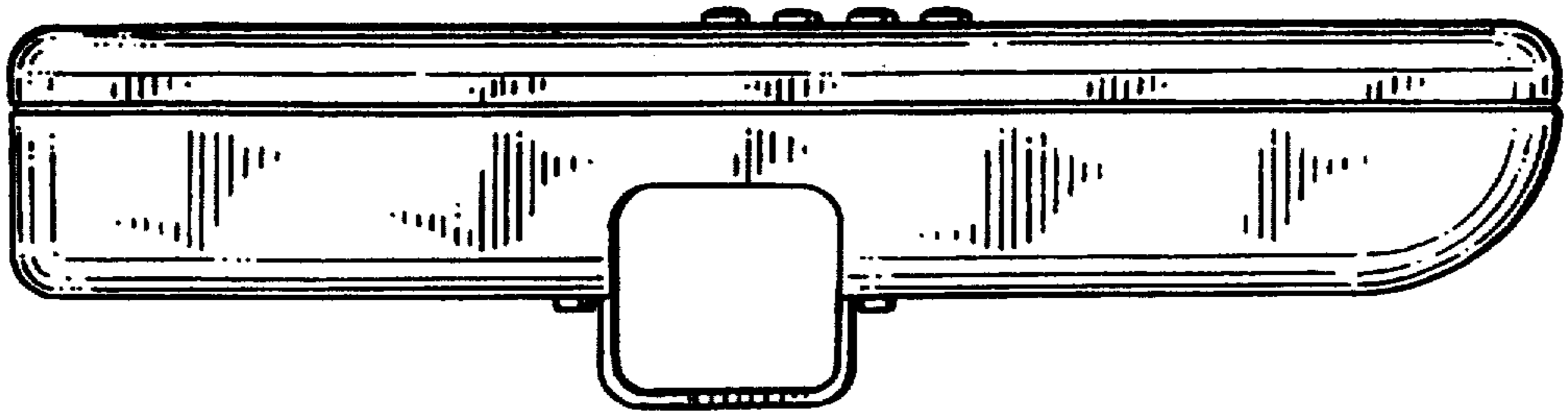

Fig. 5



Fig. 10

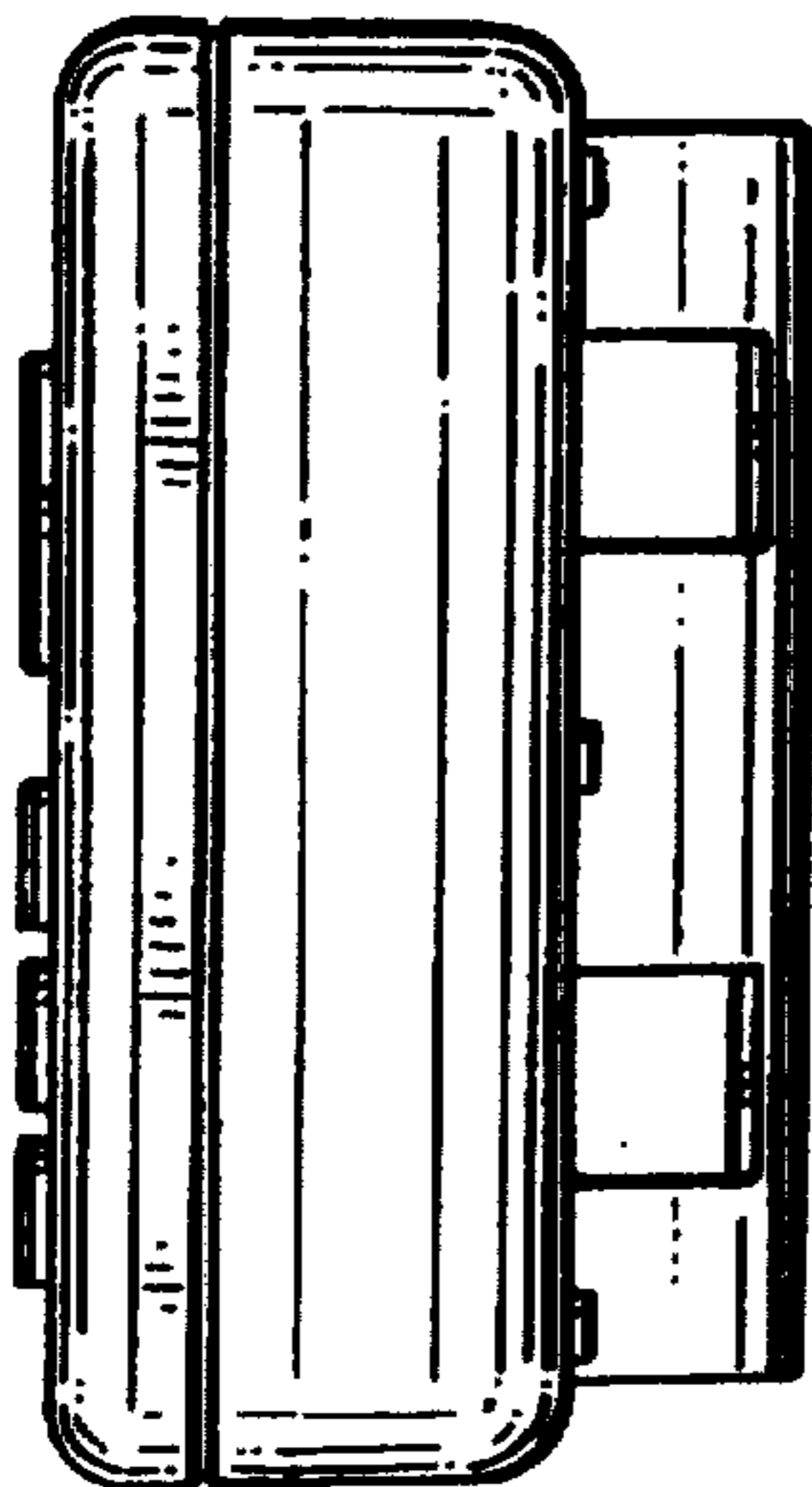

Fig. 4

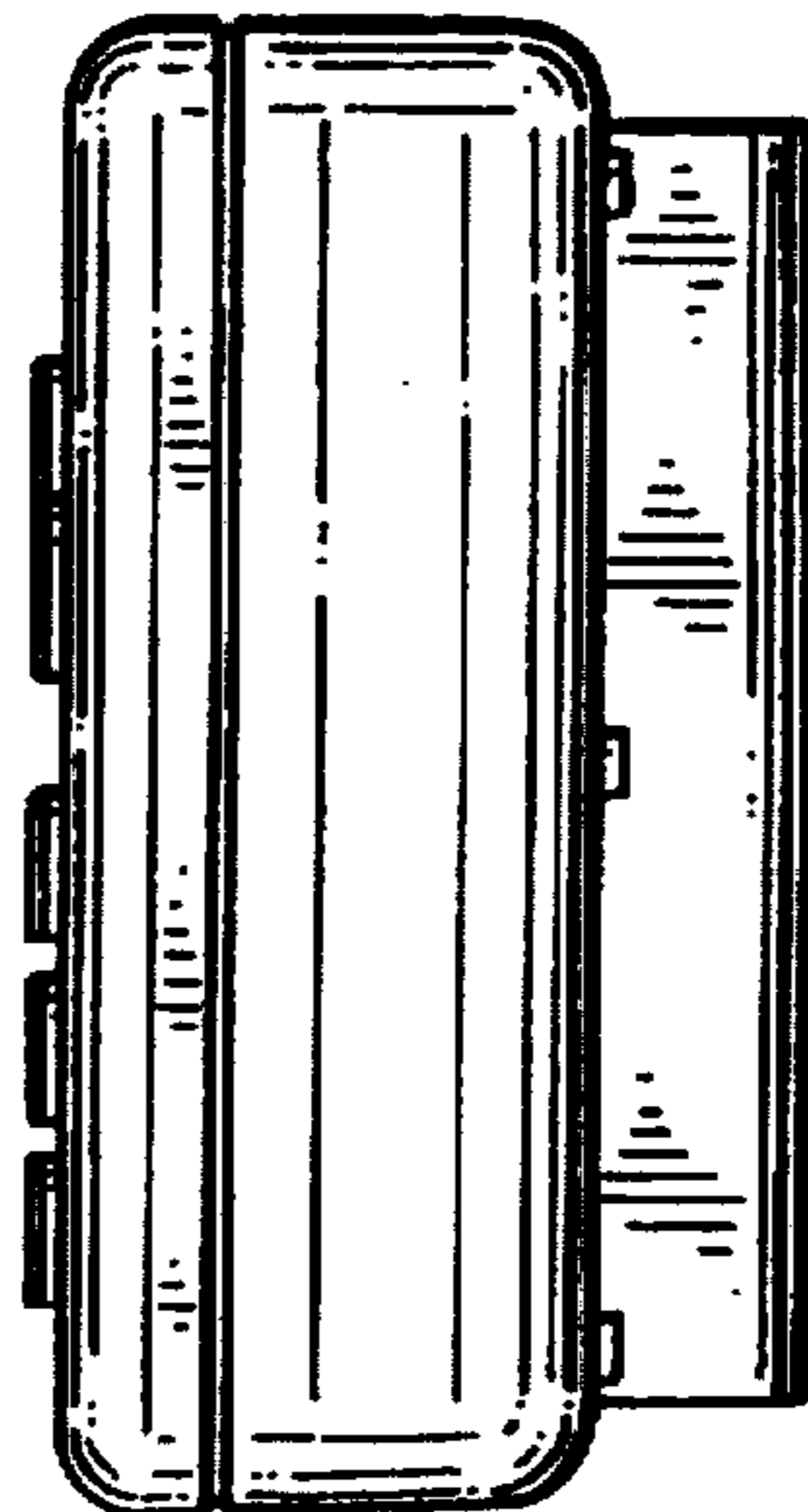

Fig. 9

Fig. 11

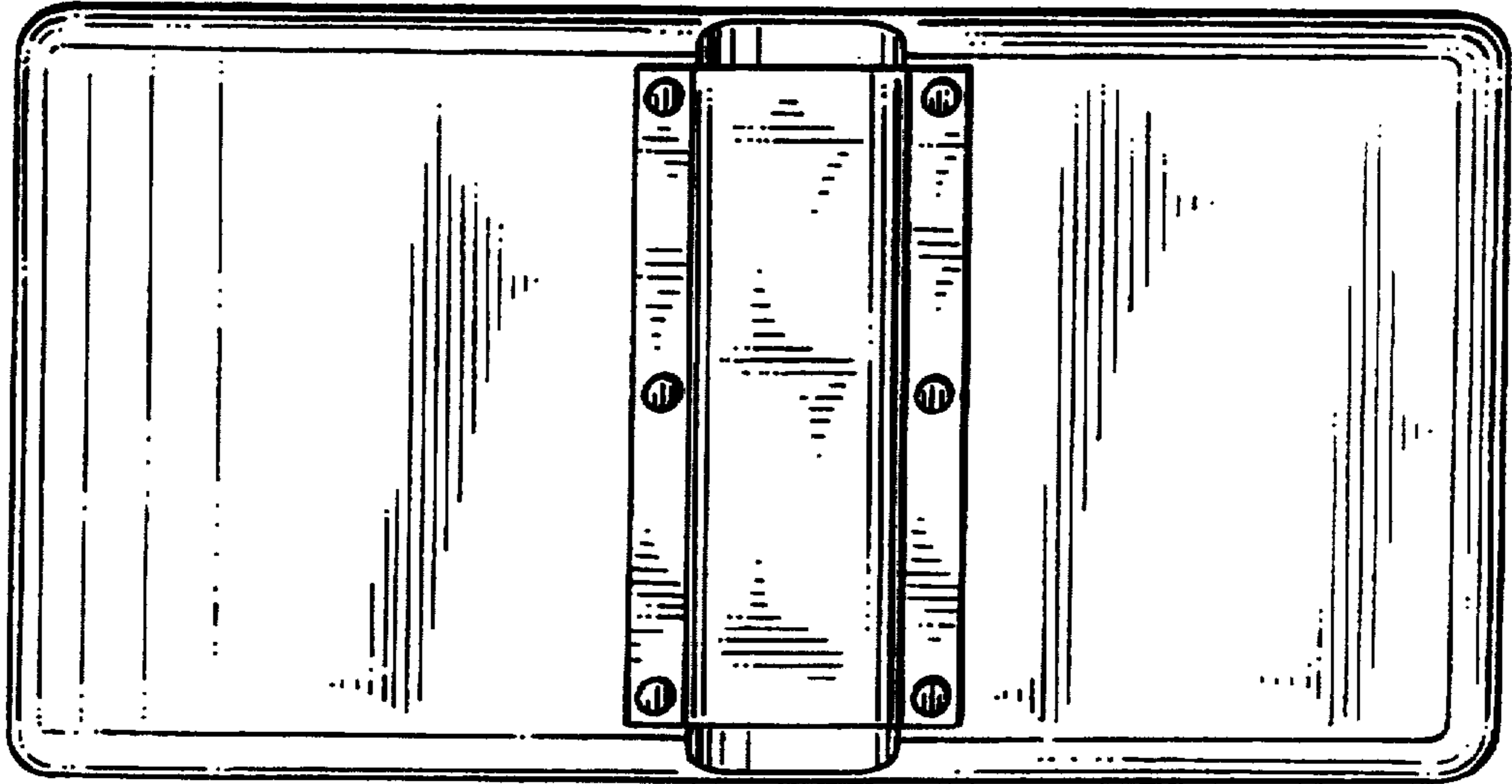

Fig. 6

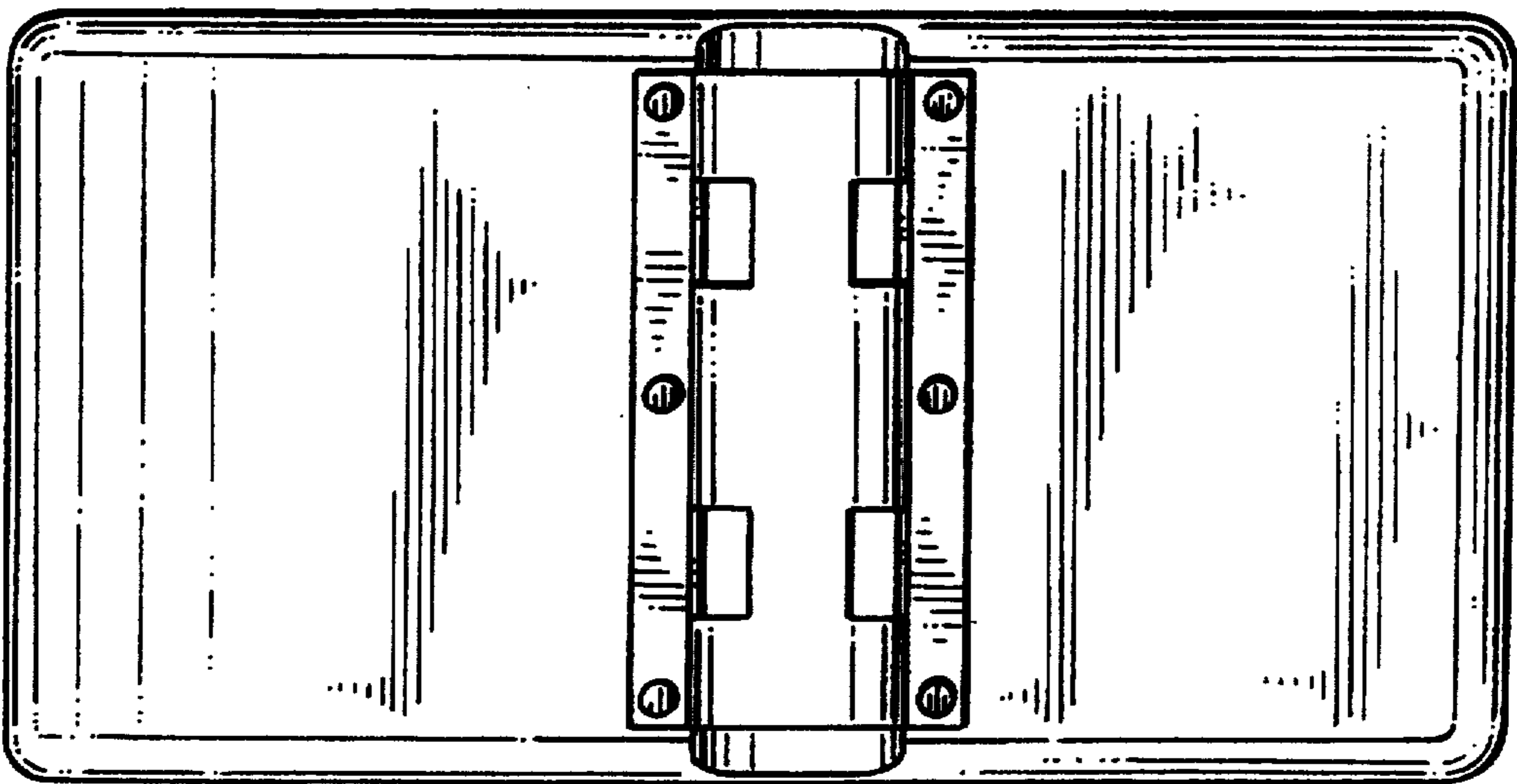

Fig. 12

