



US00D351394S

United States Patent [19]
Morris

[11] **Patent Number: Des. 351,394**

[45] **Date of Patent: ** Oct. 11, 1994**

- [54] **OIL RECYCLING CONTAINER**
- [75] **Inventor: Michael A. Morris, Menlo Park, Calif.**
- [73] **Assignee: Geo Plastics, Redwood City, Calif.**
- [**] **Term: 14 Years**
- [21] **Appl. No.: 8,373**
- [22] **Filed: May 17, 1993**
- [52] **U.S. Cl. D15/152**
- [58] **Field of Search D7/543, 500, 700; 141/98, 339; 220/571-573; D15/150, 151, 152; D23/209**

Assistant Examiner—Antoine D. Davis
Attorney, Agent, or Firm—Flehr, Hohbach, Test, Albritton & Herbert

[57] **CLAIM**

The ornamental design for an oil recycling container, as shown and described.

DESCRIPTION

FIG. 1 is a top perspective view showing my new design;
 FIG. 2 is an end elevation view of one end thereof;
 FIG. 3 is a side elevation view of one side thereof;
 FIG. 4 is an end elevation view of the opposite end thereof;
 FIG. 5 is a side elevation view of the opposite side thereof;
 FIG. 6 is a top plan view thereof;
 FIG. 7 is a bottom plan view thereof;
 FIG. 8 is a cross-sectional view taken along line 8—8 of FIG. 6; and,
 FIG. 9 is a cross-sectional view taken along line 9—9 of FIG. 6 thereof.

The broken line showing of the cap is for illustrative purposes only and forms no part of the claimed design.

- [56] **References Cited**
- U.S. PATENT DOCUMENTS**
- 4,488,584 12/1984 Hestchave et al. 220/573 X
- 4,632,268 12/1986 Melzi et al. 220/573
- 4,673,081 6/1987 Habig et al. 220/573 X
- 4,881,650 11/1989 Bartz 220/573
- 4,969,571 11/1990 Bartz 220/573 X
- 5,285,824 2/1994 Krstovic 220/573 X

Primary Examiner—Alan P. Douglas

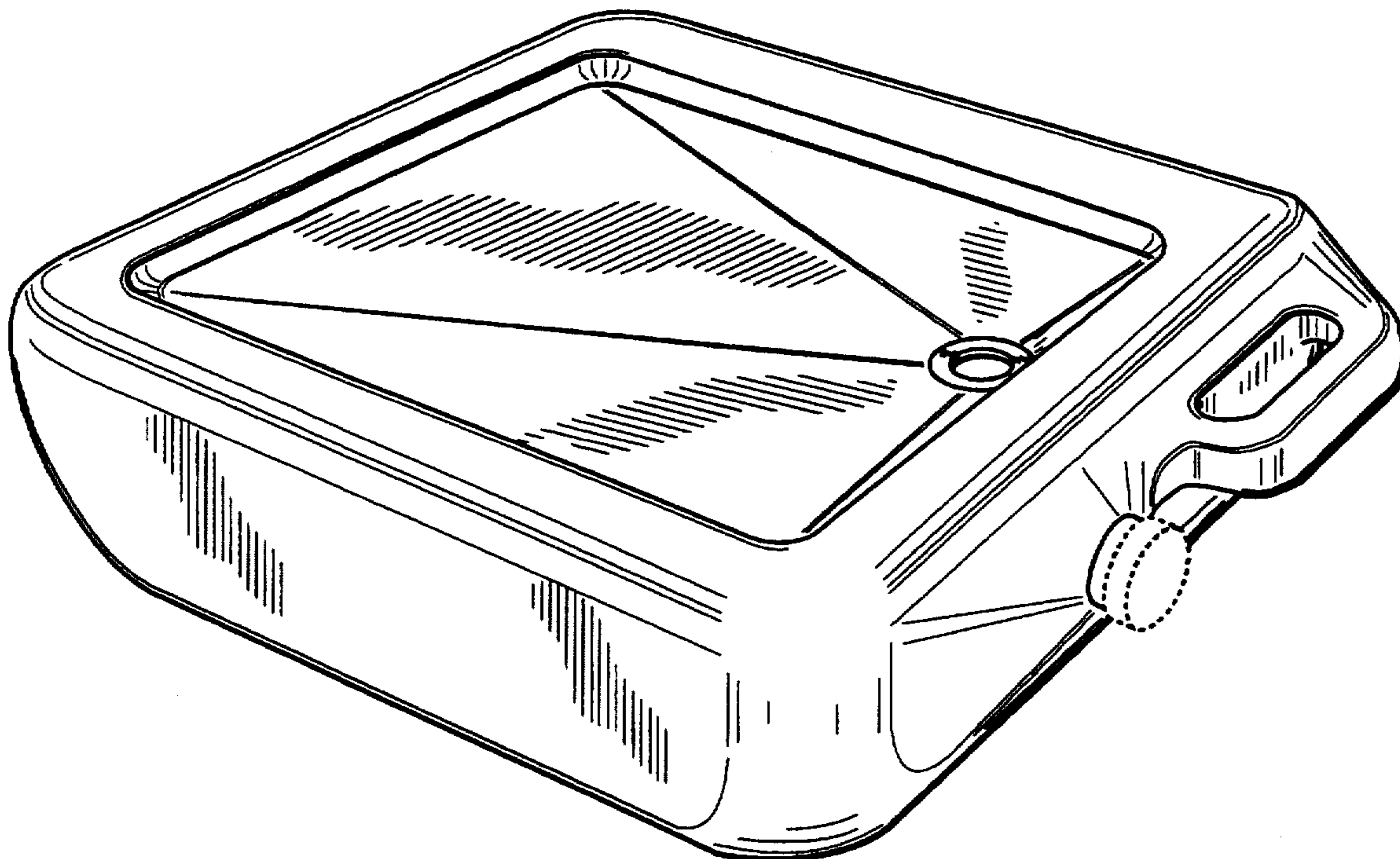

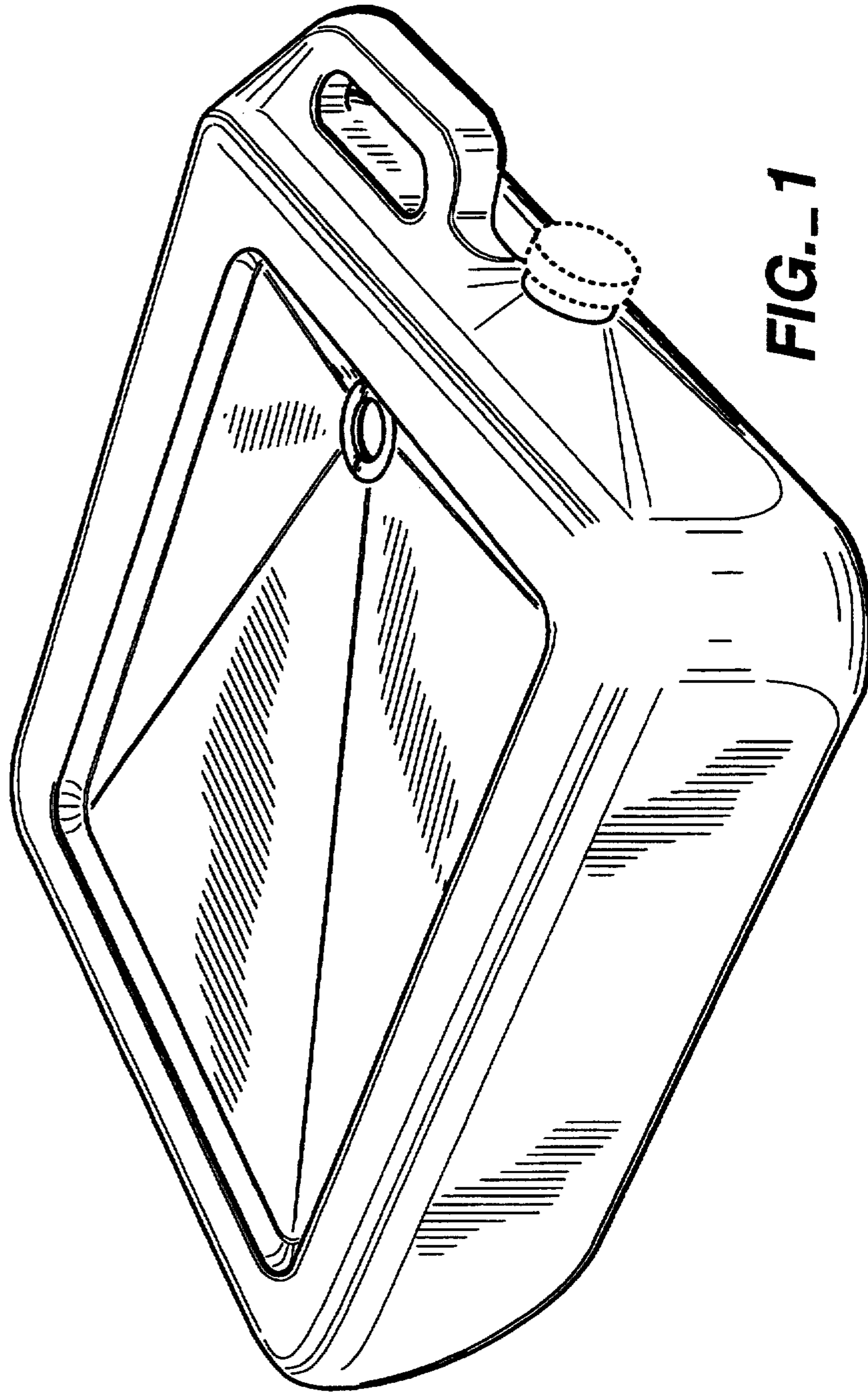

FIG. 1

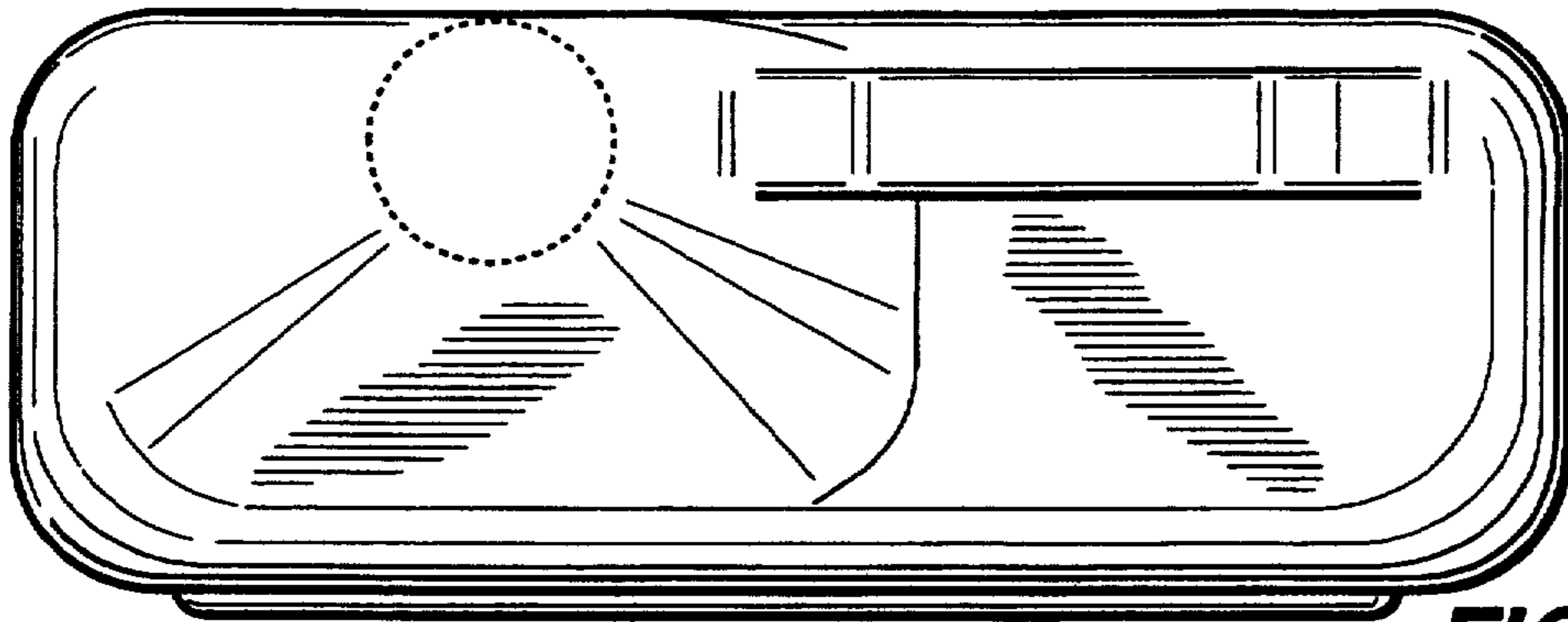

FIG. 2

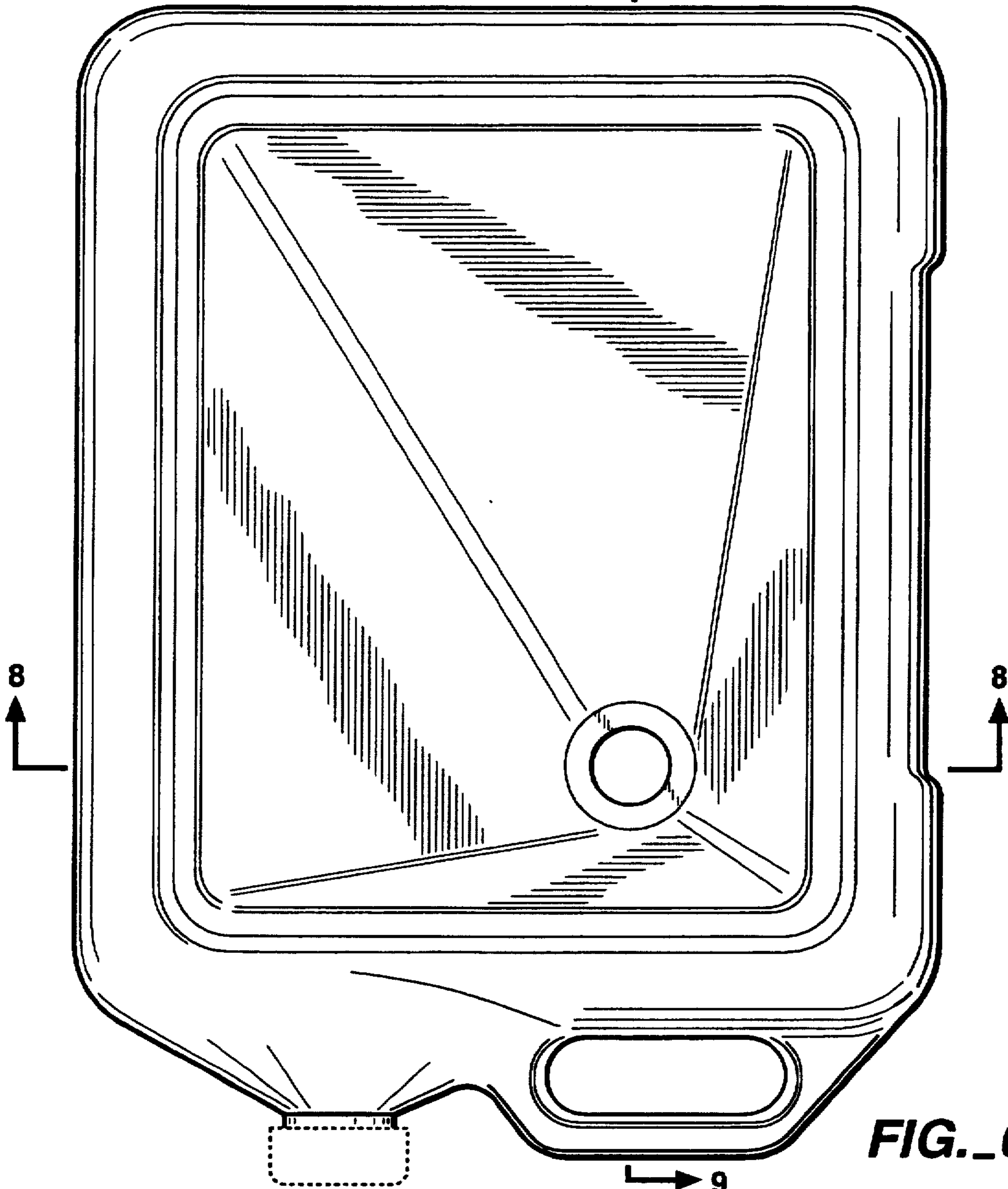

FIG. 6



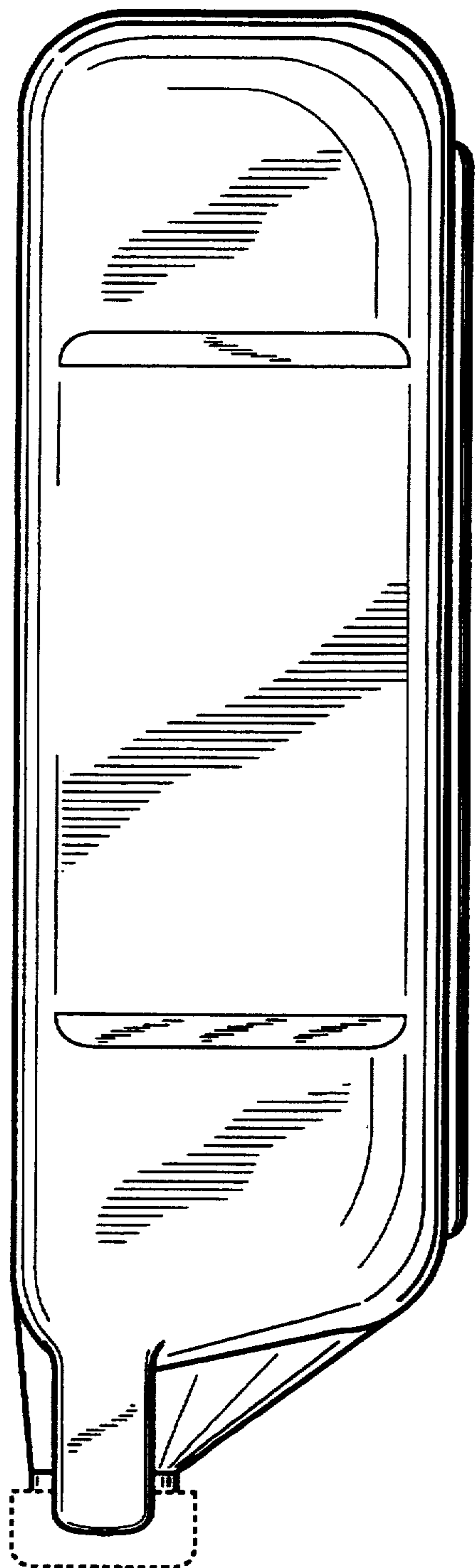

FIG. 3

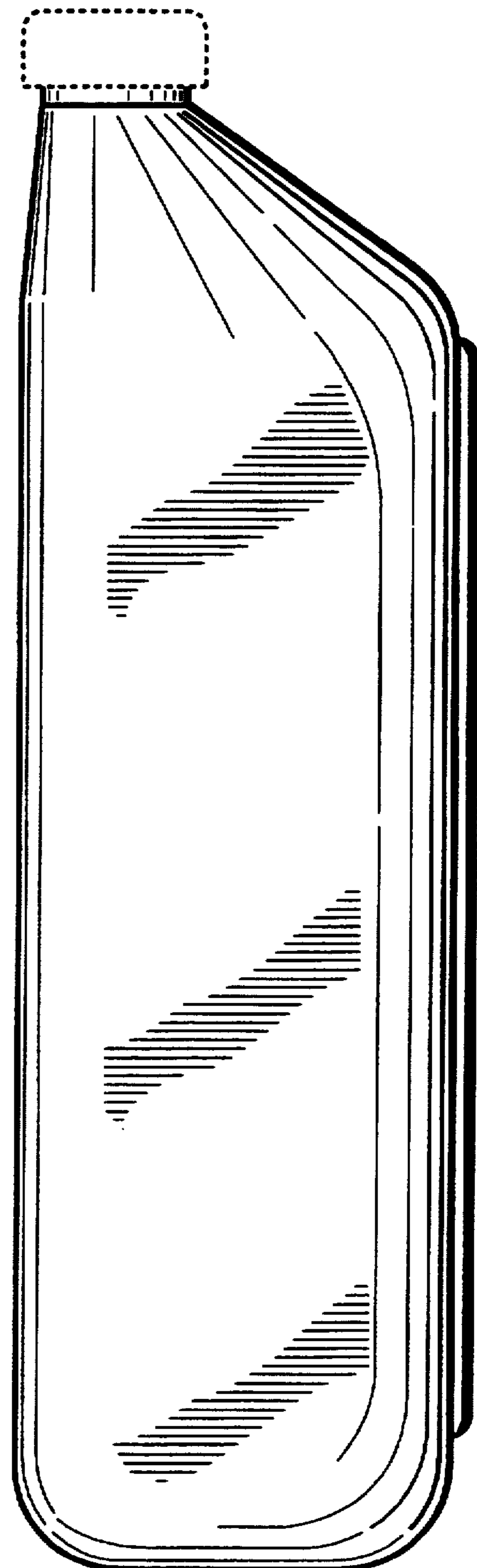

FIG. 5

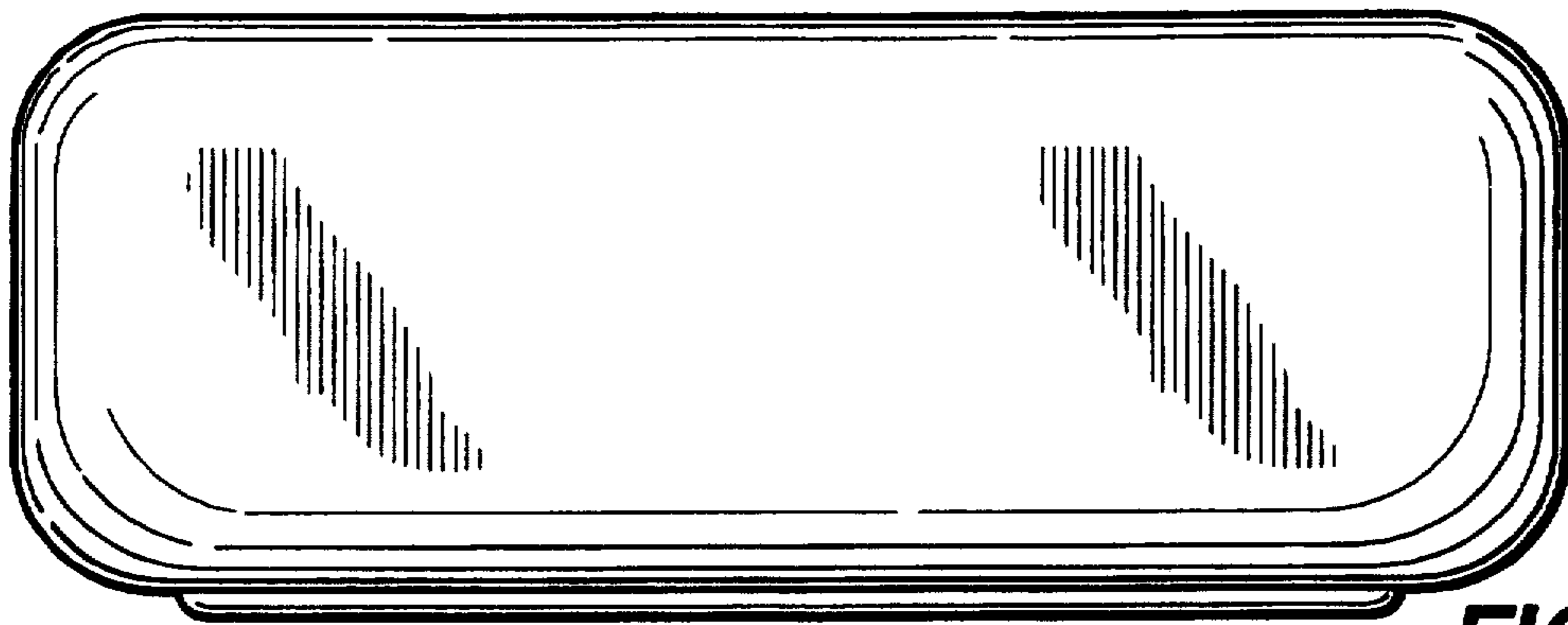

FIG._4

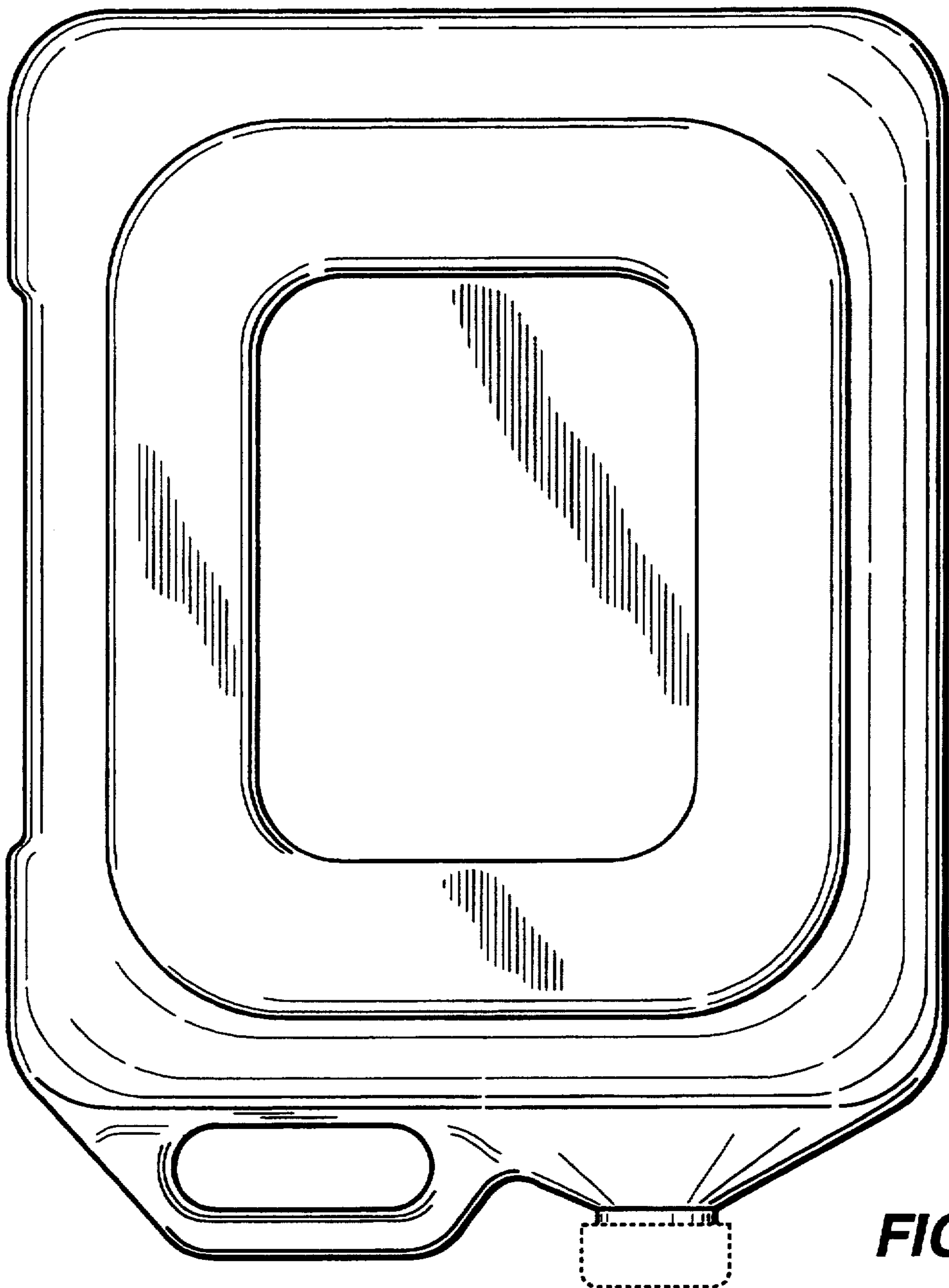

FIG._7

FIG. 8

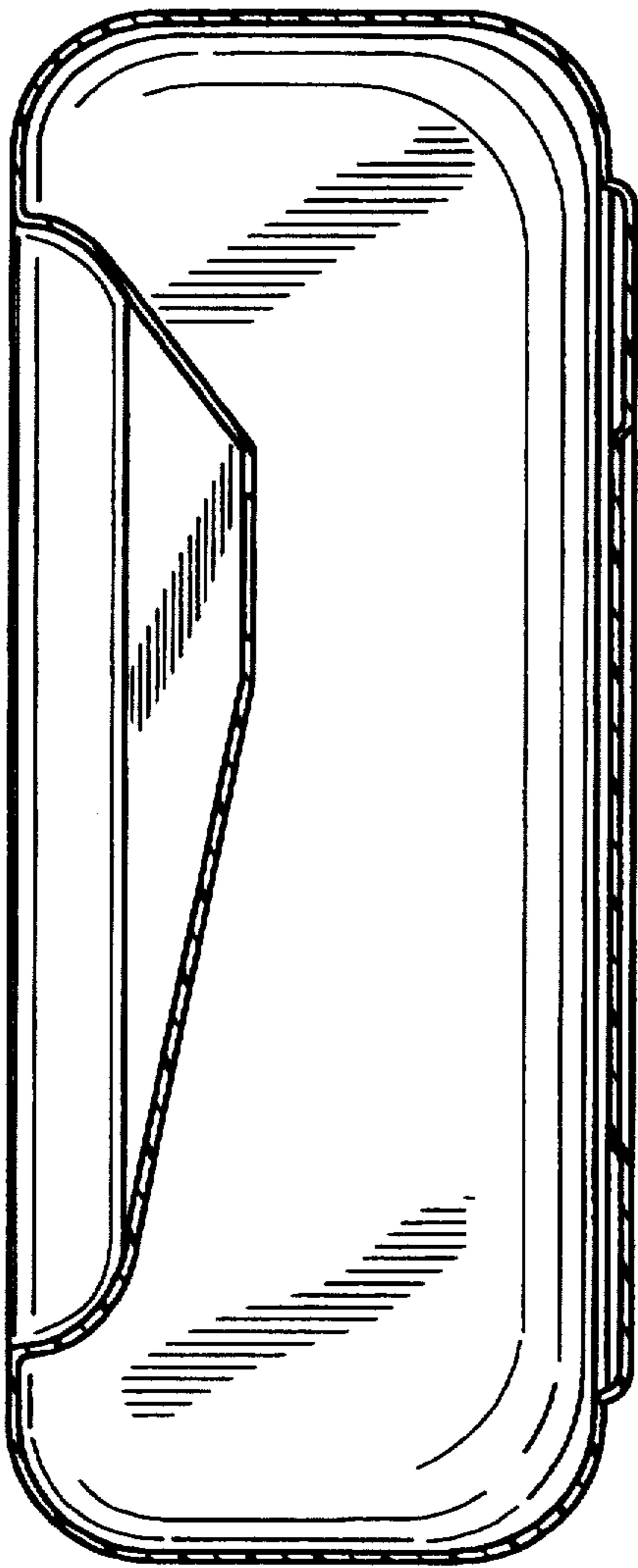

FIG. 9

