



US00D351320S

**United States Patent** [19]  
**Minor**

[11] **Patent Number: Des. 351,320**

[45] **Date of Patent: \*\* Oct. 11, 1994**

[54] **SPORTS COOLER**

[56] **References Cited**

**U.S. PATENT DOCUMENTS**

D. 96,520 8/1935 Thucaky ..... D3/246  
D. 101,792 11/1936 Resnick ..... D3/246

*Primary Examiner*—Terry A. Wallace  
*Attorney, Agent, or Firm*—Hugh E. Smith

[76] **Inventor: Craig S. Minor, 60 Homewood Avenue, Ste. 404, Toronto, Ontario, Canada, M4Y 2X3**

[\*\*] **Term: 14 Years**

[57] **CLAIM**

The ornamental design for a sports cooler, as shown and described.

[21] **Appl. No.: 9,179**

**DESCRIPTION**

FIG. 1 is a front elevational view of the sports cooler showing my new design;

FIG. 2 is a rear elevational view thereof;

FIG. 3 is a left side elevational view thereof;

FIG. 4 is a right side elevational view thereof;

FIG. 5 is a top plan view thereof;

FIG. 6 is a bottom plan view thereof; and,

FIG. 7 is an isometric view thereof.

[22] **Filed: Jun. 7, 1993**

[52] **U.S. Cl. .... D7/606; D3/246**

[58] **Field of Search .... D7/605-608; D3/202, 232, 234, 246, 254; 62/457.1, 457.7, 371.2, 430; 383/109-110, 113; 224/148, 205, 257, 428**

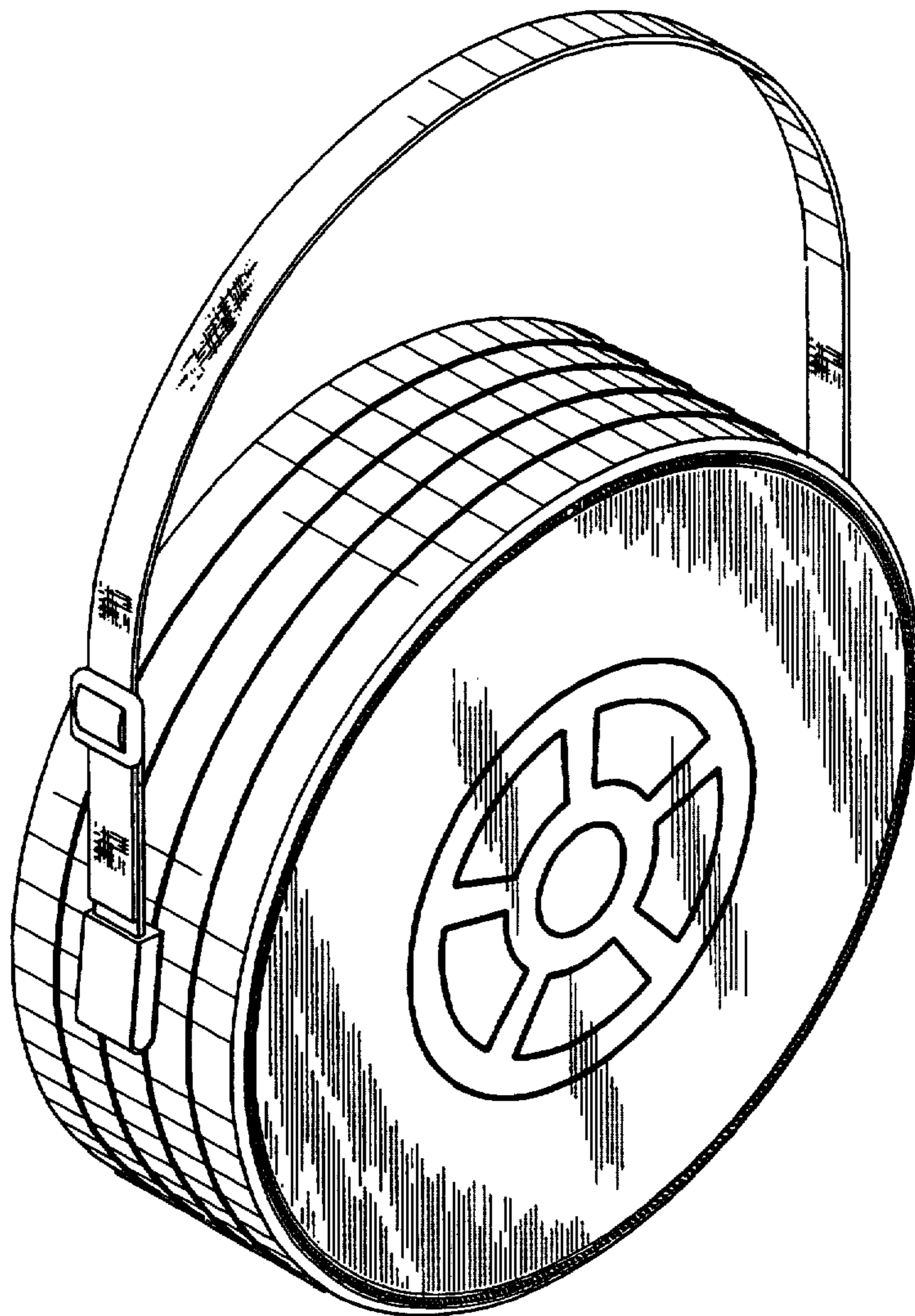

FIG. 1

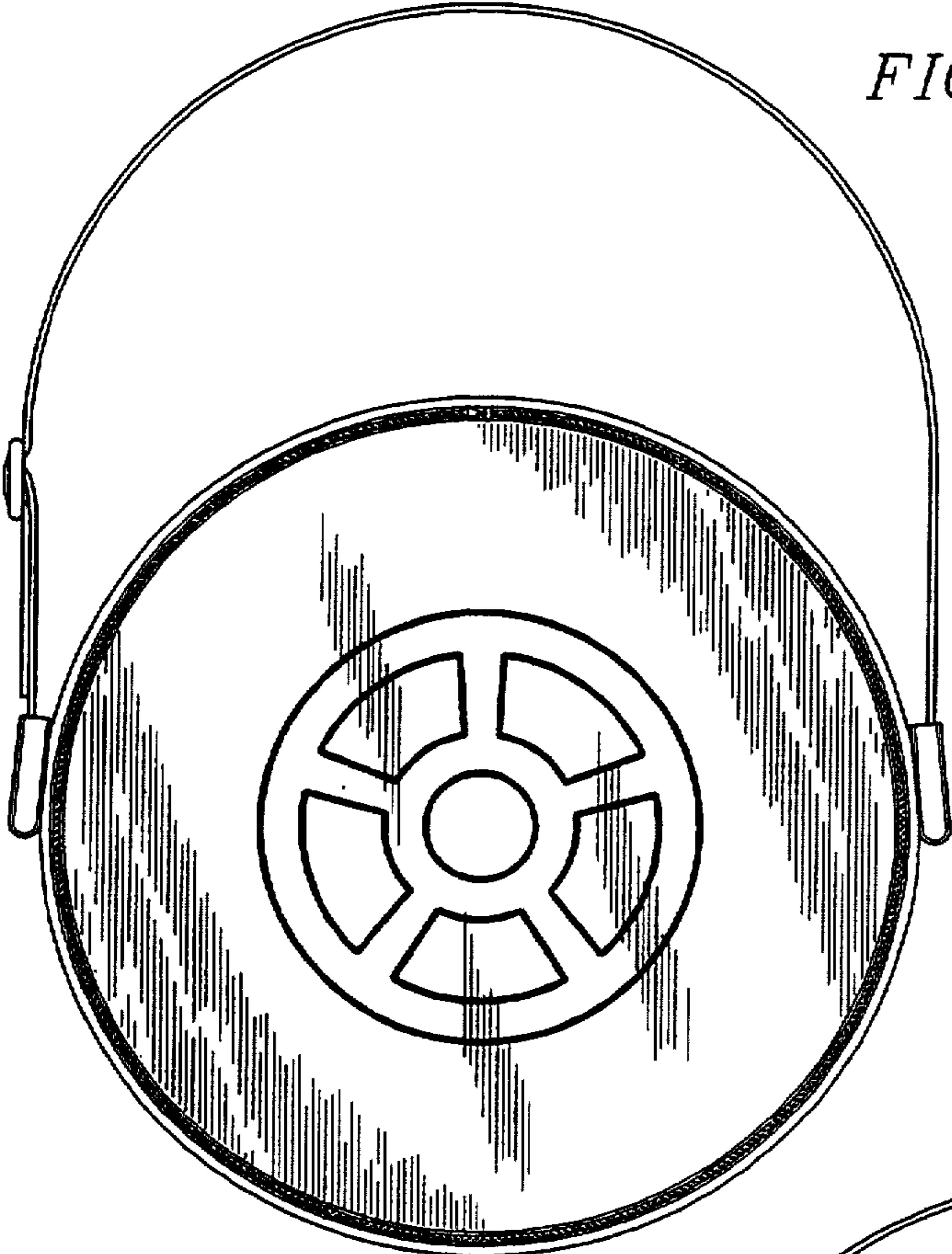

FIG. 2

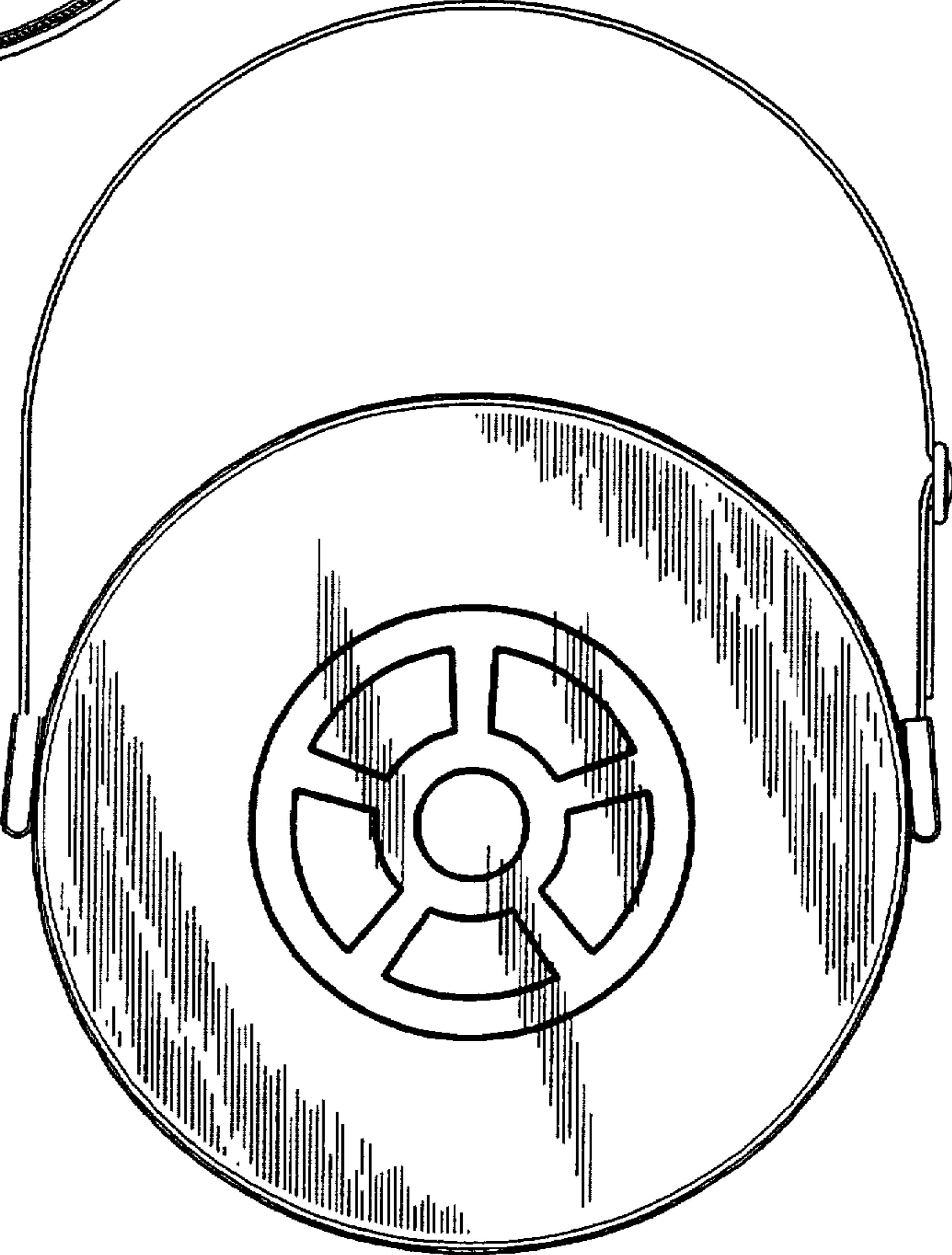

FIG. 3

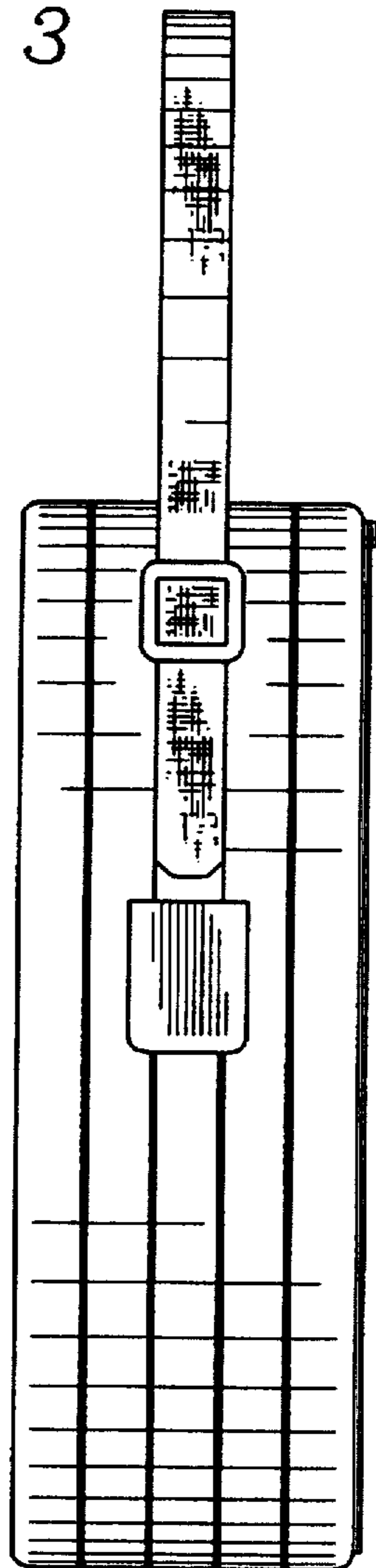

FIG. 4

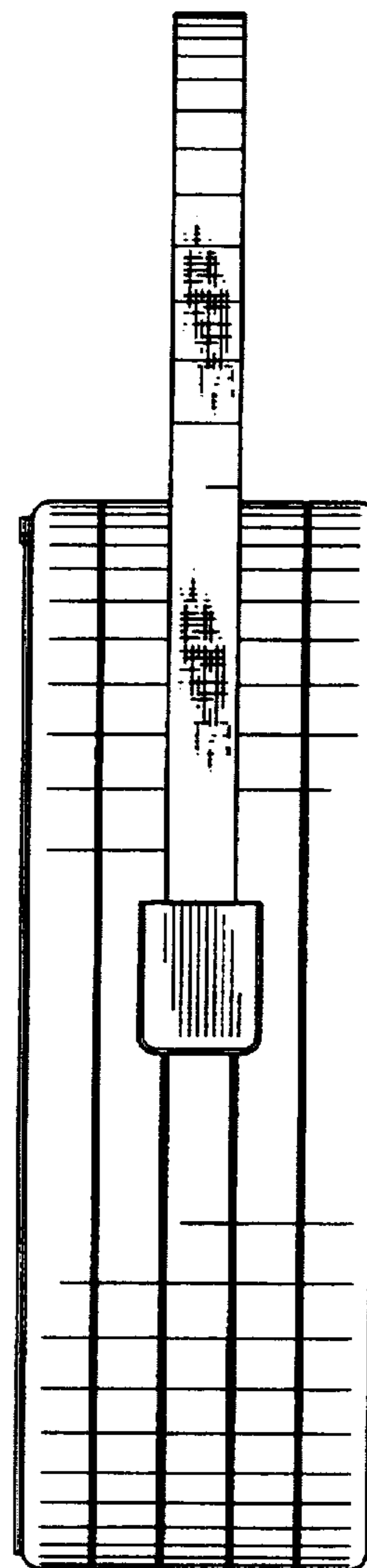

FIG. 5

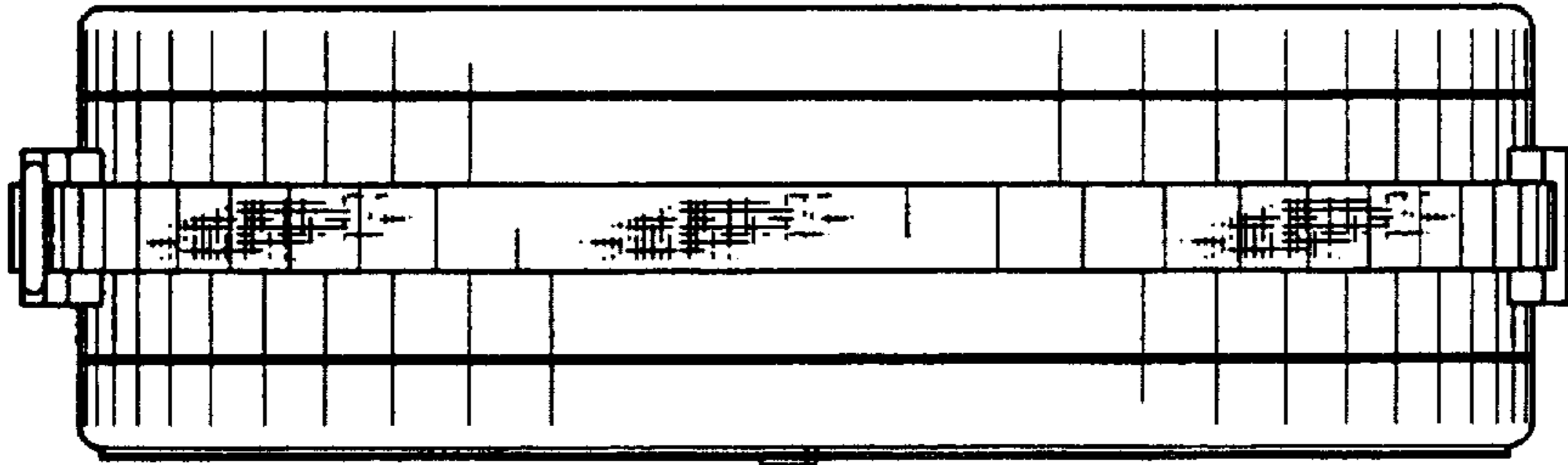

FIG. 6

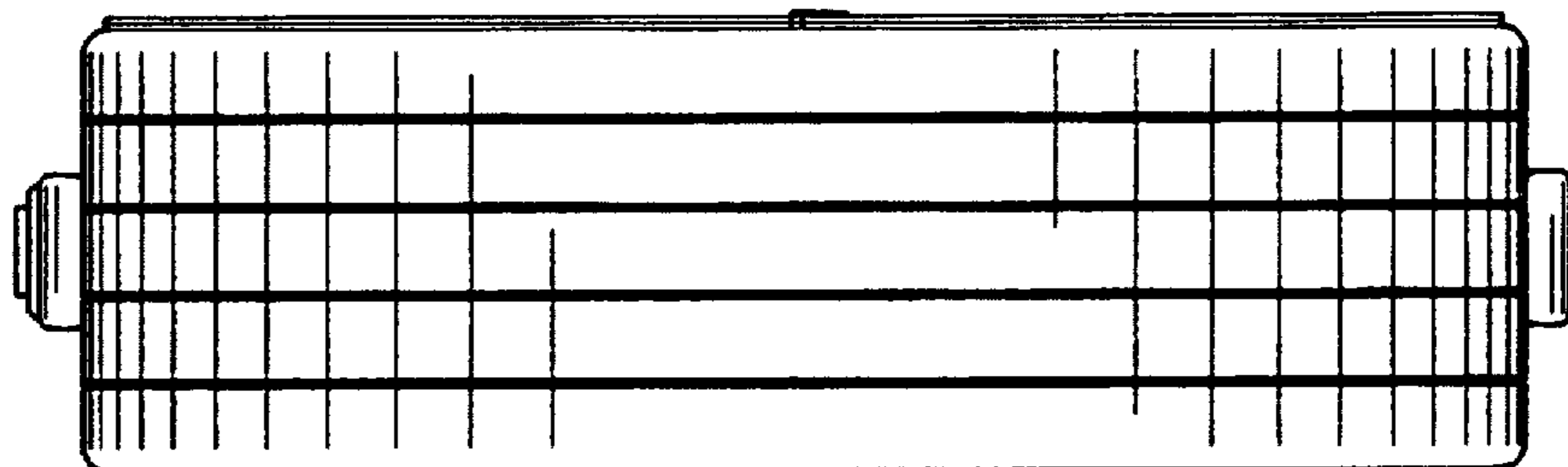

FIG. 7

