



US00D351281S

United States Patent [19] Petryk

[11] Patent Number: **Des. 351,281**
[45] Date of Patent: **** Oct. 11, 1994**

[54] **BELT POUCH**

DESCRIPTION

[76] Inventor: **Michael C. Petryk**, 406 Brudell Road, Saskatoon, Saskatchewan, Canada, S7J 5G4
[**] Term: **14 Years**
[21] Appl. No.: **4,585**
[22] Filed: **Feb. 8, 1993**
[52] U.S. Cl. **D3/230; D3/226; D3/243; D3/245**
[58] Field of Search **D3/226, 203, 243, 215, D3/230, 233, 245, 303; 224/253, 222, 228, 224, 236, 240, 246; 150/152**

FIG. 1 is a front view of a first embodiment of the pouch showing my new design;
FIG. 2 is a left side view thereof;
FIG. 3 is a top view thereof;
FIG. 4 is a bottom view thereof;
FIG. 5 is a back view thereof;
FIG. 6 is a left end view thereof;
FIG. 7 is a front view of the pouch in a fully opened condition;
FIG. 8 is a back view of the pouch in a fully opened condition;
FIG. 9 is a top view of the pouch in a fully opened condition;
FIG. 10 is a bottom view of the pouch in a fully opened condition;
FIG. 11 is a right side view of the pouch in a fully opened condition;
FIG. 12 is a left side view of the pouch in a fully opened condition;
FIG. 13 is a front view of another embodiment of the pouch showing my new design;
FIG. 14 is a left side view of the embodiment of FIG. 13;
FIG. 15 is a top view of the embodiment of FIG. 13;
FIG. 16 is a bottom view of the embodiment of FIG. 13;
FIG. 17 is a back view of the embodiment of FIG. 13;
FIG. 18 is a left side view of the embodiment of FIG. 13;
FIG. 19 is a front view of the embodiment of FIG. 13 in a fully opened condition;
FIG. 20 is a back view of the embodiment of FIG. 13 in a fully opened condition;
FIG. 21 is a top view of the embodiment of FIG. 13 in an opened condition;
FIG. 22 is a bottom view of the embodiment of FIG. 13 in an opened condition;
FIG. 23 is a right side view of the embodiment of FIG. 13 in an opened condition; and
FIG. 24 is a left side elevation of the embodiment of FIG. 13 in an opened condition.

[56] **References Cited**

U.S. PATENT DOCUMENTS

D. 58,316	7/1921	Heald	D3/230
D. 185,944	8/1959	Kehl	D3/230
D. 186,933	12/1959	Sapiro	D3/233 X
D. 266,201	9/1982	Berman	D3/230
D. 286,315	10/1986	Gregory	D3/230 X
D. 325,126	4/1992	Costello	D3/203
597,325	1/1898	Prickett	150/152
790,595	5/1905	Scott	D3/230 X
2,315,095	3/1943	Rhodes	D3/230 X
3,854,639	12/1974	Genchi	224/236 X
4,893,739	1/1990	Conner	224/240

Primary Examiner—A. Hugo Word
Assistant Examiner—Doris V. Coles
Attorney, Agent, or Firm—Murray E. Thrift; Adrian D. Battison; Stanley G. Ade

[57] **CLAIM**
The ornamental design for a belt pouch, as shown and described.

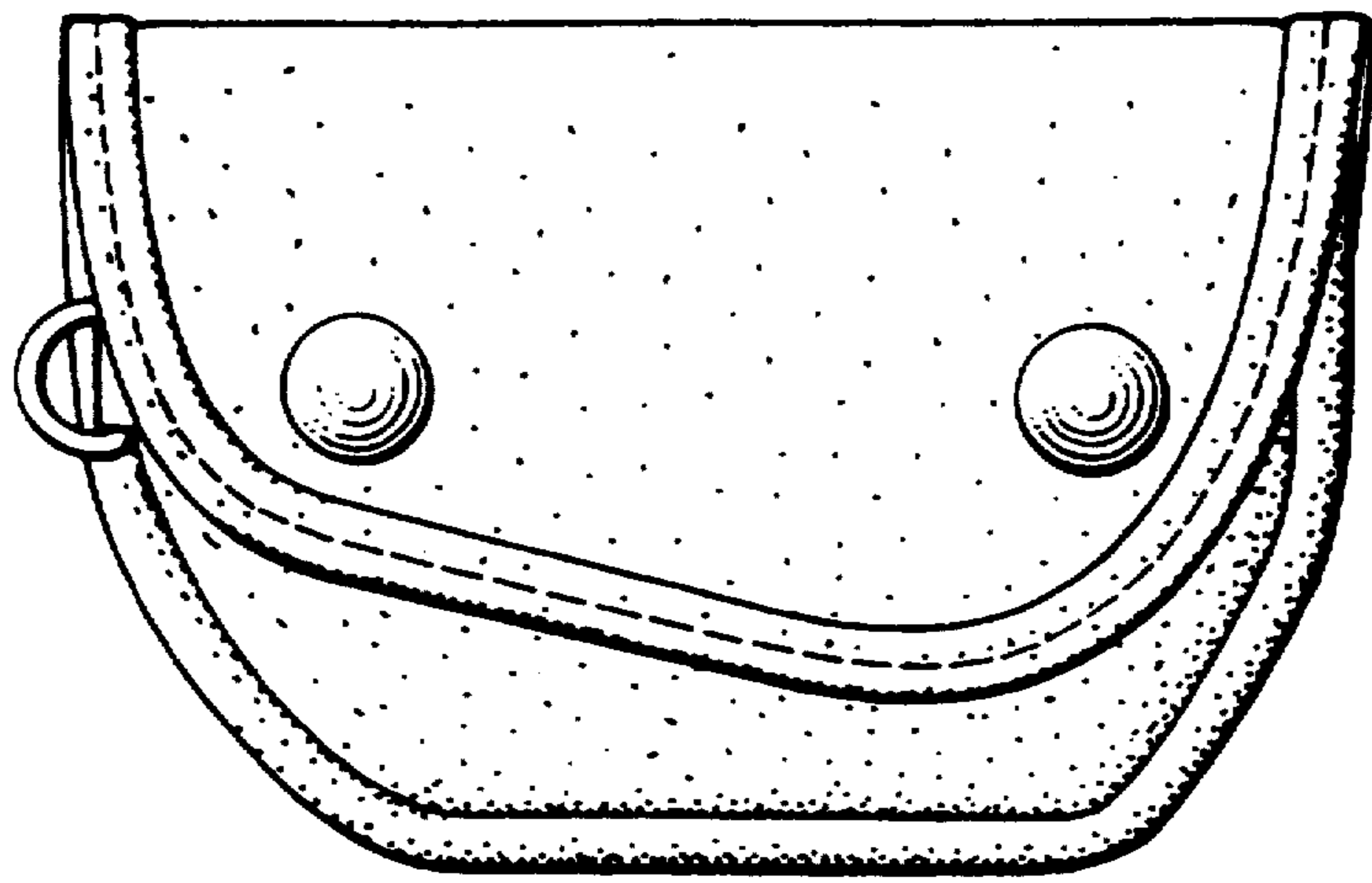

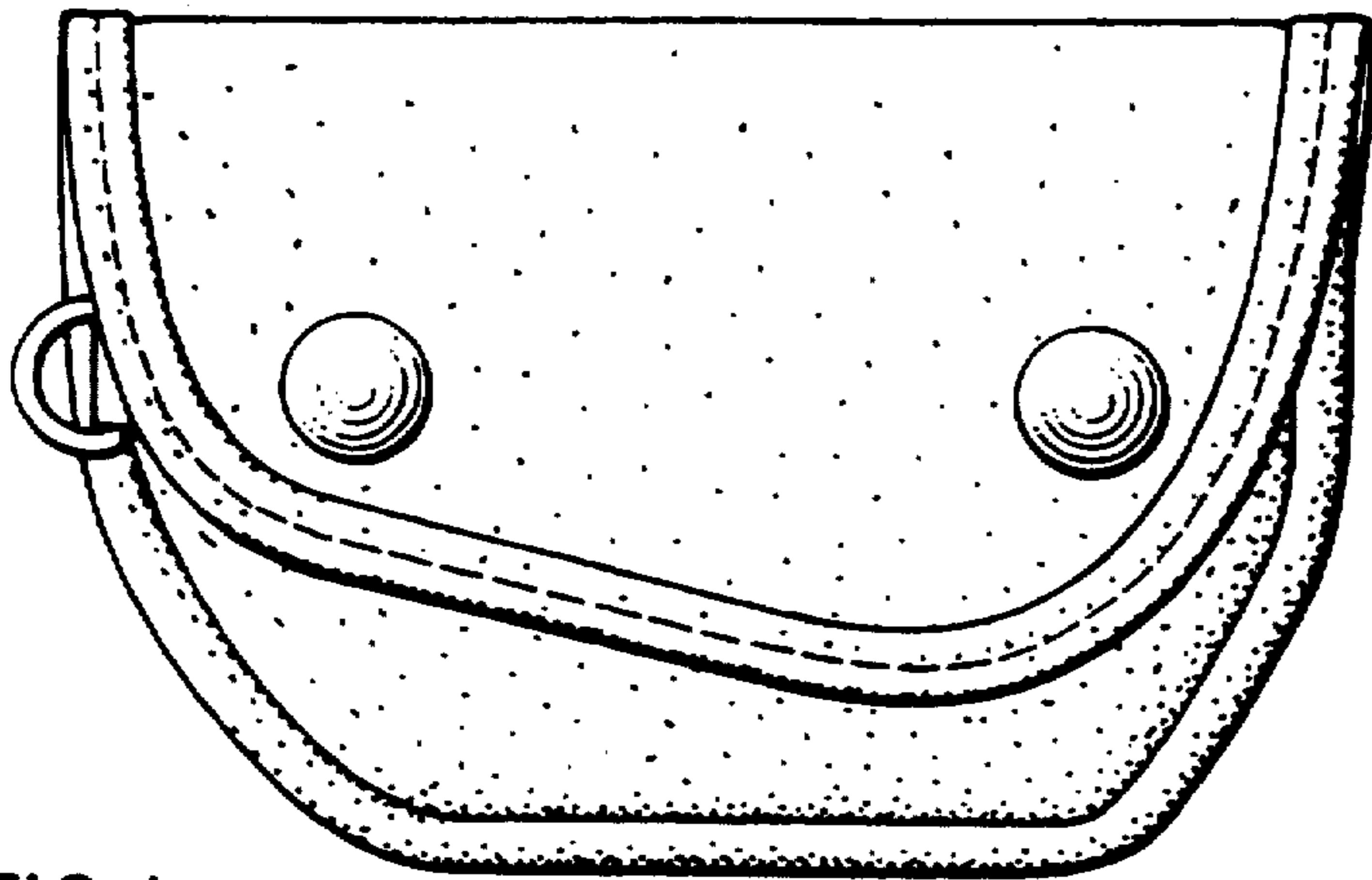

FIG. 1

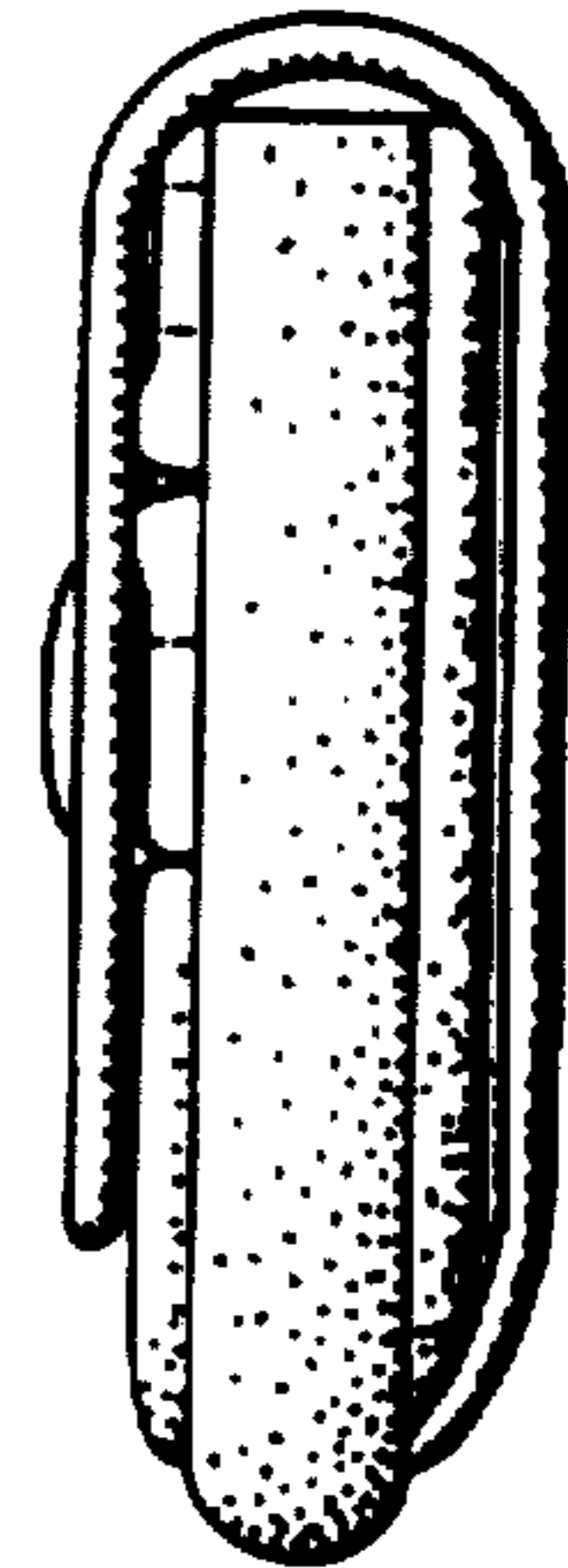

FIG. 2



FIG. 3



FIG. 4

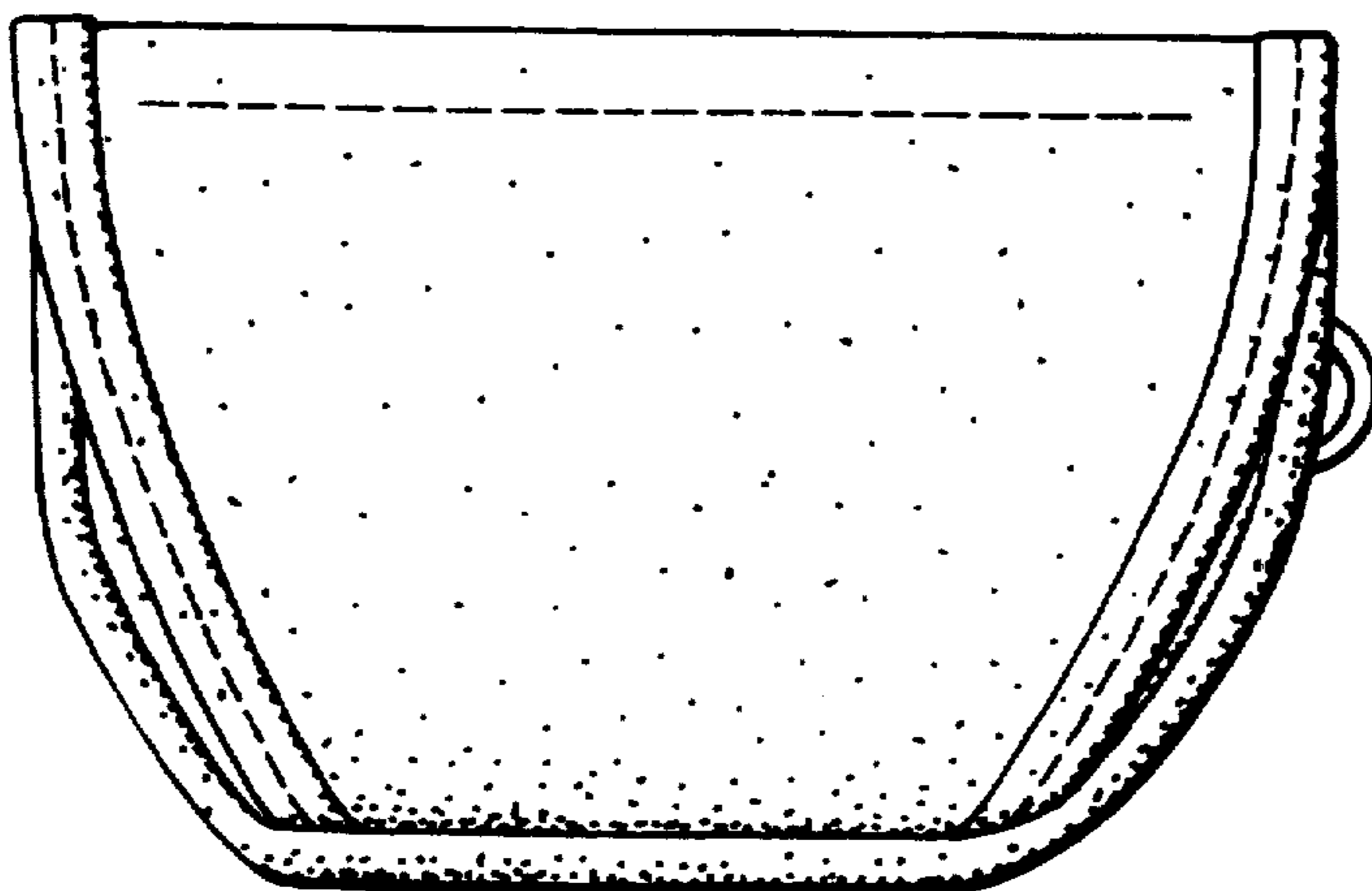

FIG. 5



FIG. 6

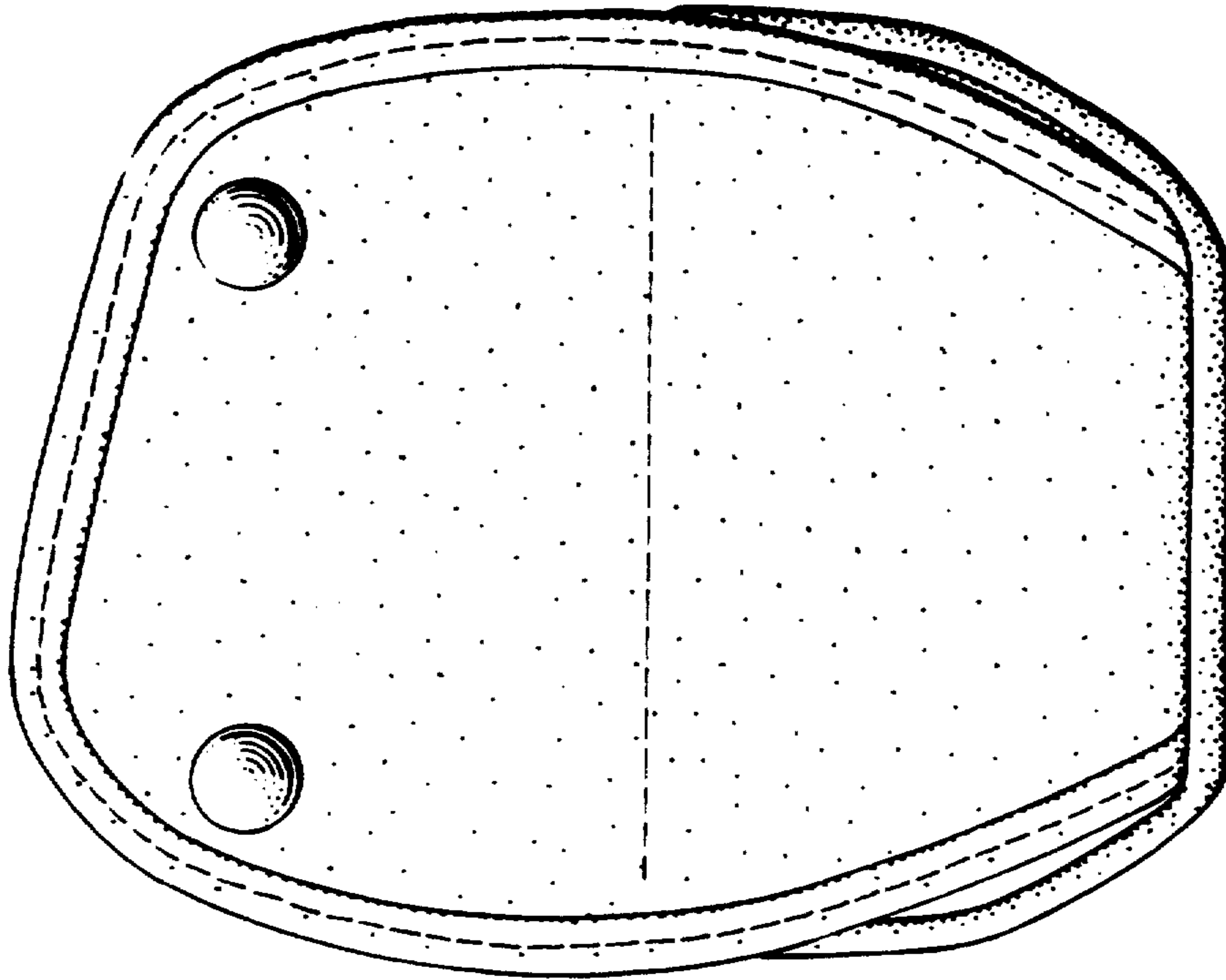

FIG. 8

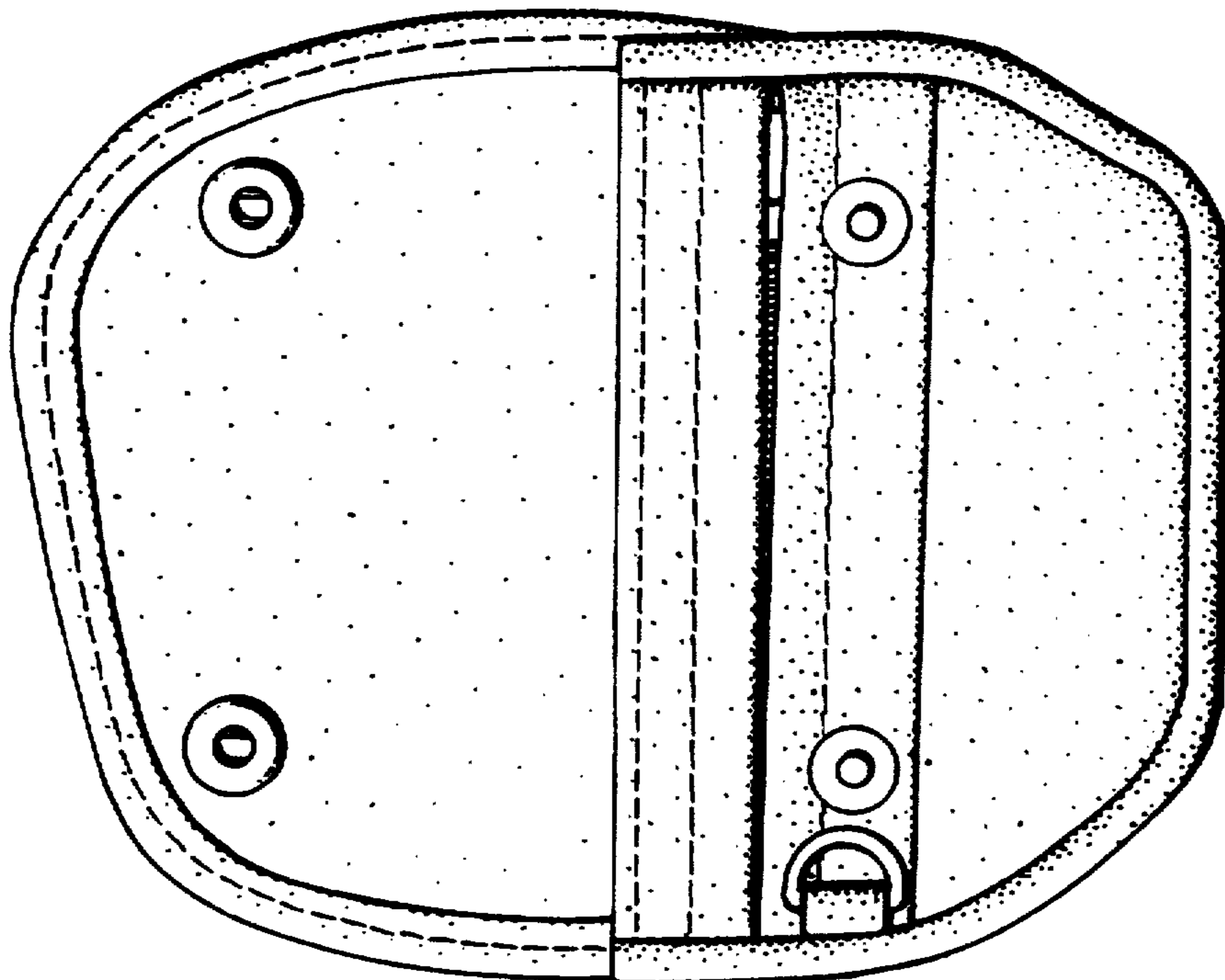

FIG. 7

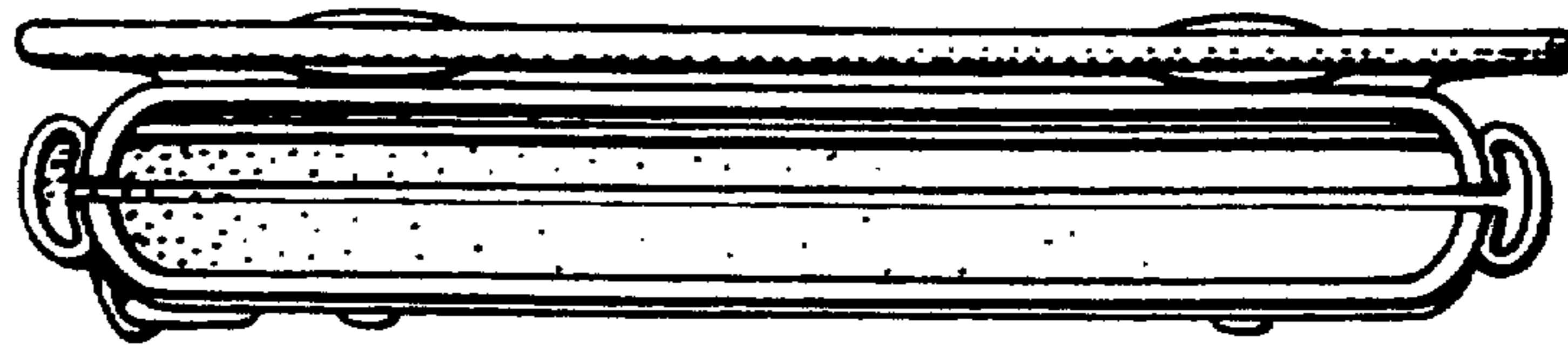

FIG. 9

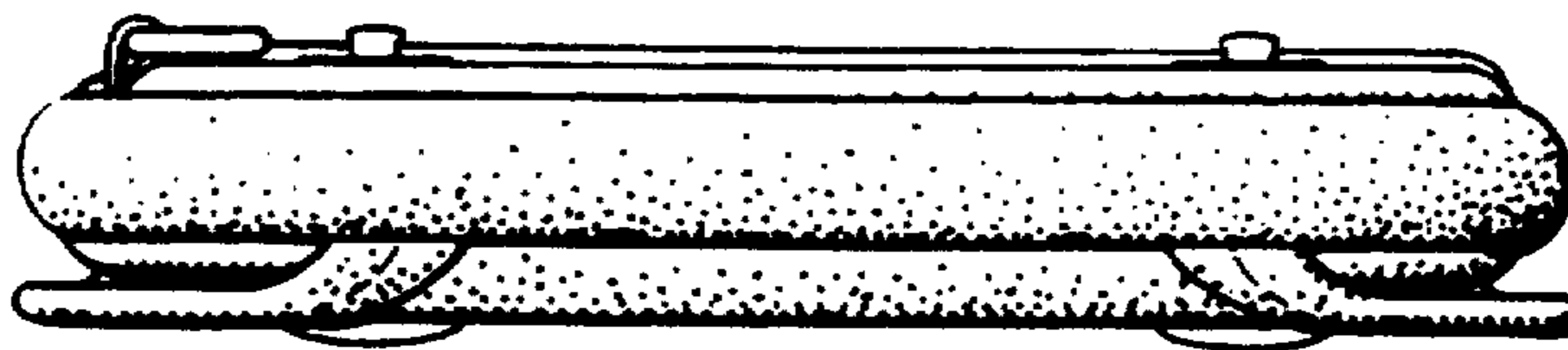

FIG. 10

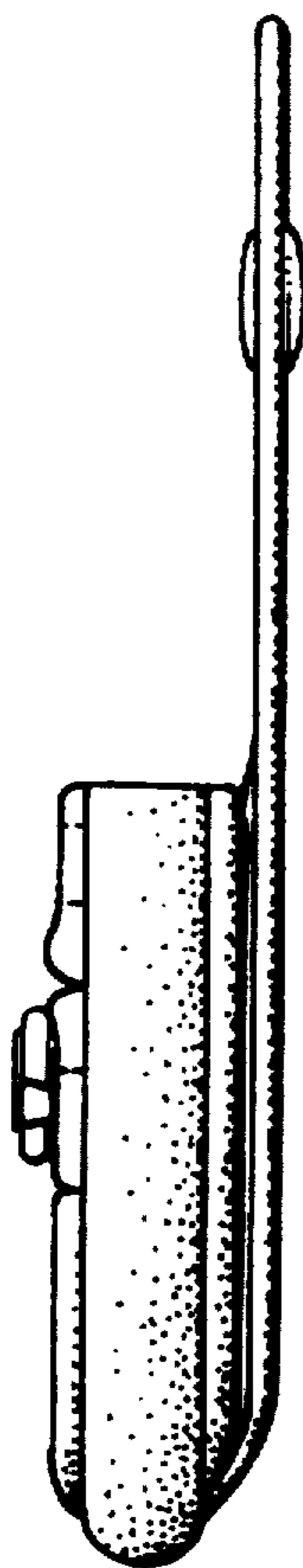

FIG. 11

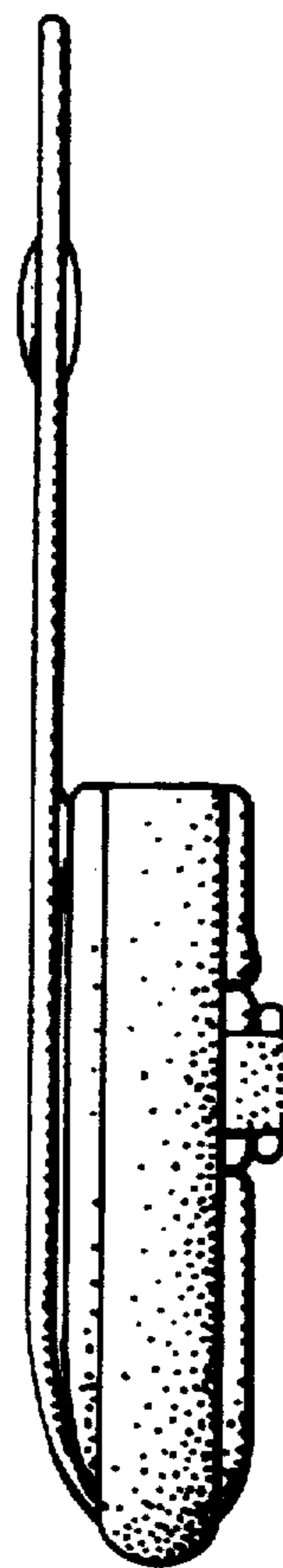

FIG. 12

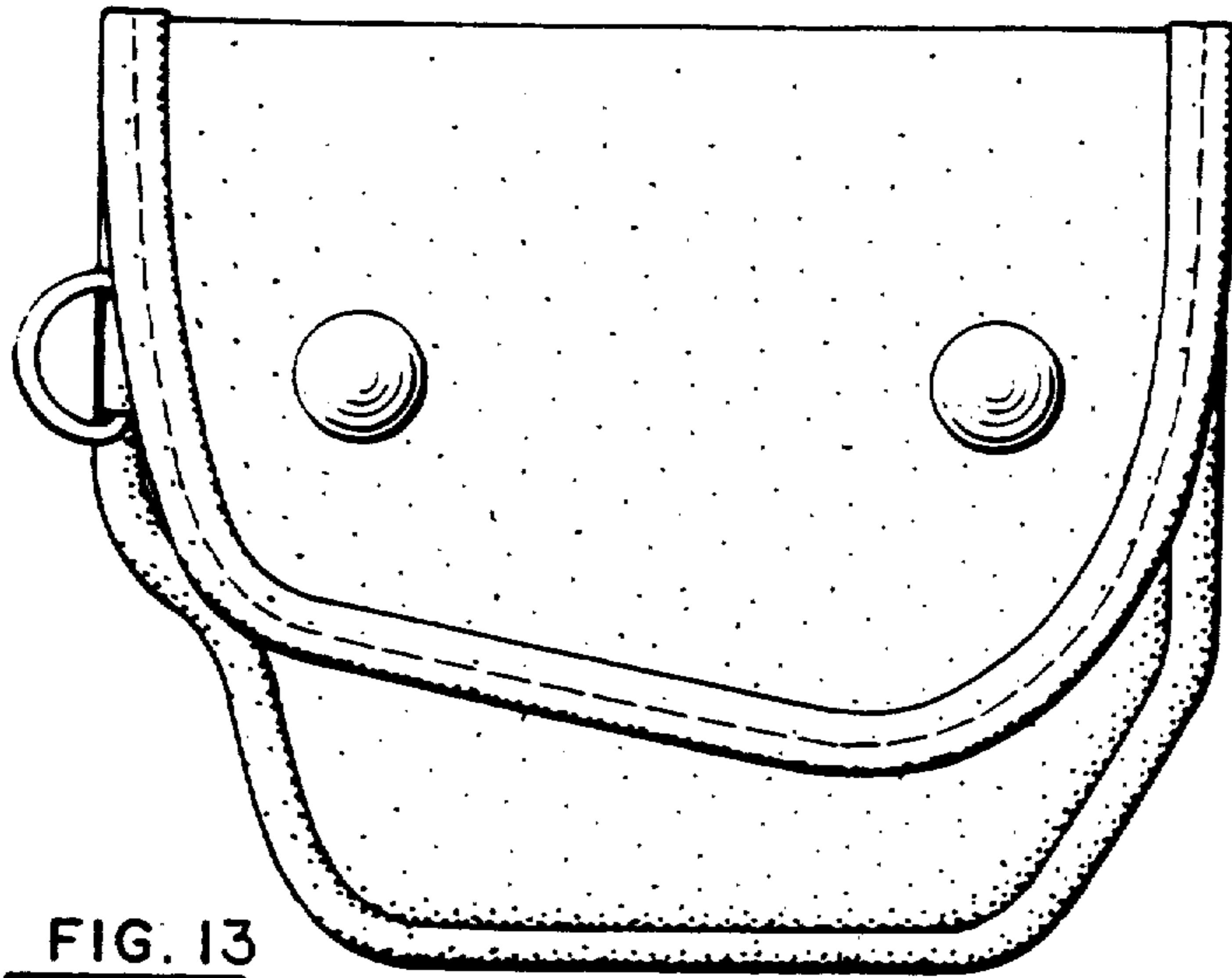

FIG. 13

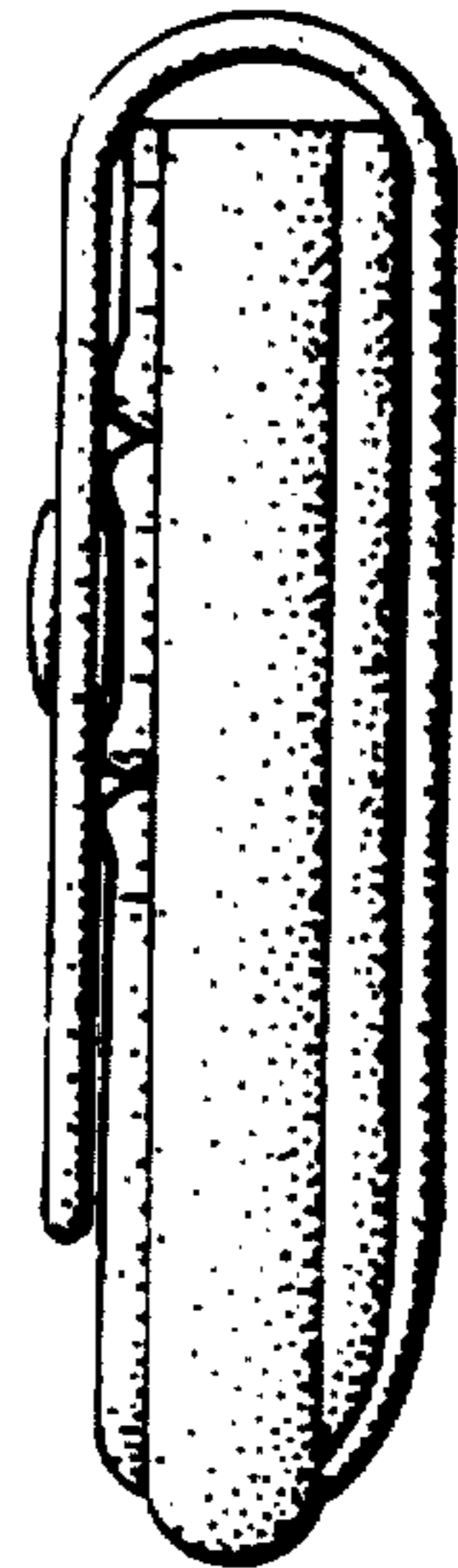

FIG. 14



FIG. 15



FIG. 16

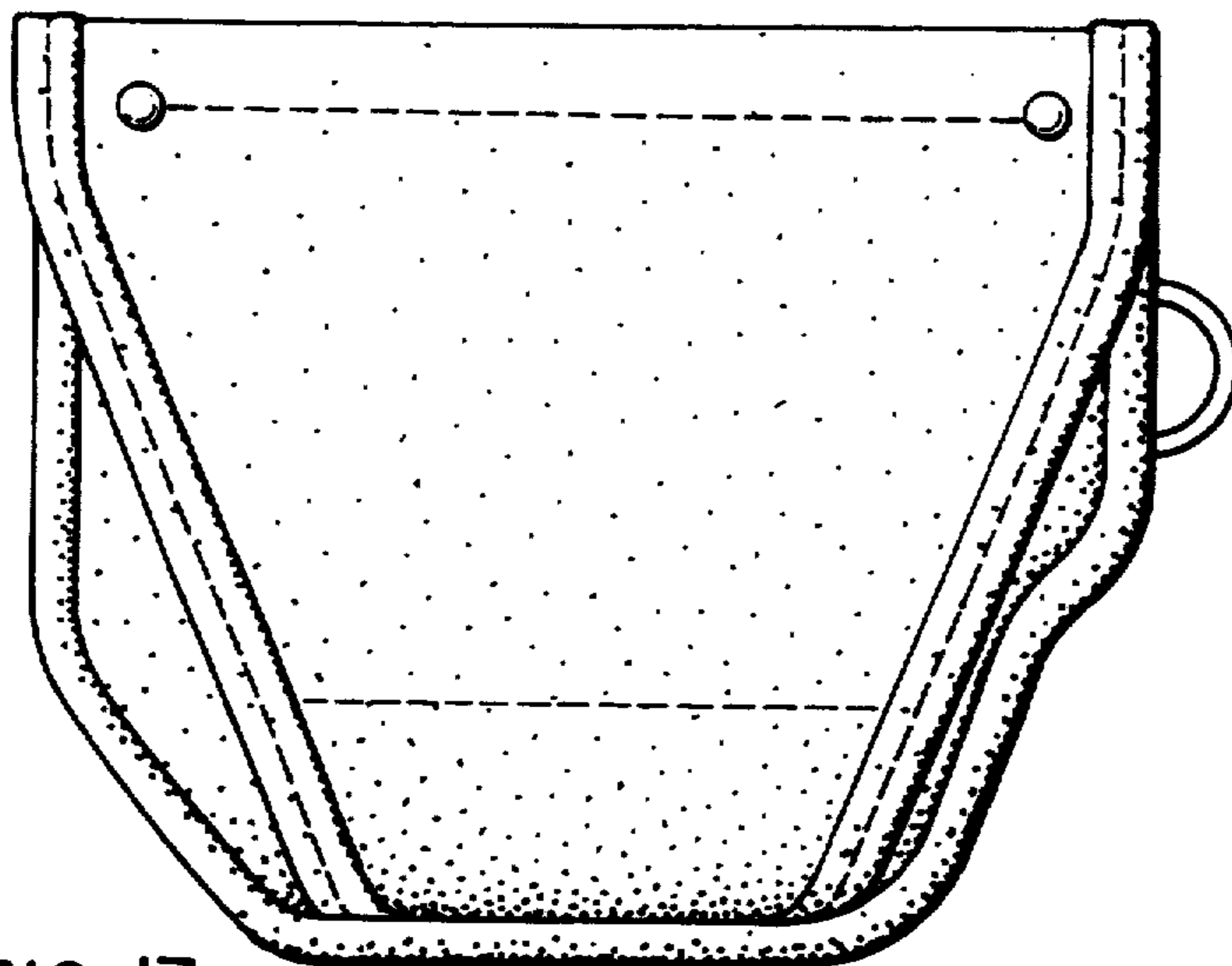

FIG. 17



FIG. 18

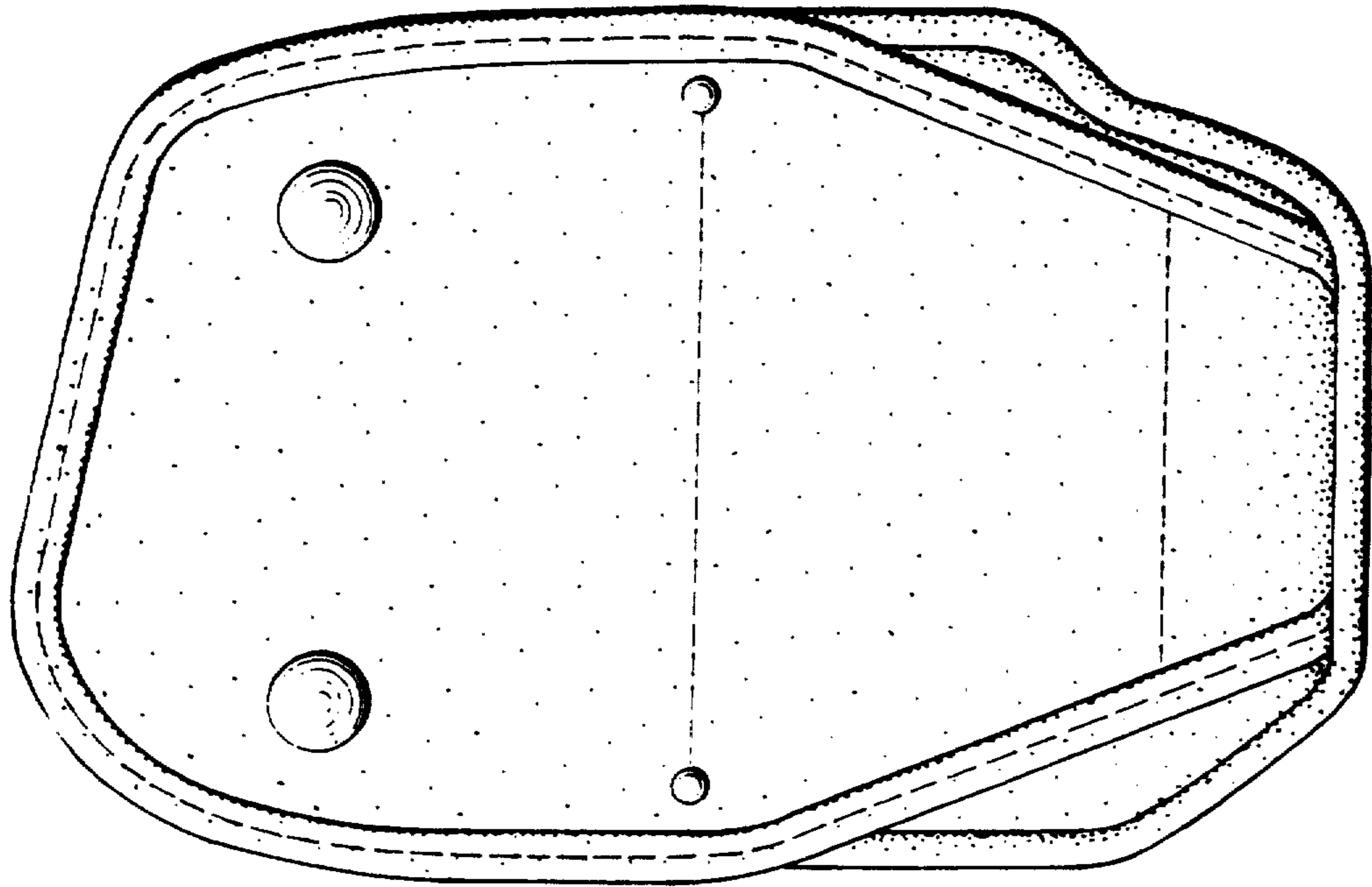

FIG. 20

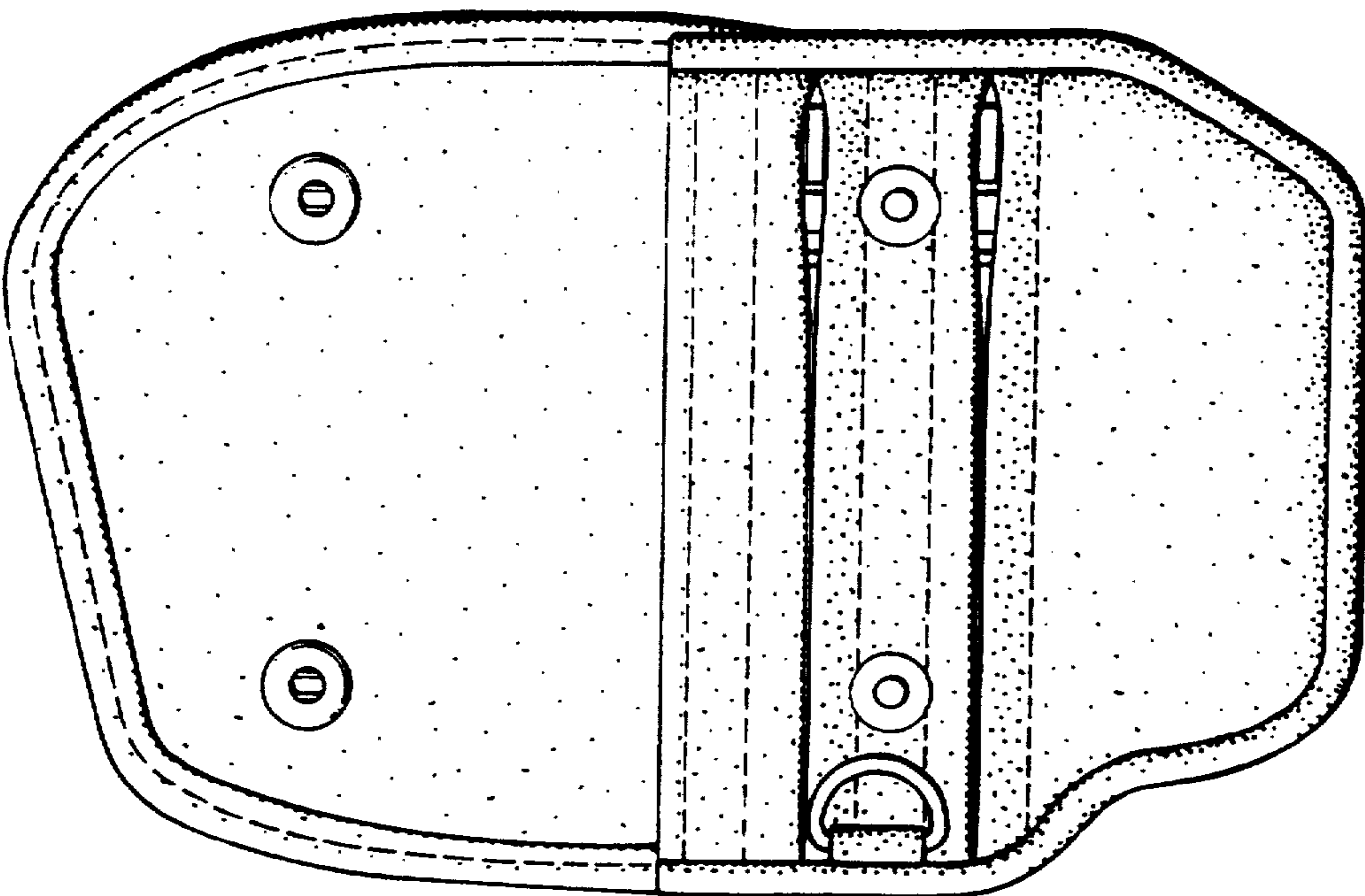

FIG. 19

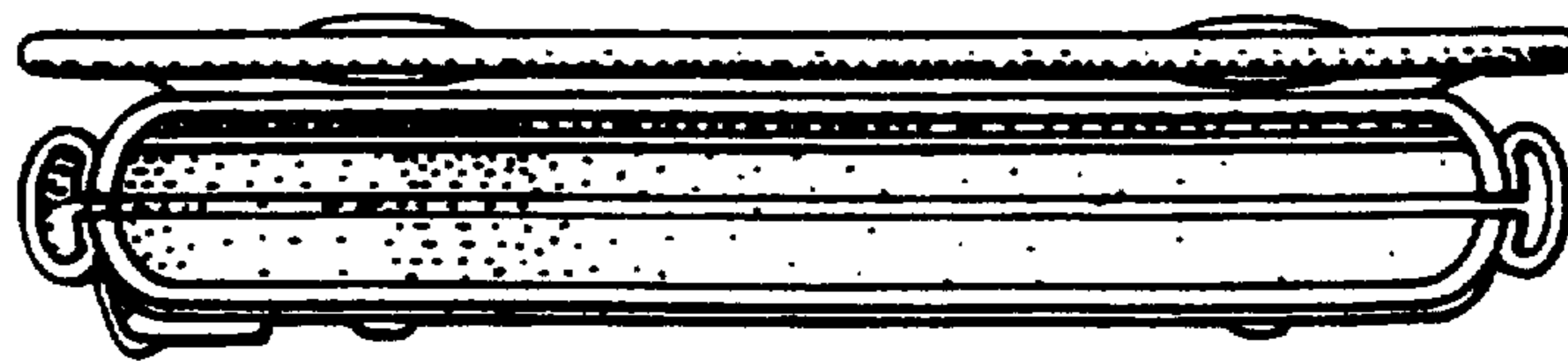

FIG. 21

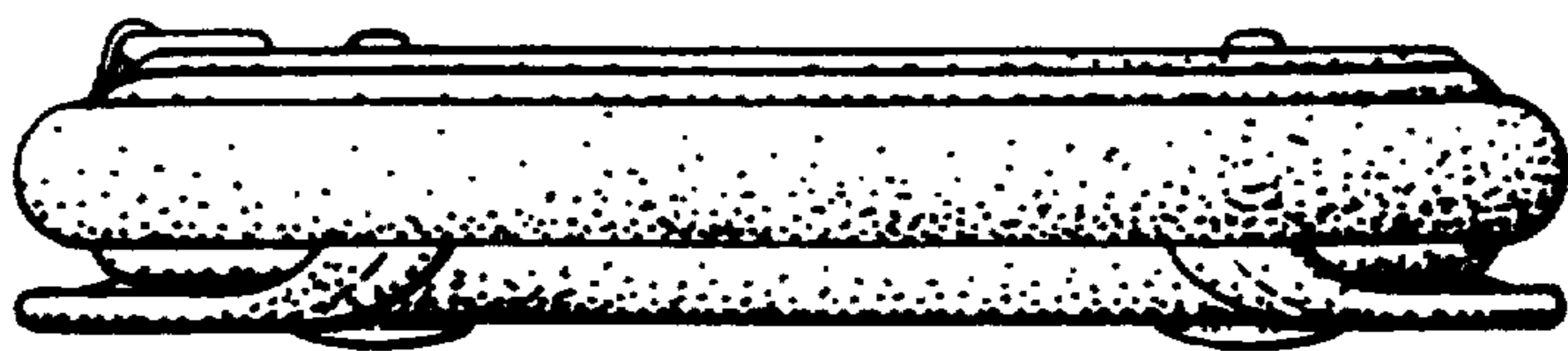

FIG. 22

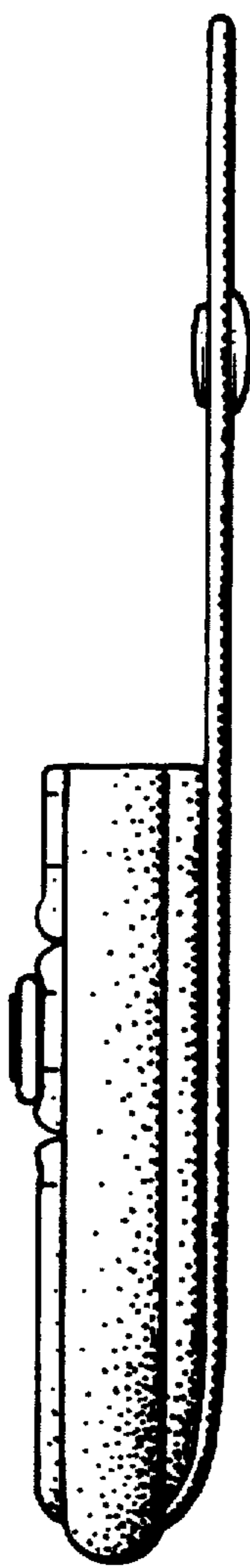

FIG. 23

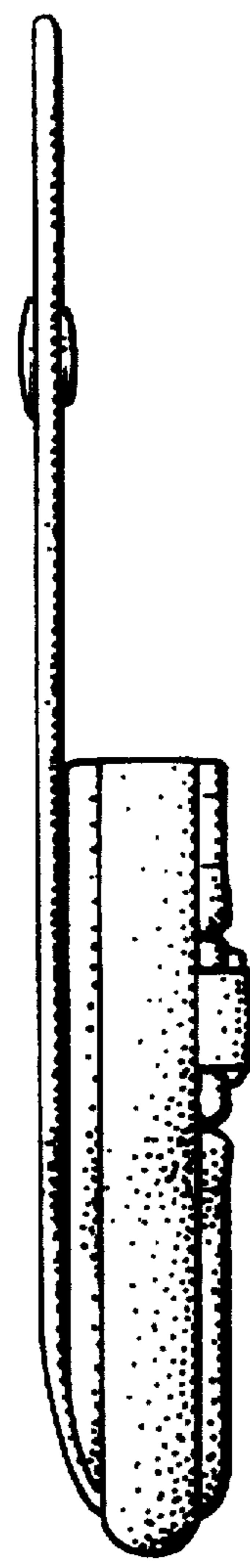

FIG. 24