



US00D351276S

**United States Patent** [19]  
**Gitelman**

[11] **Patent Number: Des. 351,276**

[45] **Date of Patent: \*\* Oct. 11, 1994**

[54] **STRAP MEMBER FOR SHOE UPPER**

[75] **Inventor: Lyuba Gitelman, Hamden, Conn.**

[73] **Assignee: Fila U.S.A. Inc., Hunter Valley, Md.**

[\*\*] **Term: 14 Years**

[21] **Appl. No.: 8,079**

[22] **Filed: May 10, 1993**

[52] **U.S. Cl. .... D2/973**

[58] **Field of Search .... D2/896, 898, 916-918, D2/946, 969, 970, 973; 36/45, 50.1, 11.5, 83, 84, 89, 102-107, 112-114, 132, 136**

[56] **References Cited**

**U.S. PATENT DOCUMENTS**

- D. 110,362 7/1938 Oliphant ..... D2/898
- D. 294,654 3/1988 Liggett et al. .... D2/970
- D. 295,230 4/1988 Tong ..... D2/970
- D. 297,781 9/1988 Diaz et al. .... D2/973

- D. 299,184 1/1989 McCrea ..... D2/973
- D. 336,358 6/1993 Hatfield ..... D2/973

*Primary Examiner*—Louis S. Zarfes  
*Attorney, Agent, or Firm*—Martin Smolowitz

[57] **CLAIM**

The ornamental design of a strap member for shoe upper, as shown and described.

**DESCRIPTION**

FIG. 1 is a top, front and right side perspective view of the strap member for shoe upper showing my new design, with a shoe shown in phantom lines for environmental purposes only;

FIG. 2 is a top plan view thereof;

FIG. 3 is a left side view thereof;

FIG. 4 is a front view thereof;

FIG. 5 is a right side view thereof;

FIG. 6 is a rear view thereof; and,

FIG. 7 is a bottom plan view thereof.

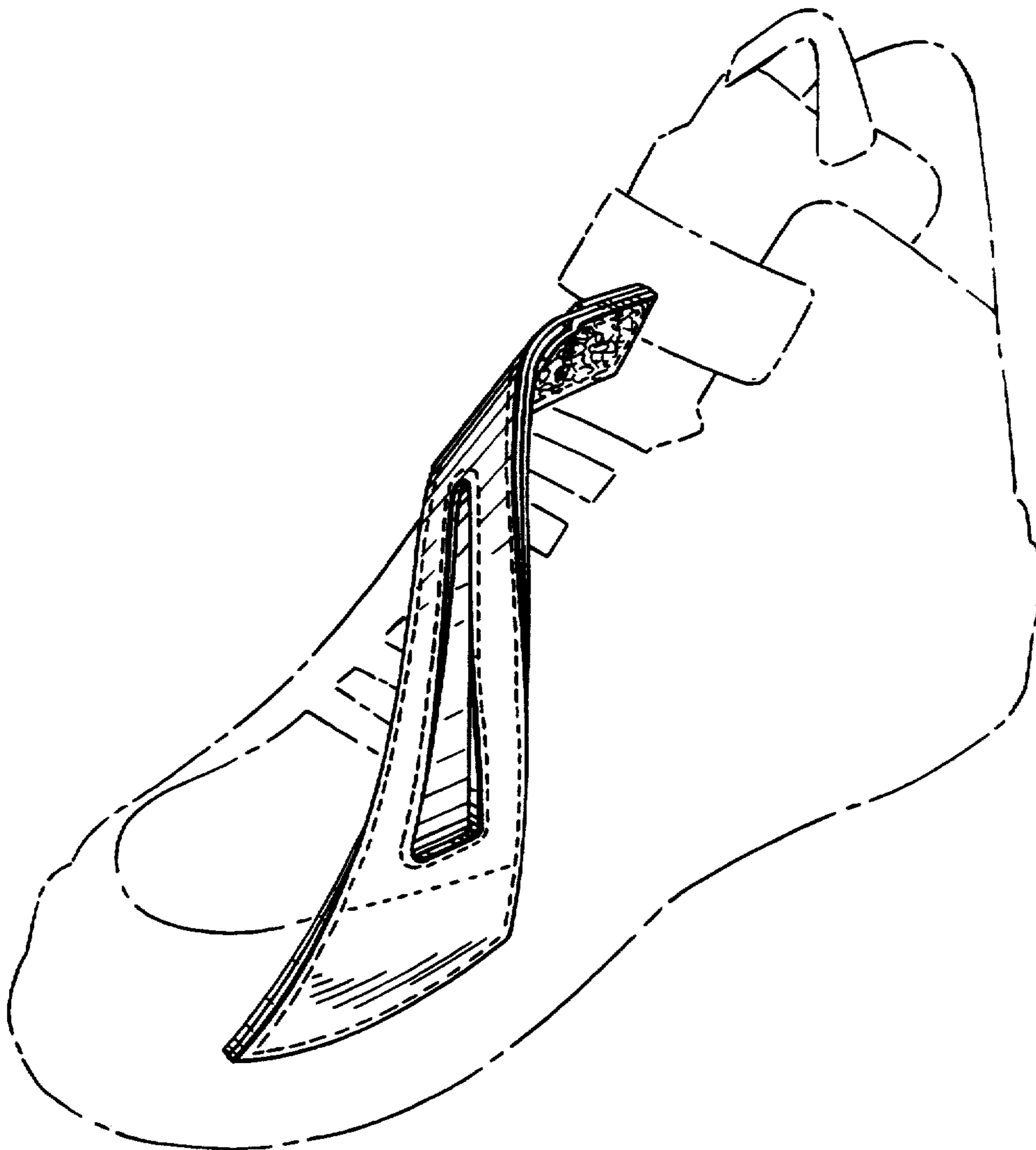

*FIG. 1*

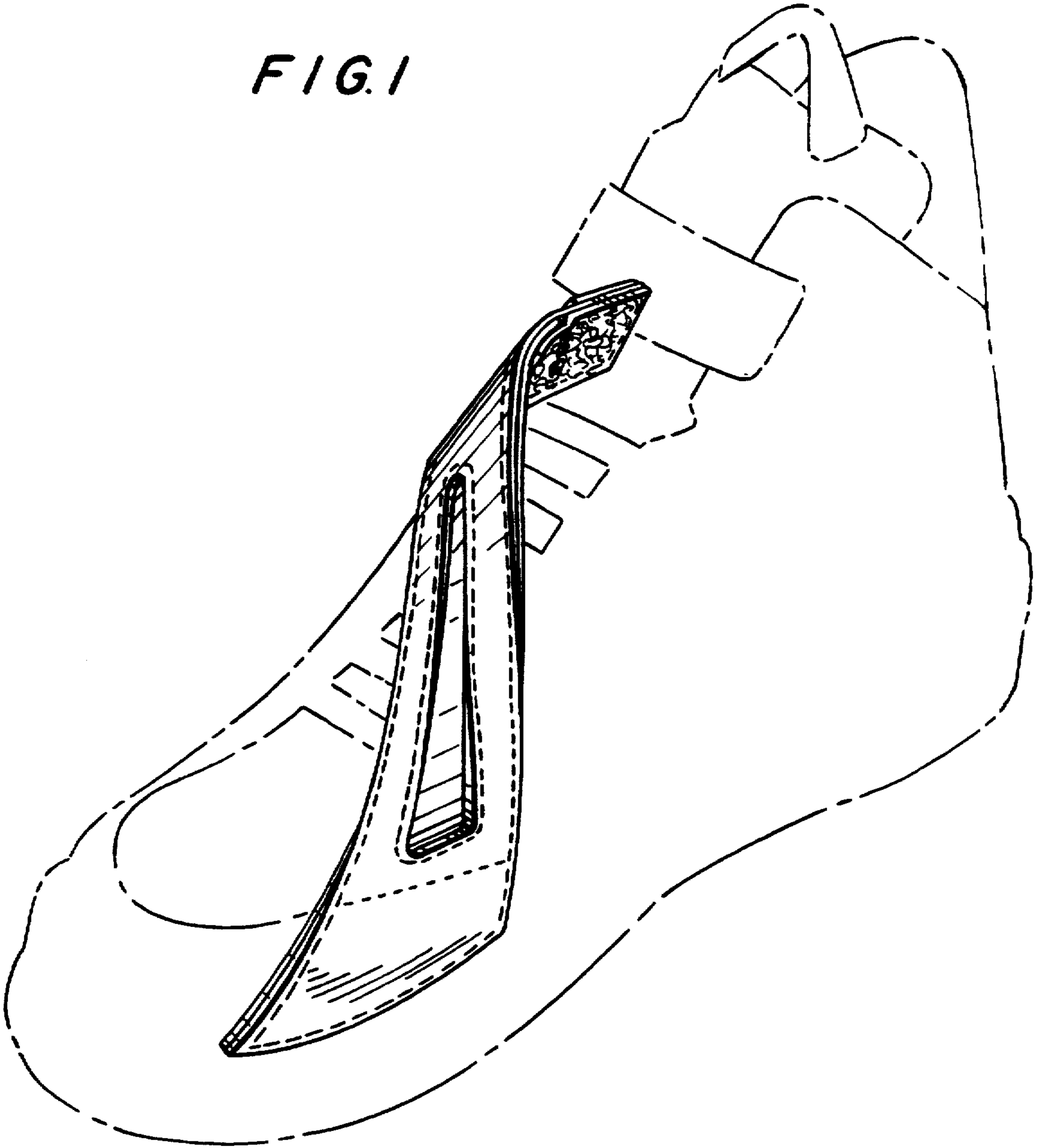

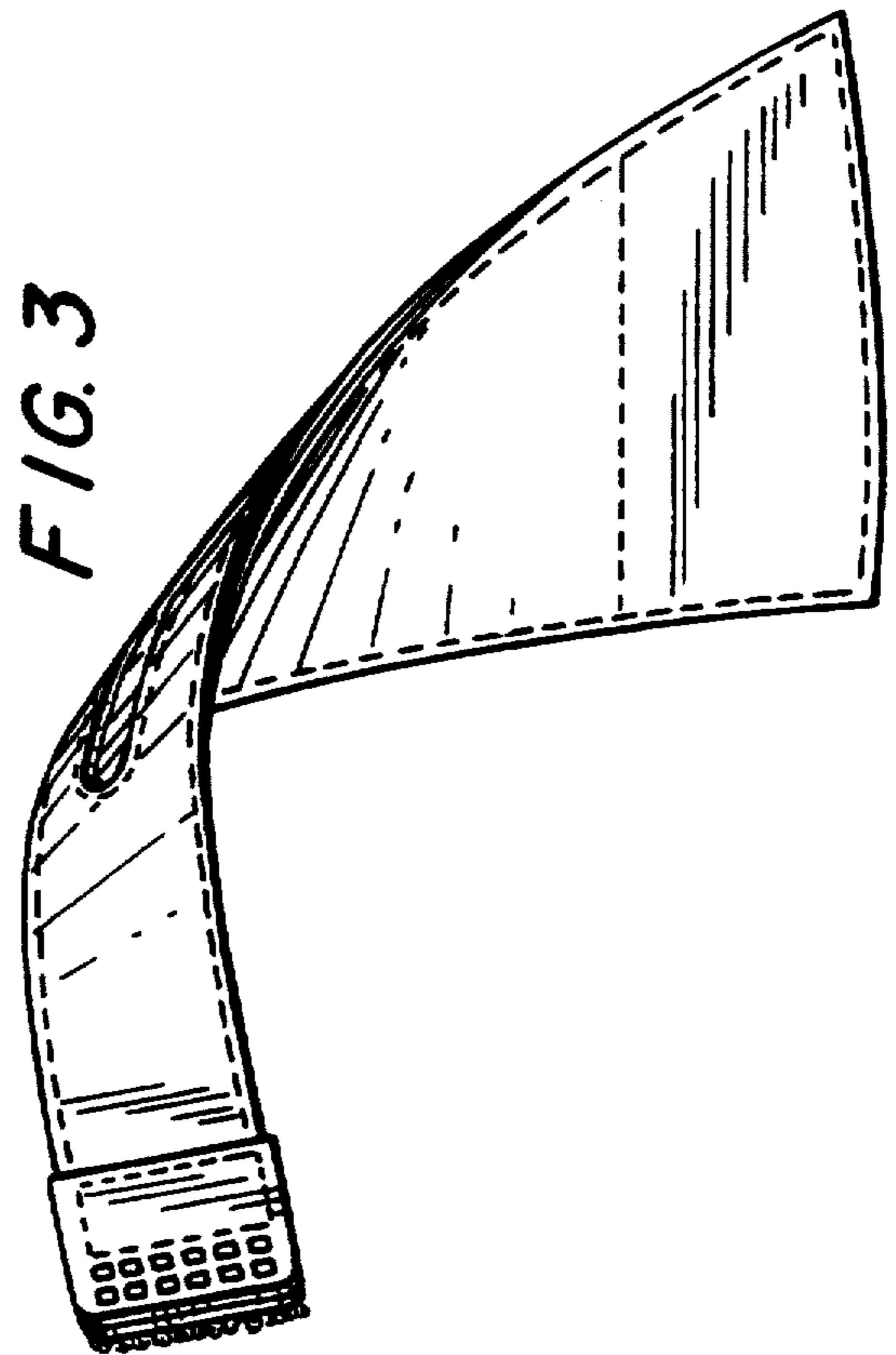
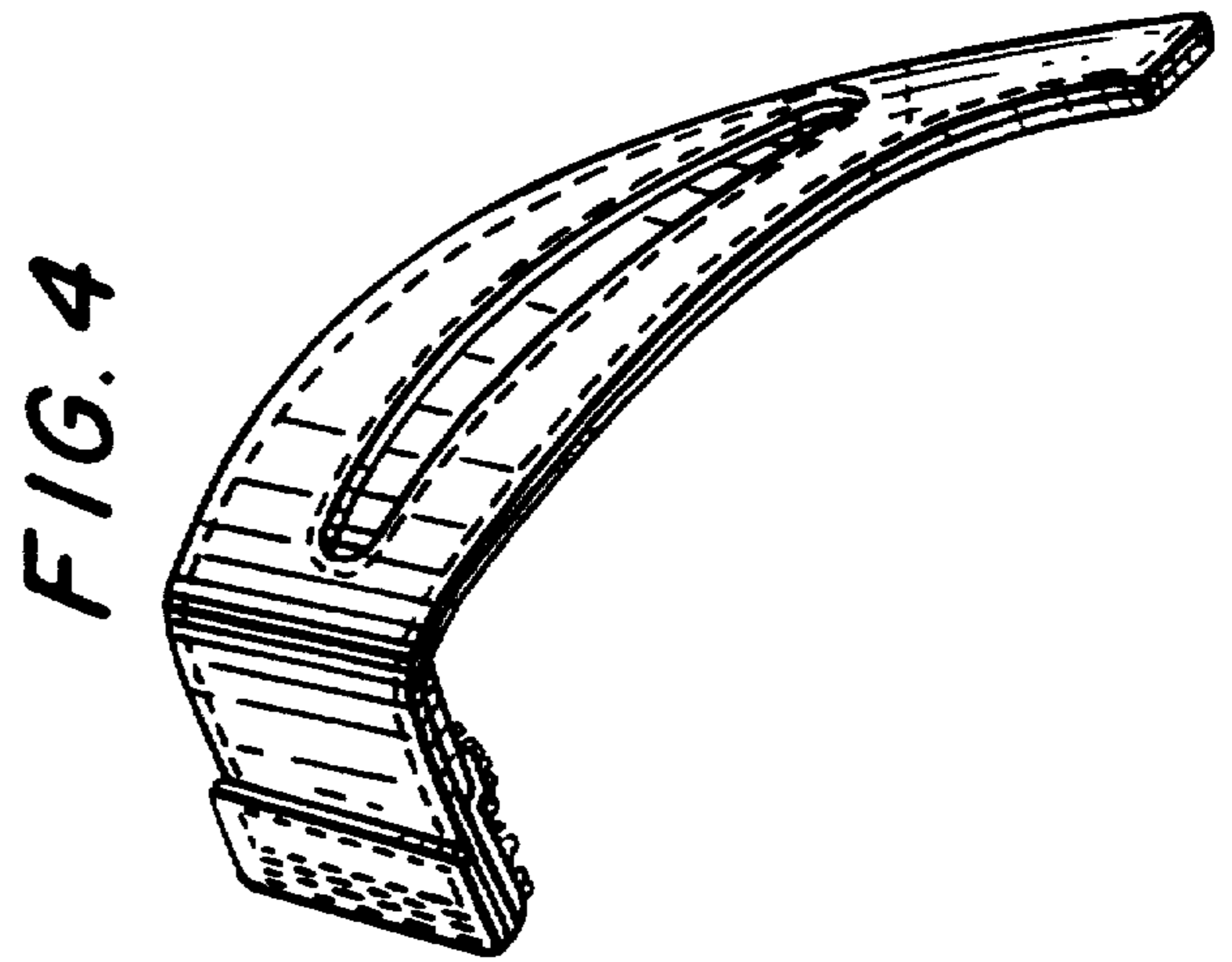
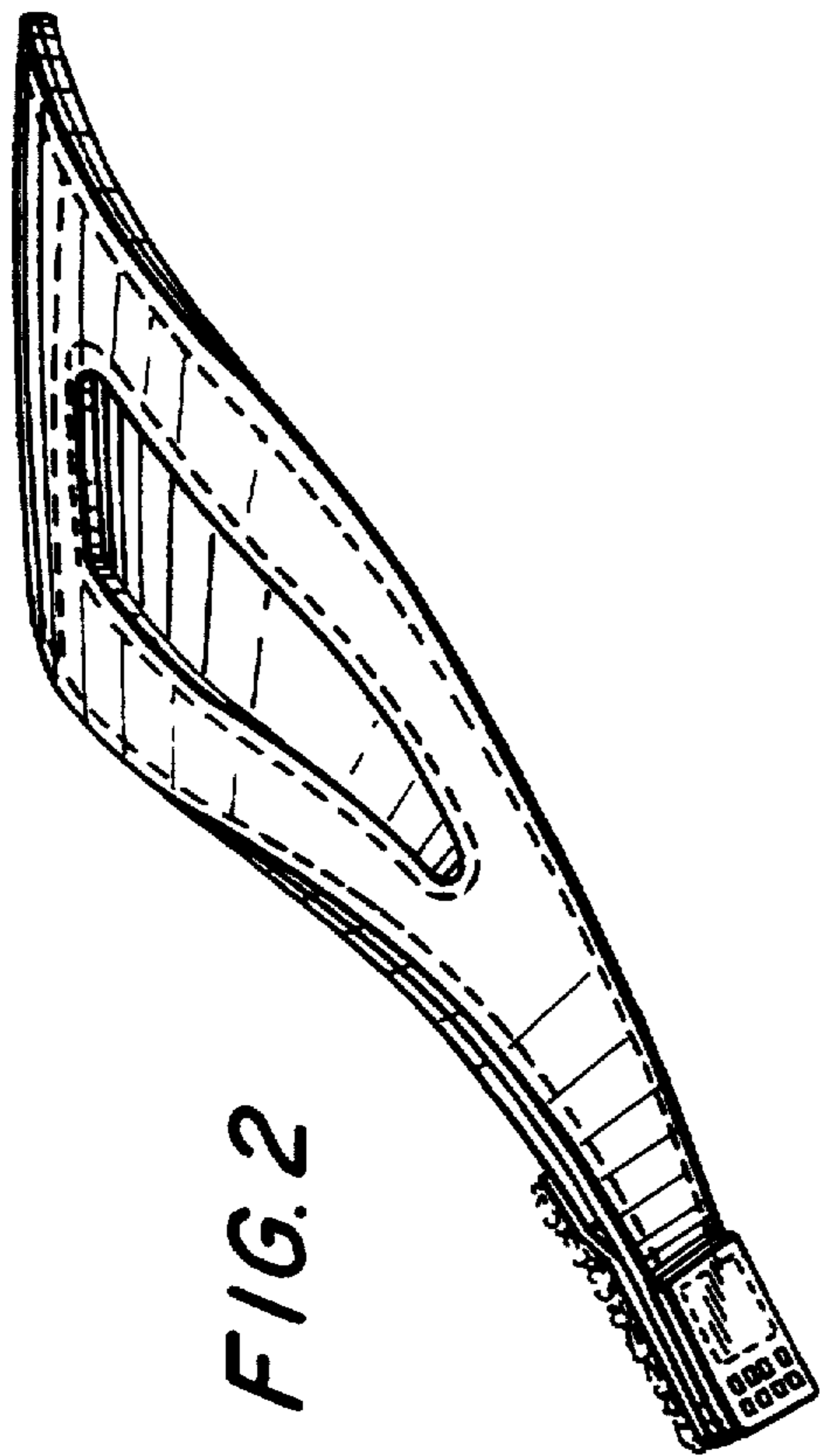

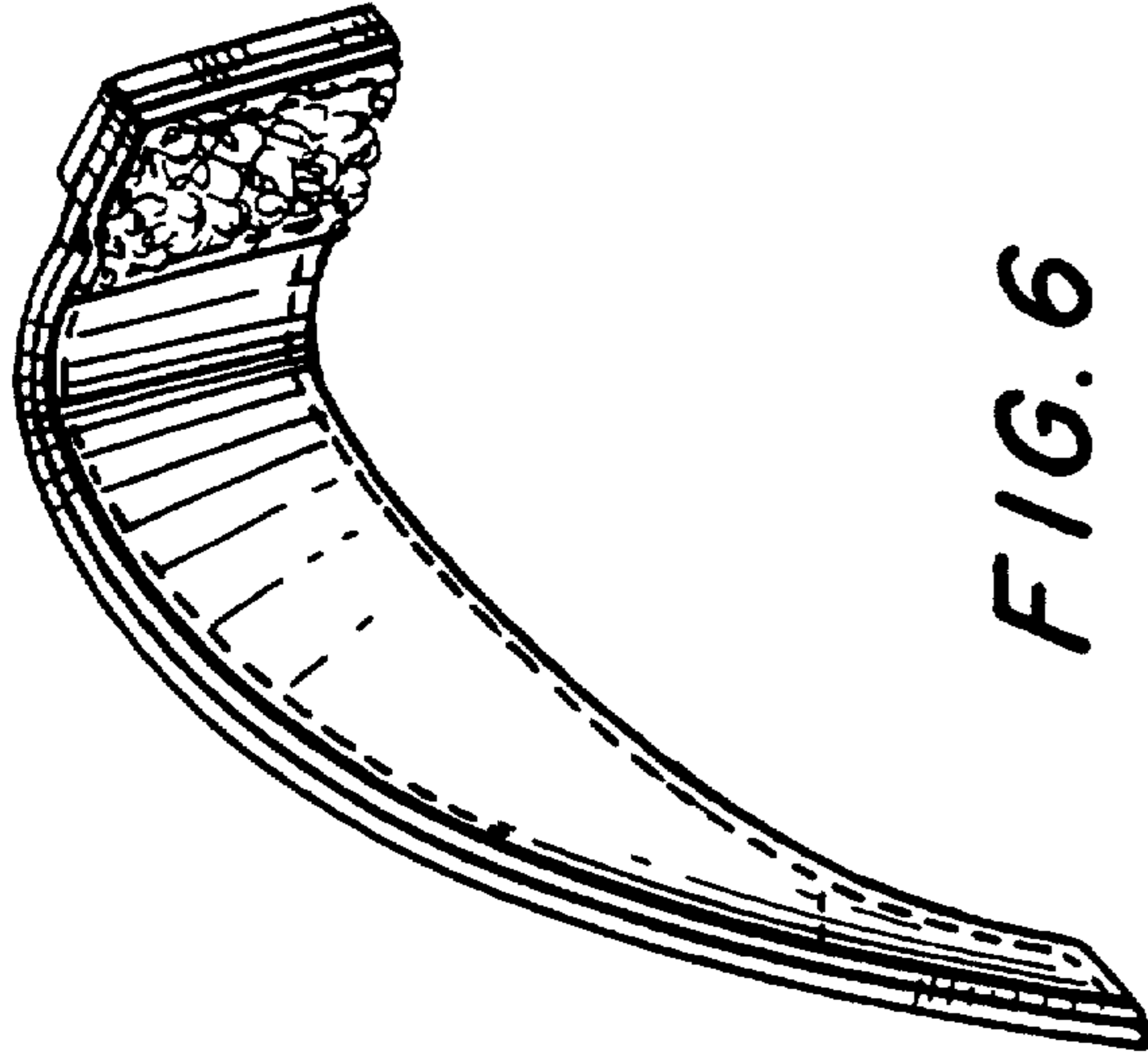

FIG. 6

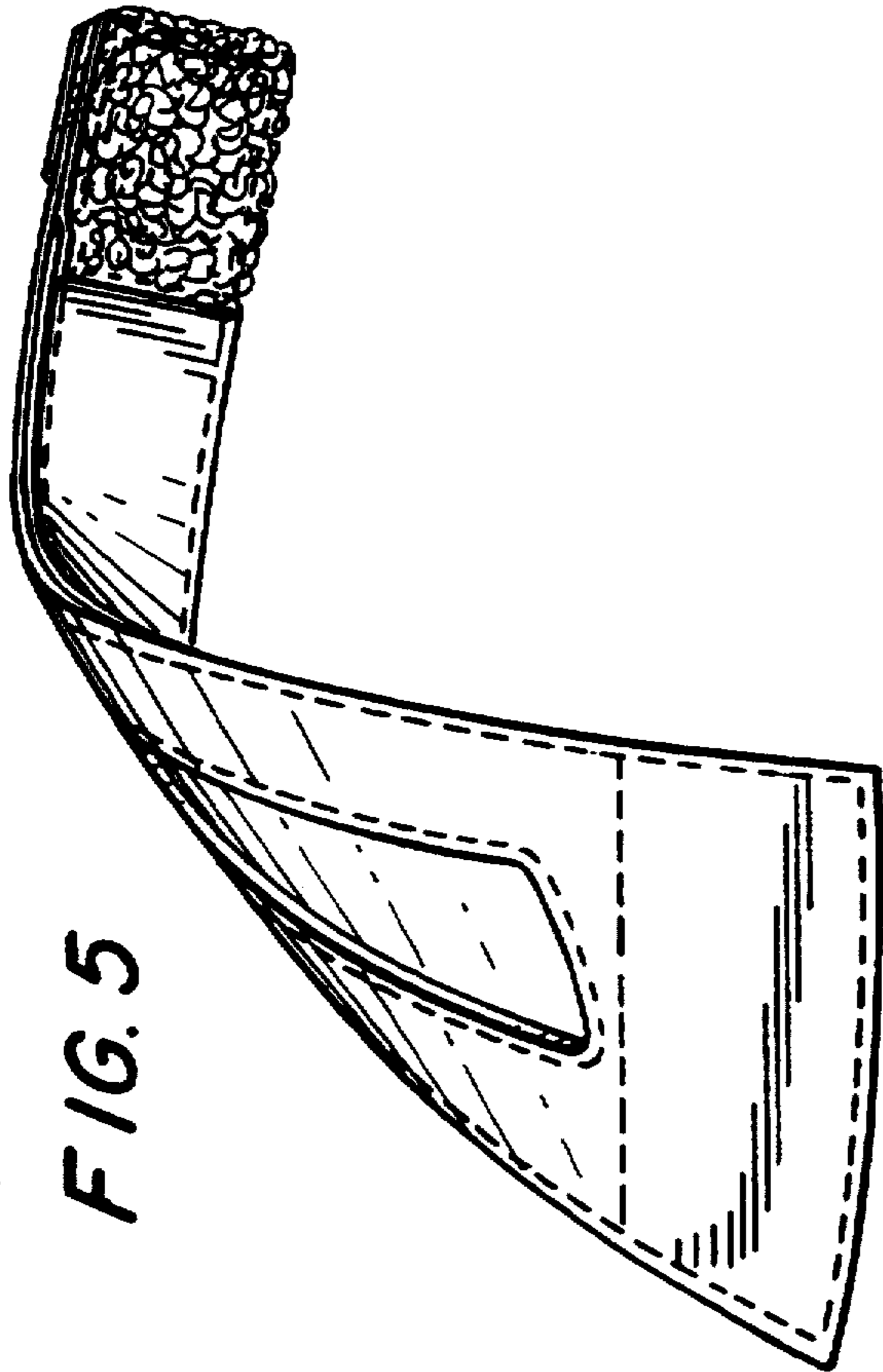

FIG. 5

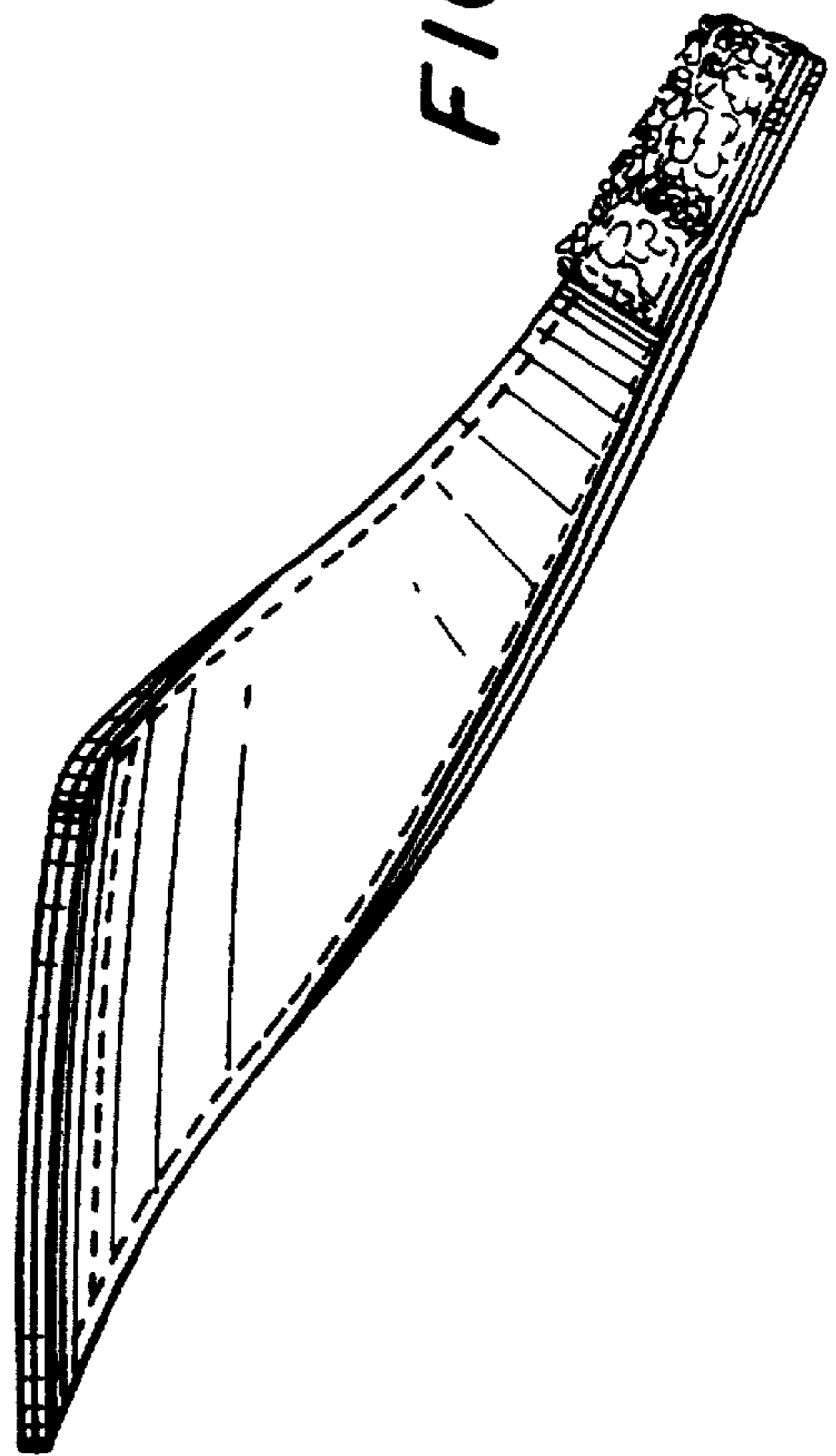

FIG. 7