



US00D351236S

United States Patent [19] Held

[11] Patent Number: **Des. 351,236**
[45] Date of Patent: **** Oct. 4, 1994**

[54] **COMBINED HEAT MASSAGER AND RECEPTACLE**

[75] Inventor: **Wolfgang Held**, Hard, Austria

[73] Assignee: **Metronic Electronic GmbH**, Fed. Rep. of Germany

[**] Term: **14 Years**

[21] Appl. No.: **878,889**

[22] Filed: **May 5, 1992**

[30] **Foreign Application Priority Data**

Jan. 10, 1992 [DE] Fed. Rep. of Germany M9200106.8

[52] U.S. Cl. **D24/215**

[58] Field of Search 128/24.1, 24.2, 24.3, 128/24.4, 32, 35, 36, 41, 44, 421; D24/214, 215

[56] **References Cited**

U.S. PATENT DOCUMENTS

- D. 204,921 5/1966 McNair D24/214 X
- D. 207,080 2/1967 McNair D24/214 X
- D. 263,872 4/1982 Rakocy et al. D24/214
- D. 323,034 1/1992 Reinstein D24/214 X
- 3,063,443 11/1962 Wahl 128/32

Primary Examiner—Stella Reid

Assistant Examiner—Eric Watterson
Attorney, Agent, or Firm—Speckman, Pauley & Fejer

[57] **CLAIM**

The ornamental design for a combined heat massager and receptacle, as shown and described.

DESCRIPTION

FIG. 1 is a top view of the combined heat massager and receptacle, showing my new design;
 FIG. 2 is a bottom plan view thereof;
 FIG. 3 is a side view thereof;
 FIG. 4 is a side view thereof, opposite that shown in FIG. 3;
 FIG. 5 is a rear view thereof;
 FIG. 6 is a front view thereof;
 FIG. 7 is a top plan view of the receptacle for the combined heat massager and receptacle showing my new design;
 FIG. 8 is a bottom plan view thereof;
 FIG. 9 is a side elevational view thereof;
 FIG. 10 is a side elevational view thereof;
 FIG. 11 is a rear view thereof;
 FIG. 12 is a front elevational view thereof; and,
 FIG. 13 is a perspective view of the combined heat massager and receptacle showing my new design, the broken line showing is for illustrative purposes only and forms no part of the claimed design.

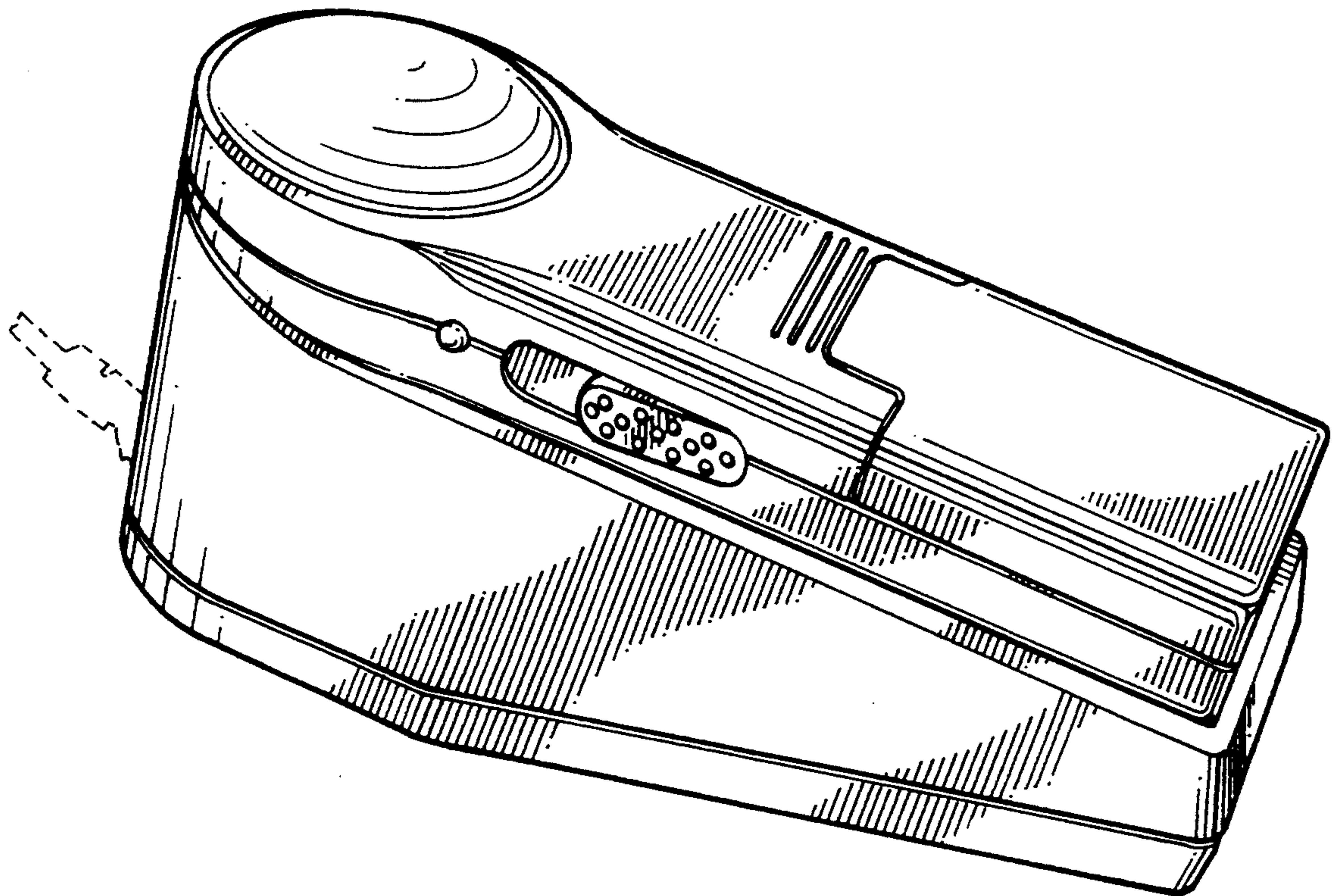

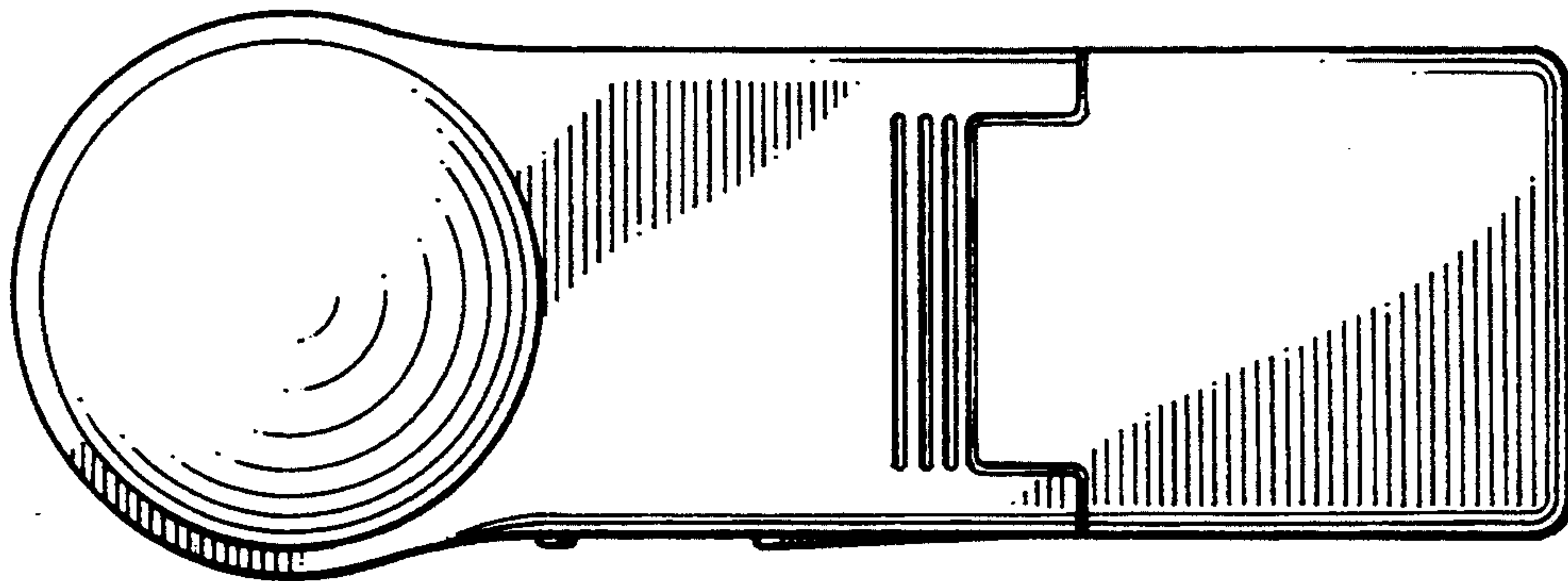

FIG. 1

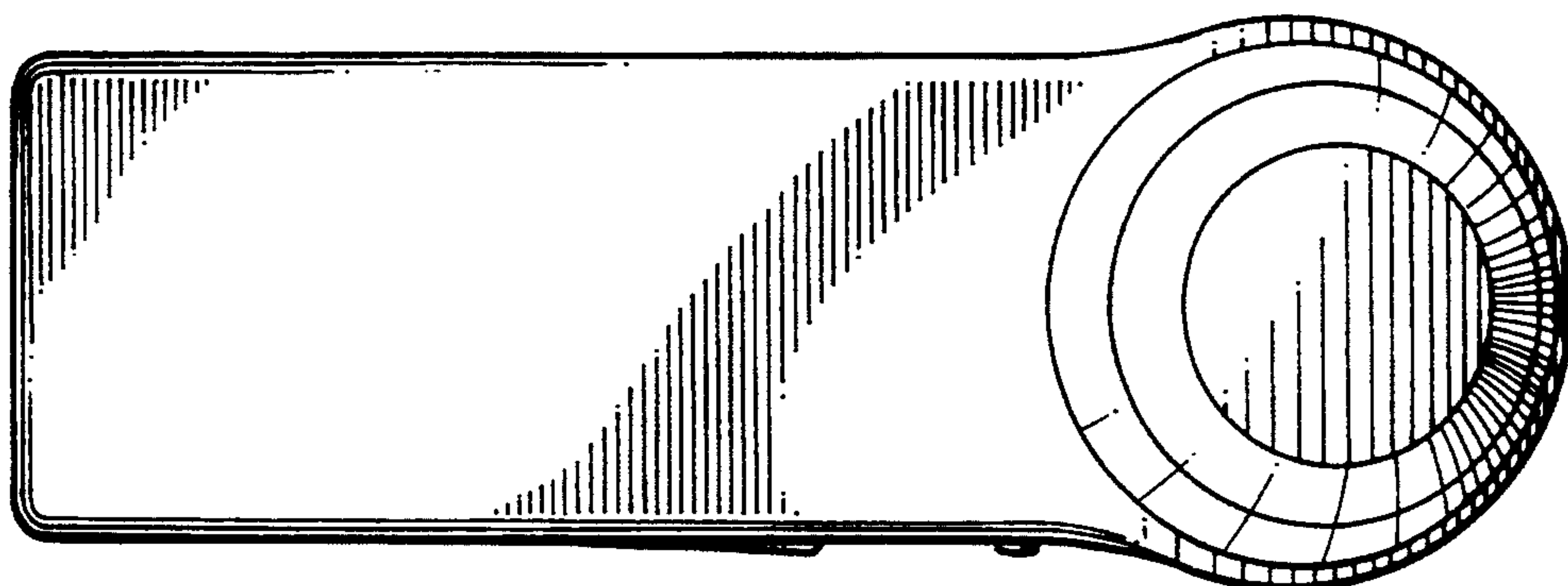

FIG. 2

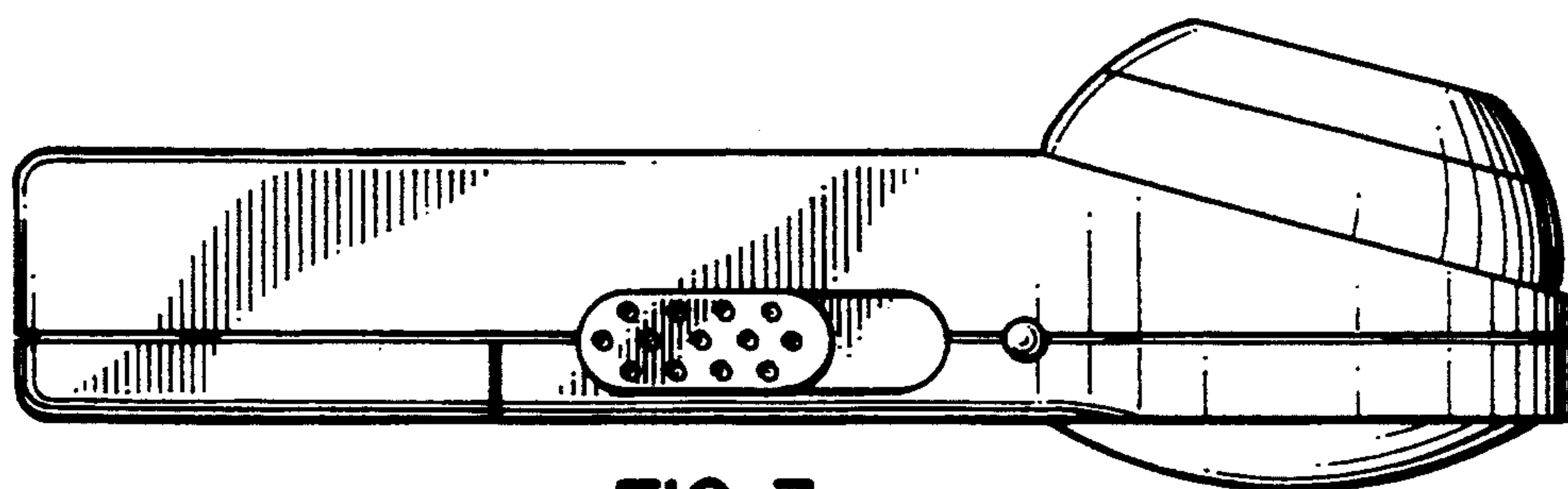

FIG. 3

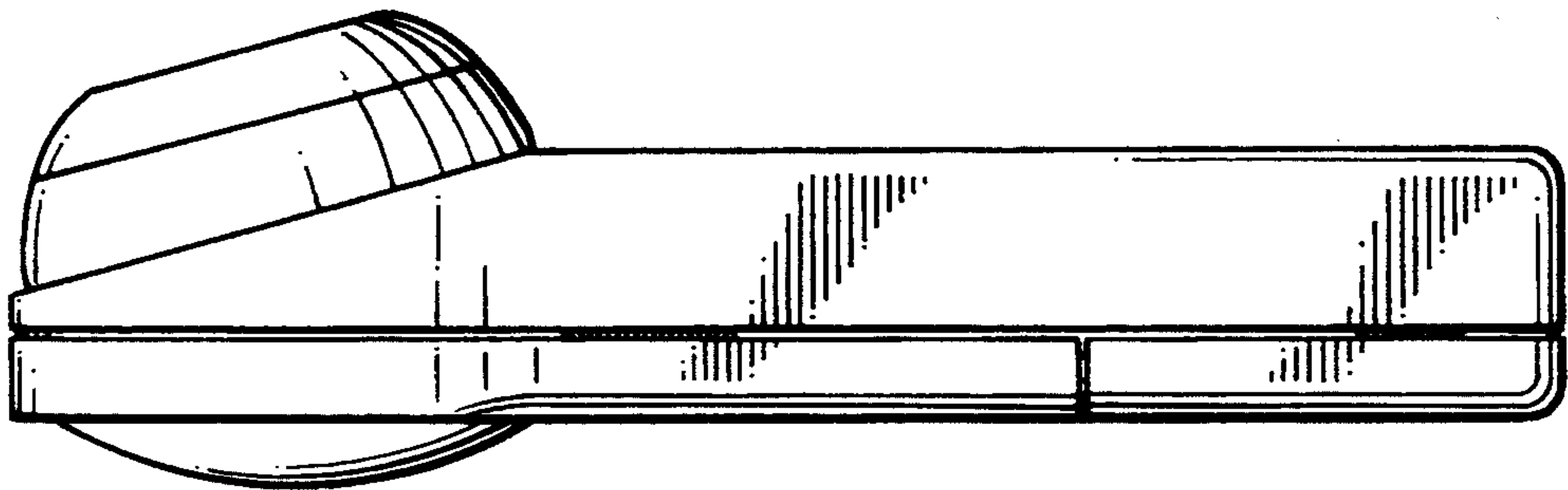

FIG. 4

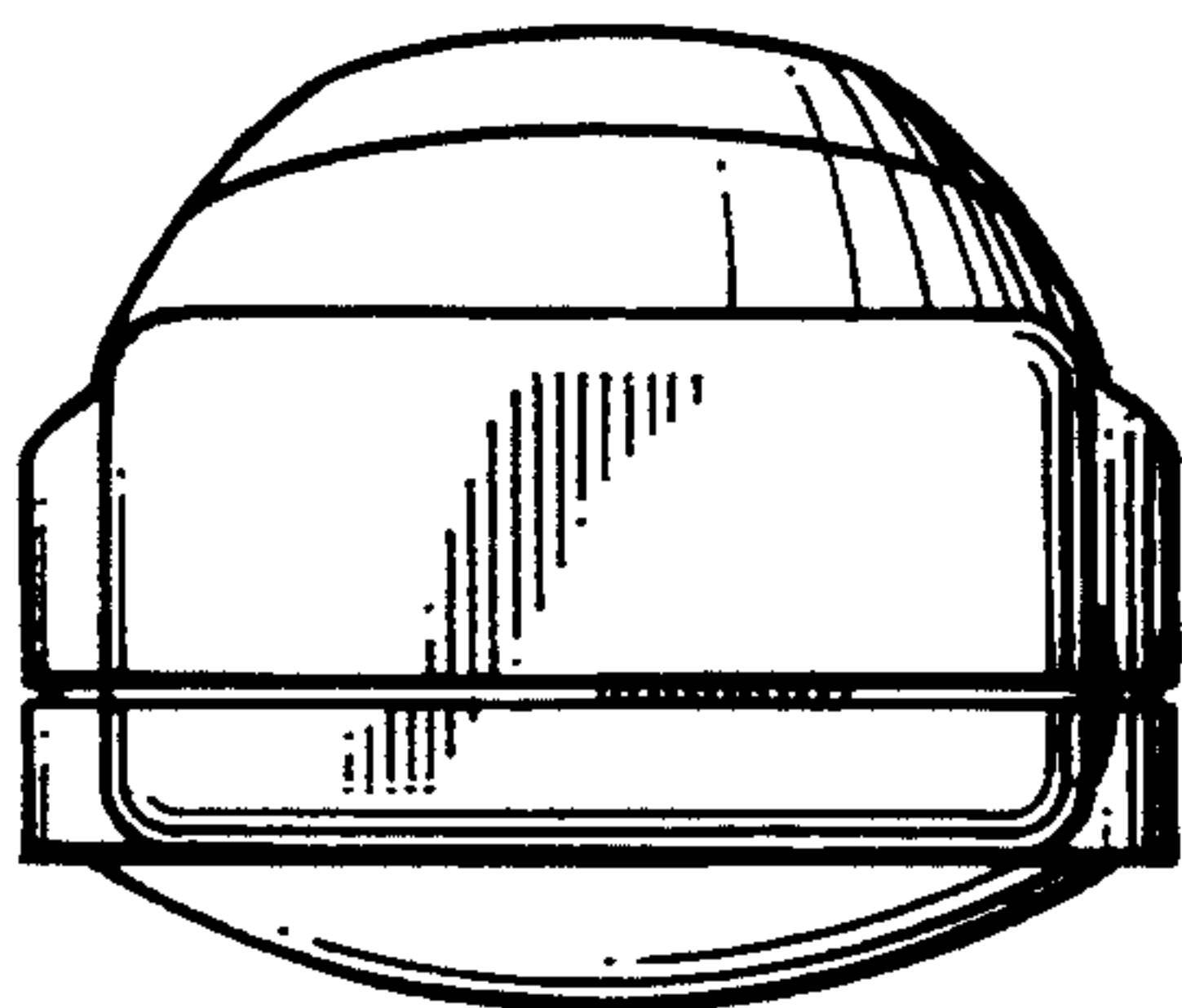

FIG. 5

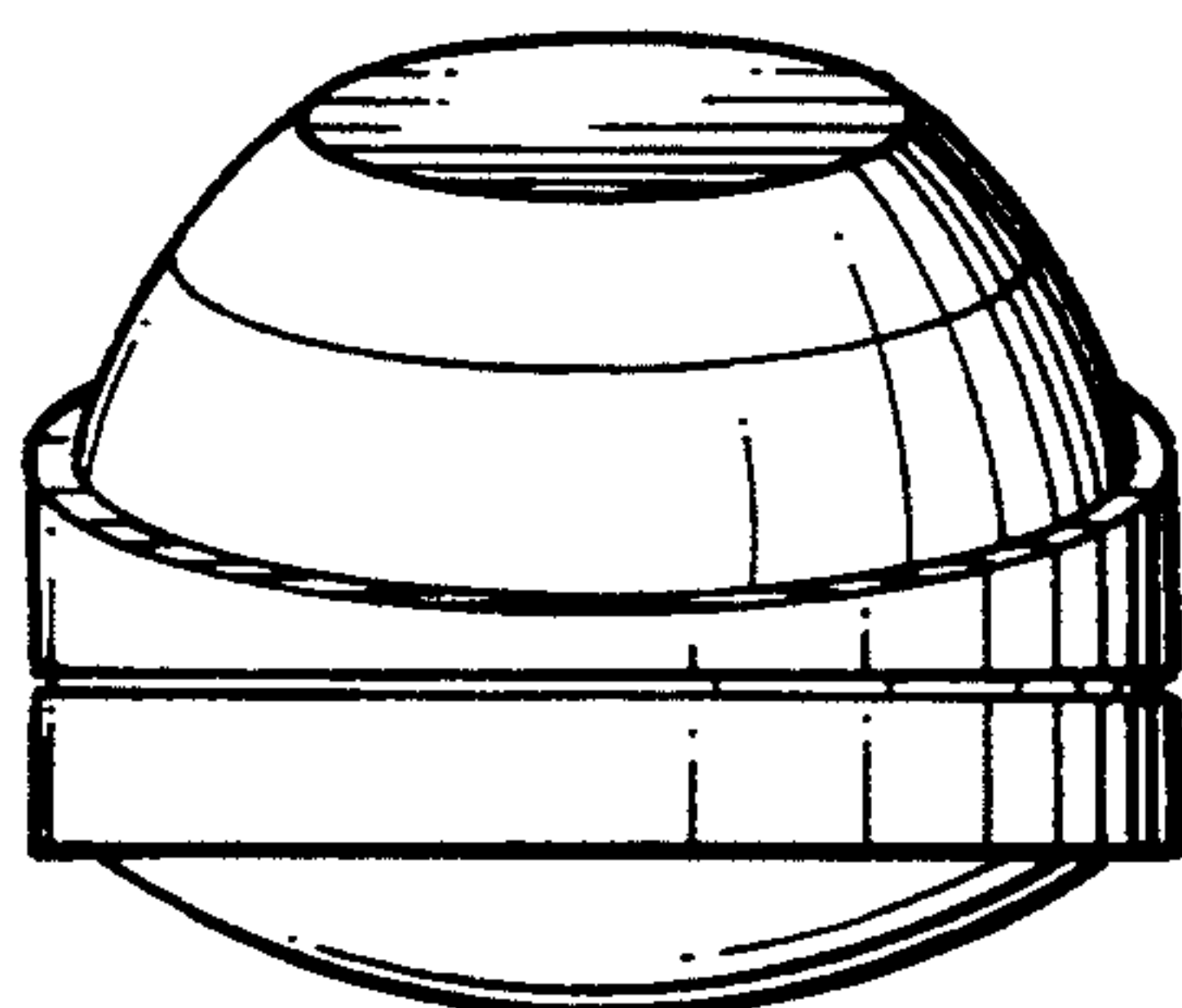

FIG. 6

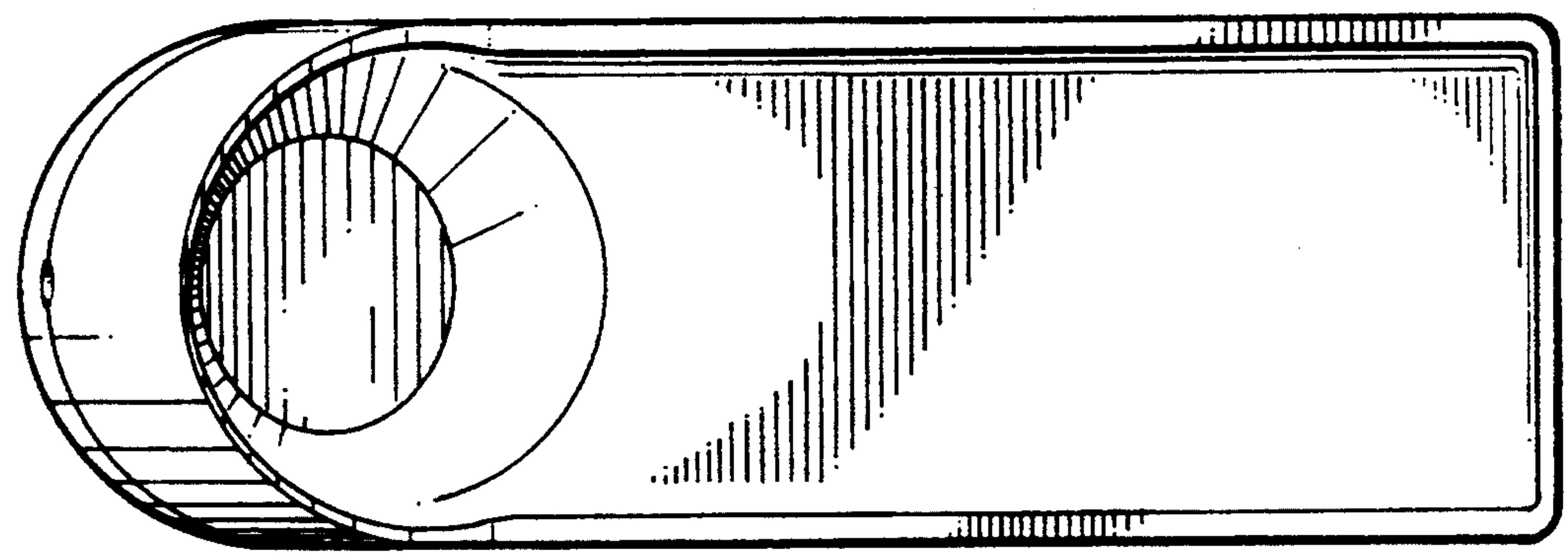

FIG. 7

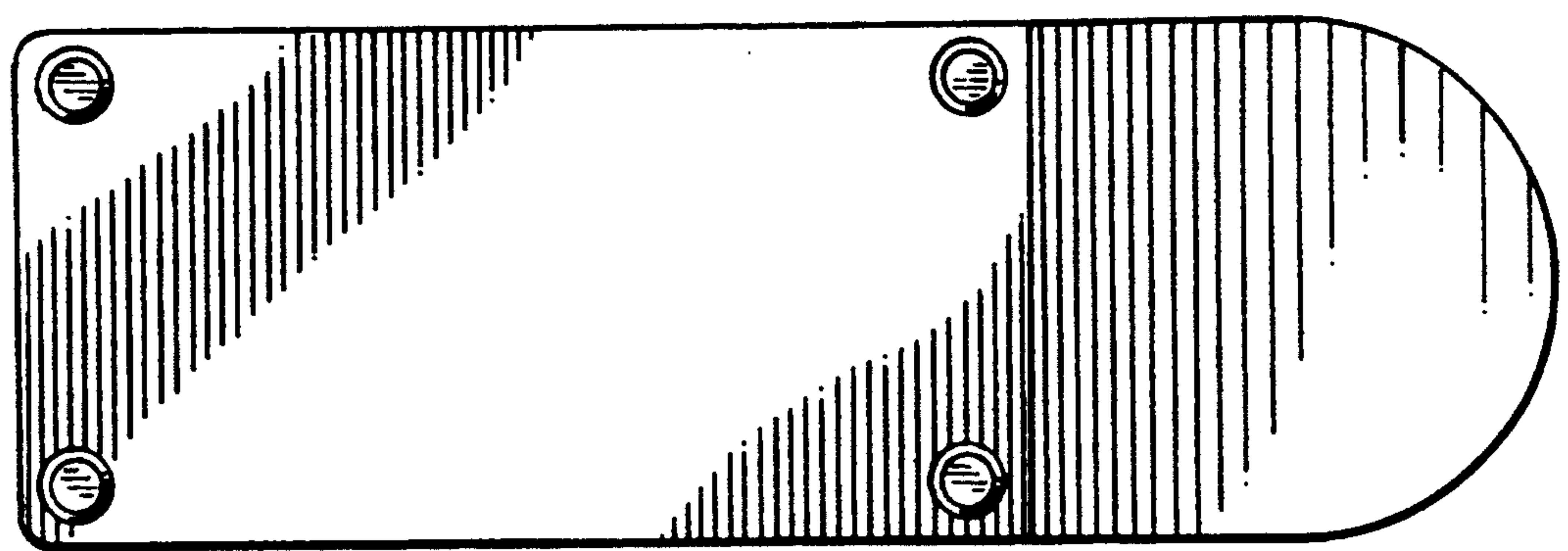

FIG. 8

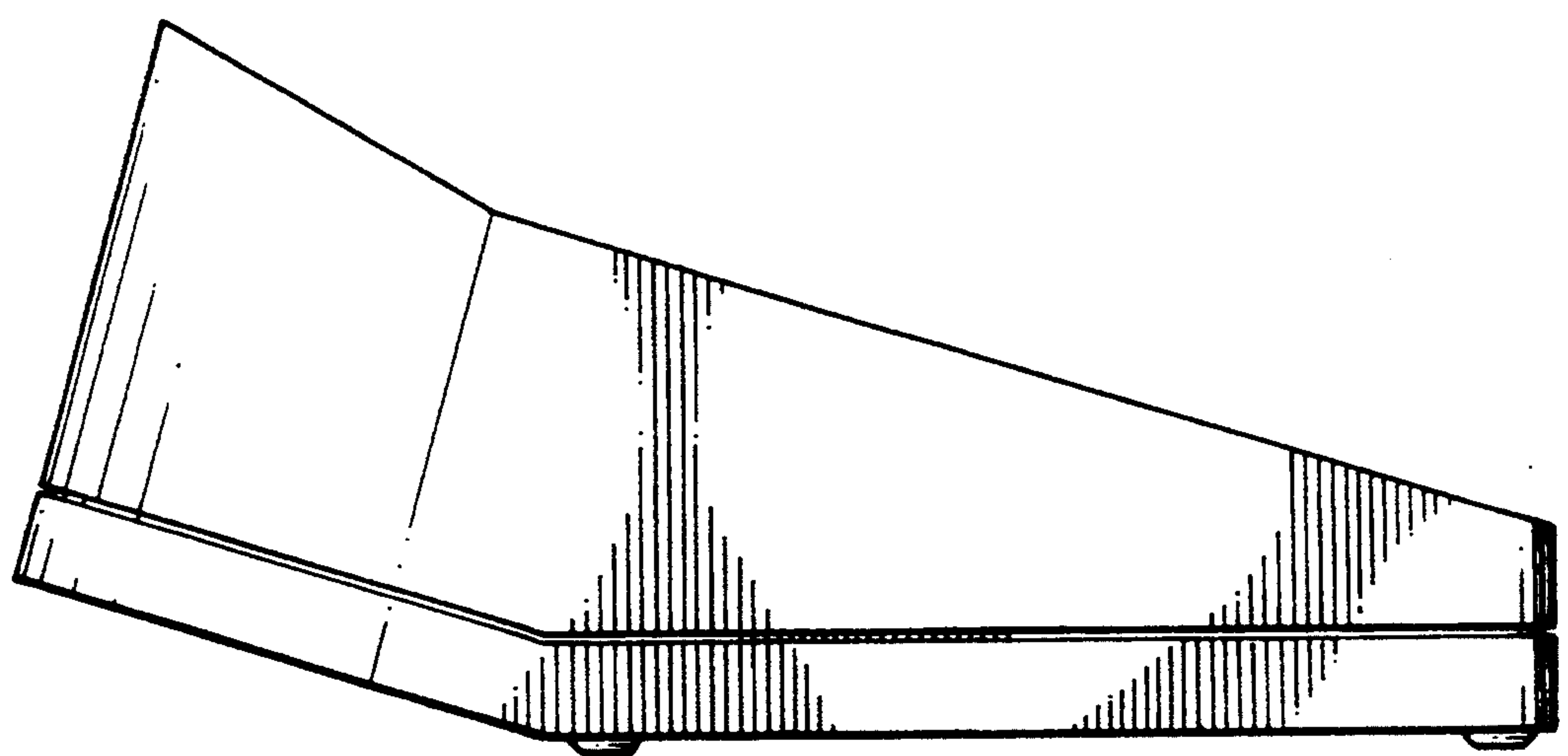

FIG. 9

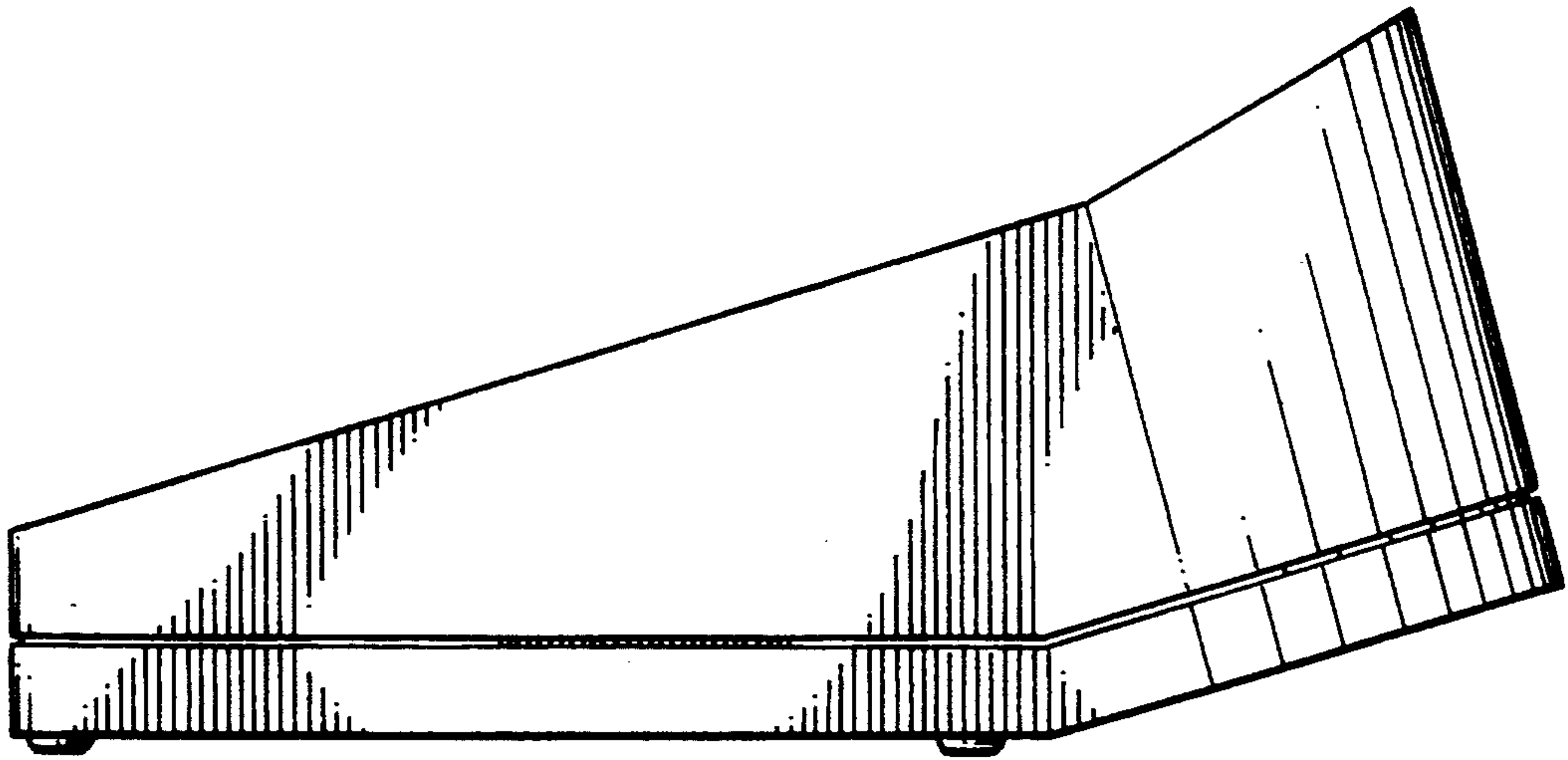

FIG. 10

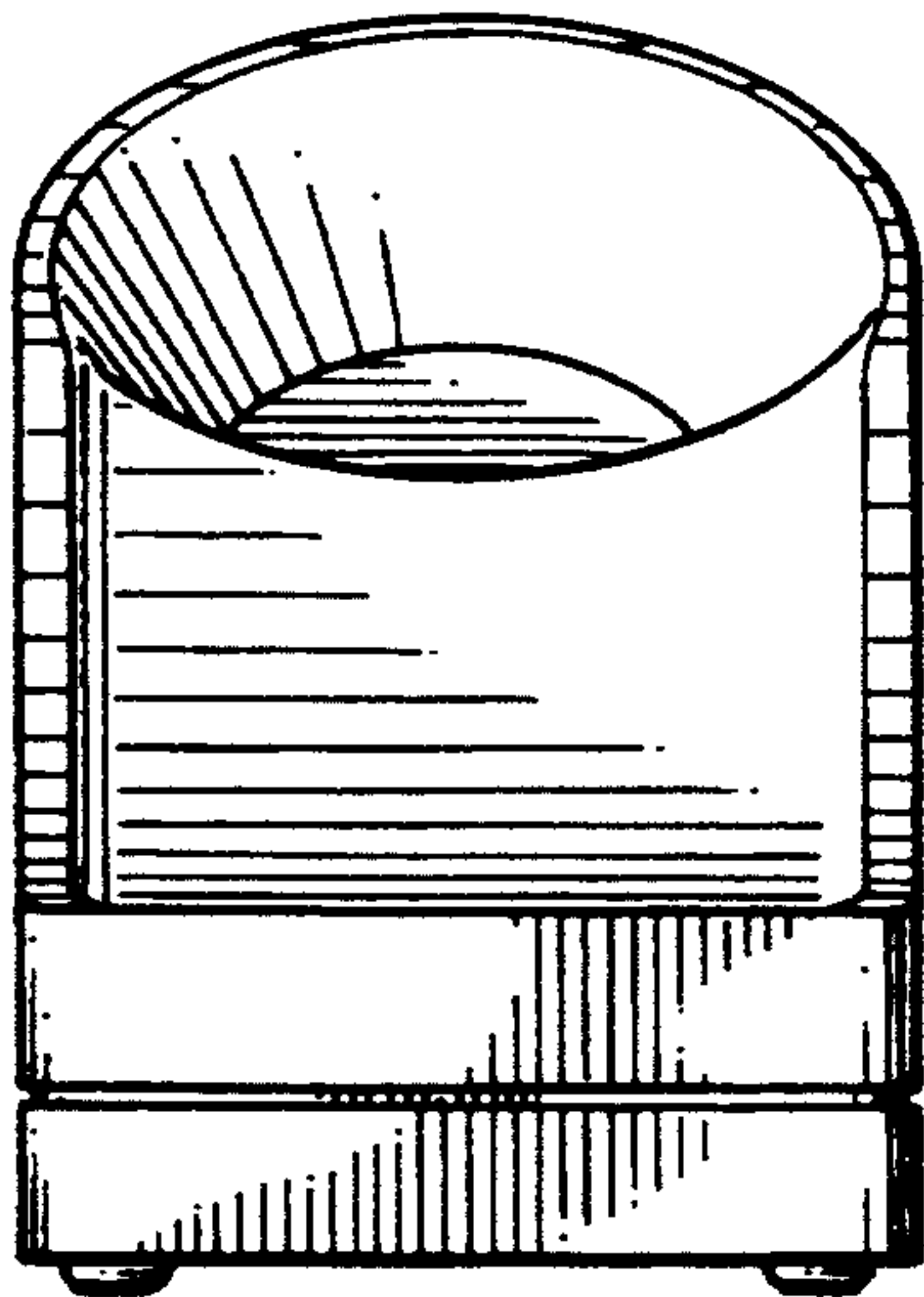

FIG. 11

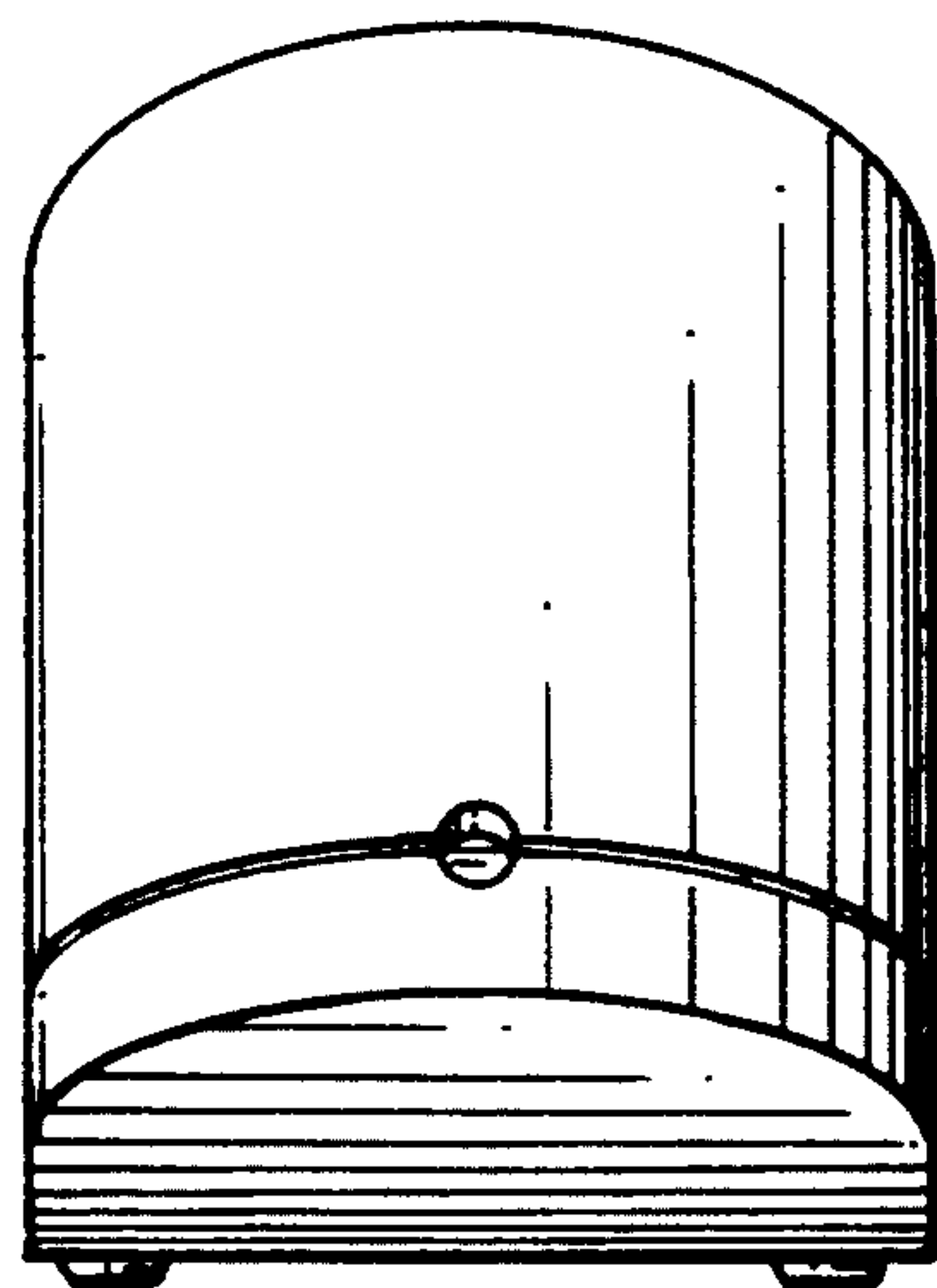

FIG. 12

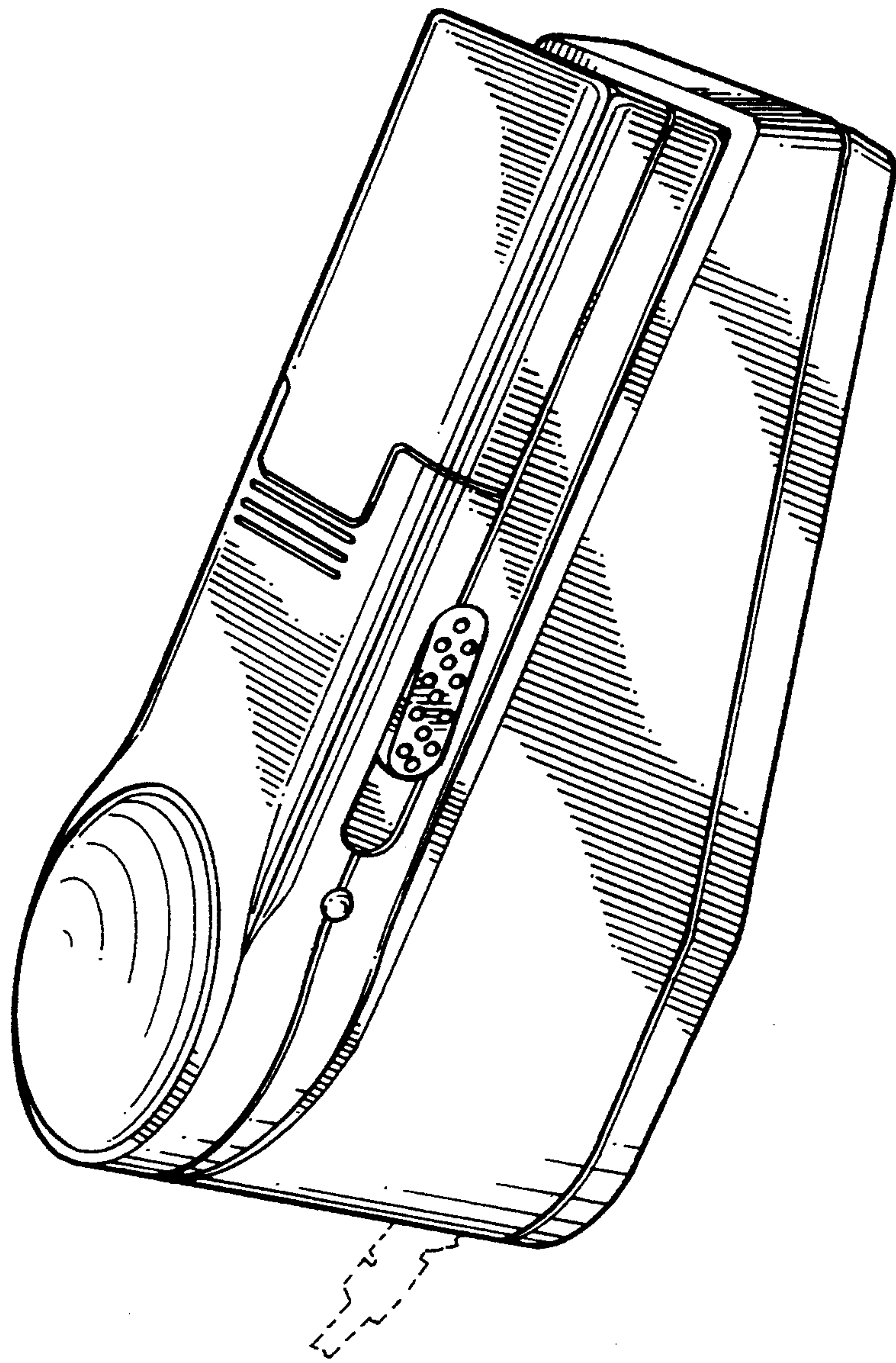

FIG. 13