



US00D351138S

# United States Patent [19]

[11] Patent Number: Des. 351,138

Shimizu et al.

[45] Date of Patent: \*\* Oct. 4, 1994

## [54] SUB-UNIT FOR DATA TRANSMISSION

[75] Inventors: **Norio Shimizu; Shingo Iwasawa**, both of Tokyo, Japan

[73] Assignee: **Koyo Electronics Industries Co., Ltd.**, Tokyo, Japan

[\*\*] Term: **14 Years**

[21] Appl. No.: **4,476**

[22] Filed: **Feb. 2, 1993**

### [30] Foreign Application Priority Data

Aug. 3, 1992 [JP] Japan ..... 4-23215

Aug. 3, 1992 [JP] Japan ..... 4-23216

[52] U.S. Cl. .... **D13/152**

[58] Field of Search ..... 361/728, 730, 736, 823; 200/6 B; 439/709; 174/138 F; D13/162, 164, 152; D14/107

### [56] References Cited

#### U.S. PATENT DOCUMENTS

D. 333,461 2/1993 Shimizu et al. .... D13/162

3,560,632 2/1971 Wallace ..... 174/138 F

4,415,044 11/1983 Davis ..... 174/138 F

4,729,059 3/1988 Wang ..... 439/709 X

#### FOREIGN PATENT DOCUMENTS

2543781 10/1984 France ..... 361/730

#### OTHER PUBLICATIONS

Programmable controllers on cover of Koyo publication.

*Primary Examiner*—Wallace R. Burke

*Assistant Examiner*—Joel Sincavage

*Attorney, Agent, or Firm*—Sughrue, Mion, Zinn, Macpeak & Seas

### [57] CLAIM

The ornamental design for a sub-unit for data transmission, as shown and described.

### DESCRIPTION

FIG. 1 is a front, top and right side perspective view of a sub-unit for data transmission showing our new design;

FIG. 2 is a top plan view thereof;

FIG. 3 is a front elevational view thereof;

FIG. 4 is a left side elevational view thereof;

FIG. 5 is a right side elevational view thereof;

FIG. 6 is a rear elevational view thereof with the broken line showing included for the purpose of illustrating environmental structure which forms no part of the claimed design;

FIG. 7 is a bottom plan view thereof;

FIG. 8 is a front, top and right side perspective view of an another embodiment of the sub-unit for data transmission showing our new design;

FIG. 9 is a top plan view thereof;

FIG. 10 is a bottom plan view thereof;

FIG. 11 is a front elevational view thereof;

FIG. 12 is a rear elevational view thereof with the broken line showing included for the purpose of illustrating environmental structure which forms no part of the claimed design;

FIG. 13 is a left side elevational view thereof; and,

FIG. 14 is a right side elevational view thereof.

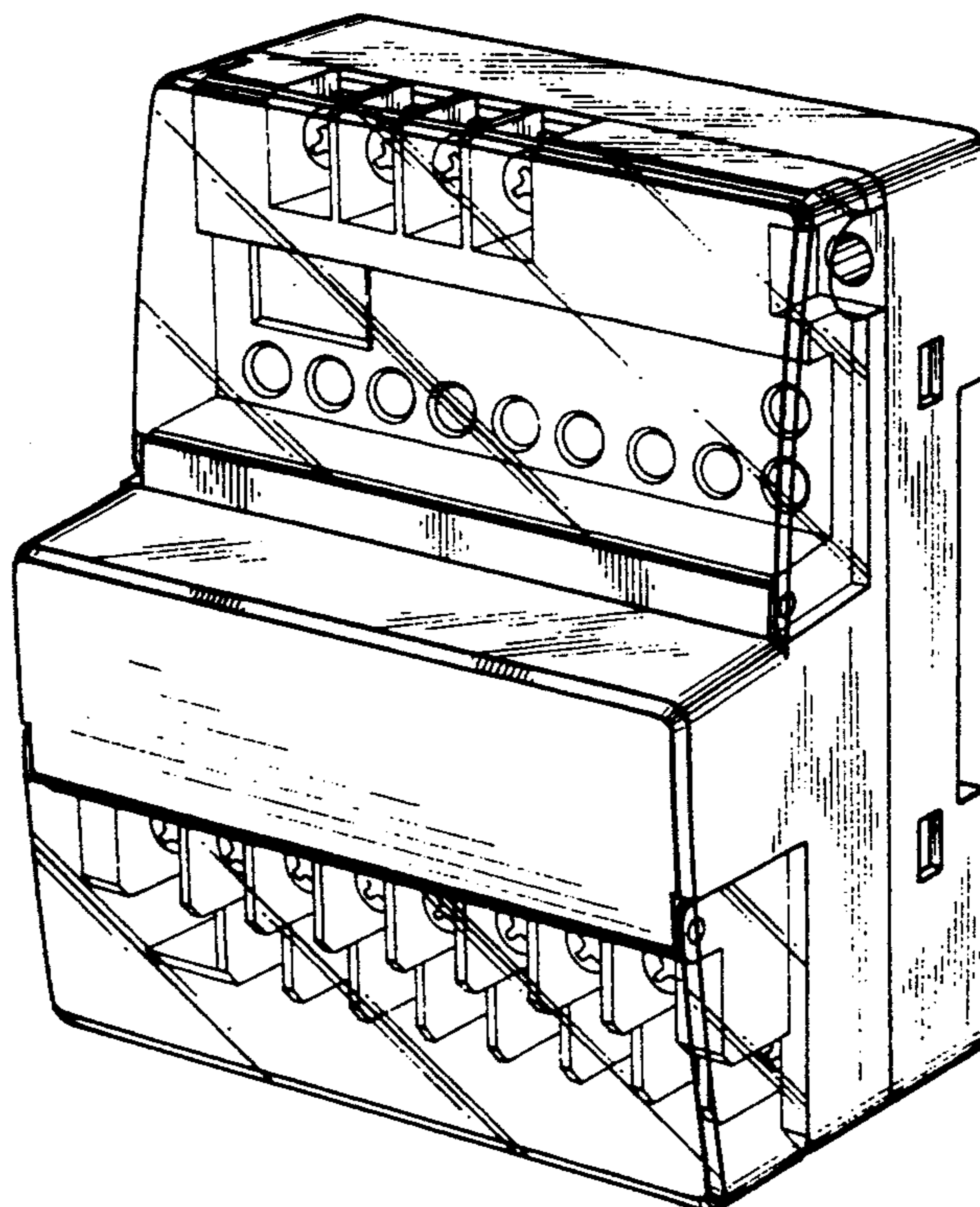

FIG. 1

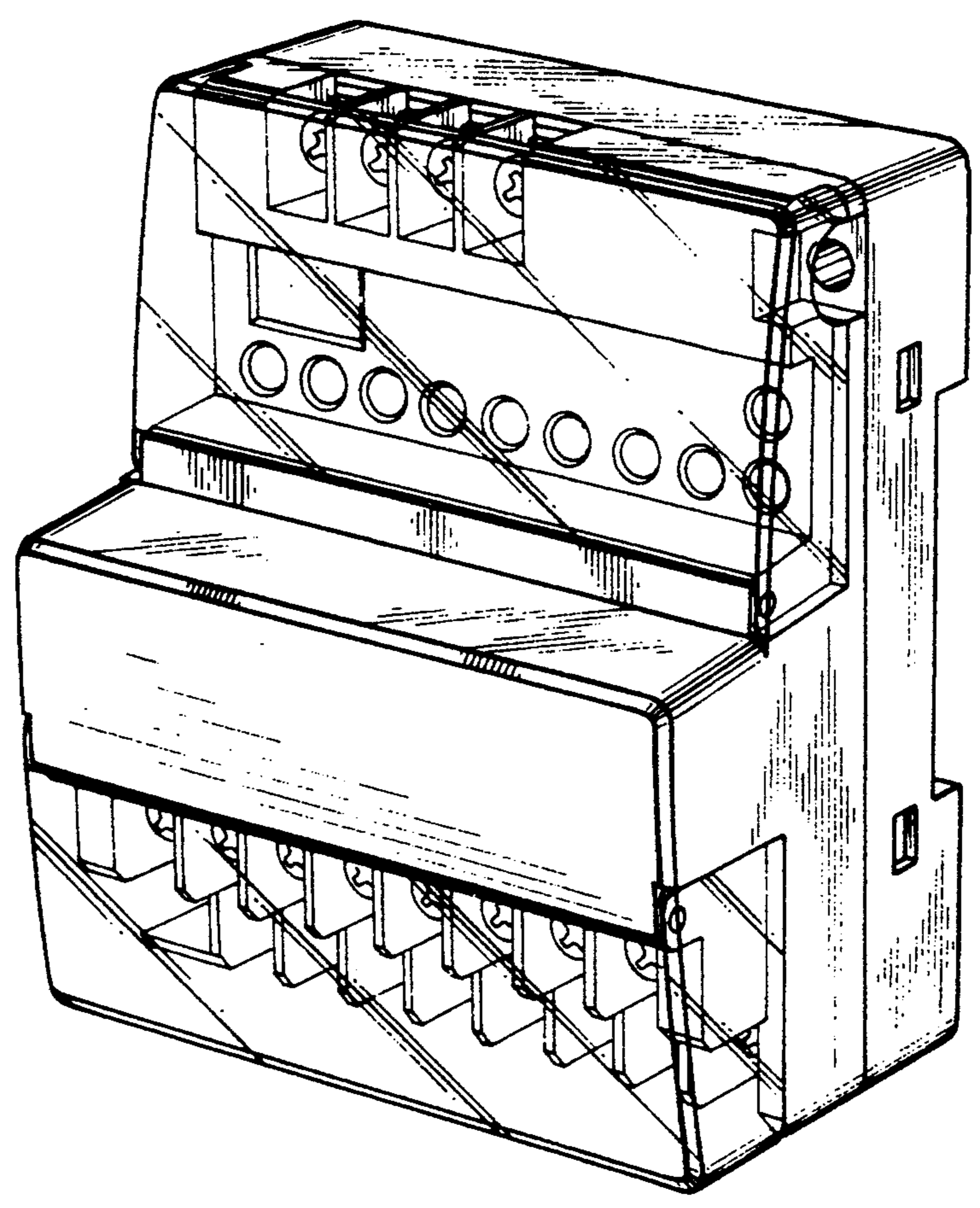

FIG. 2

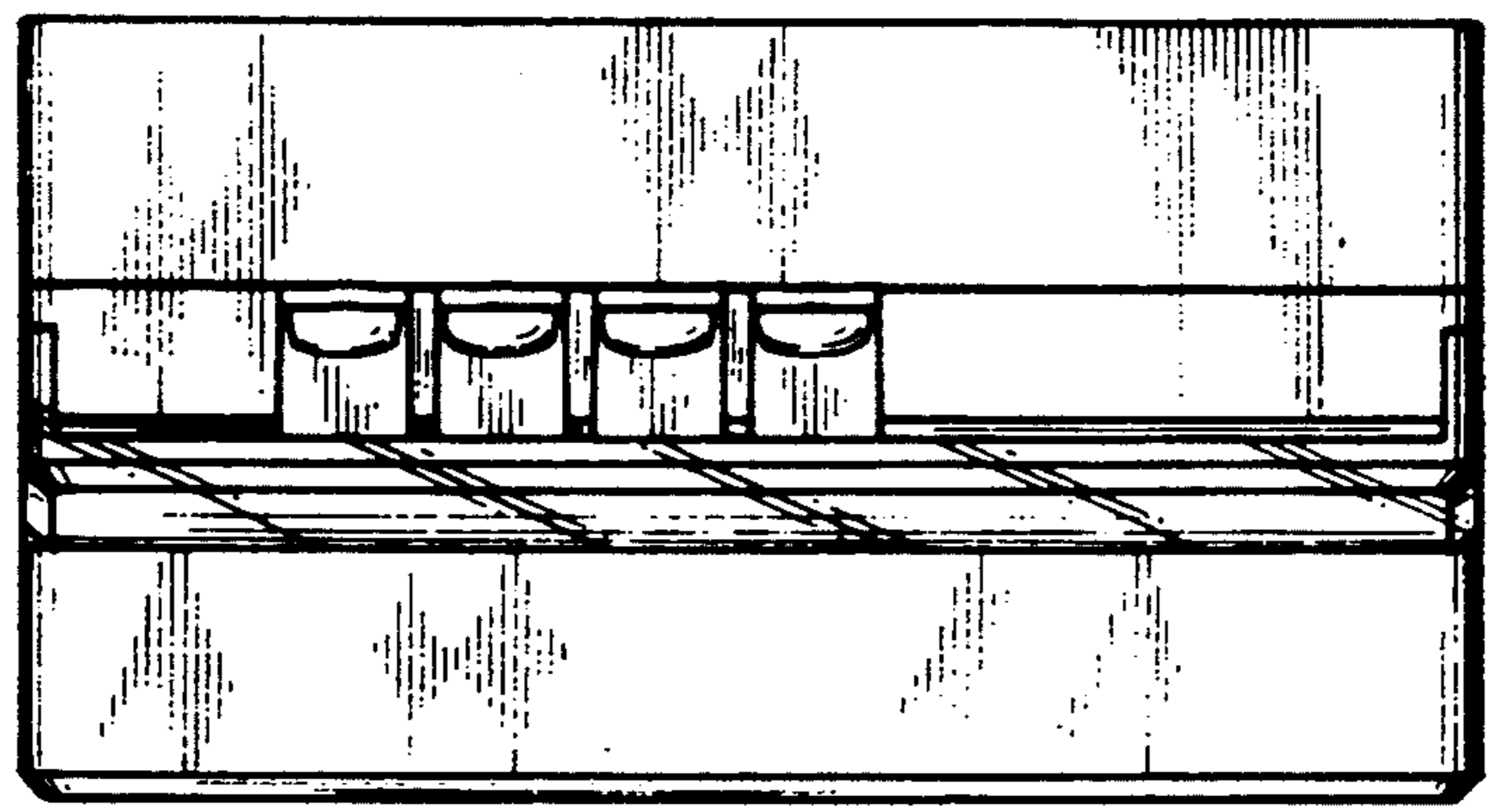



FIG. 3

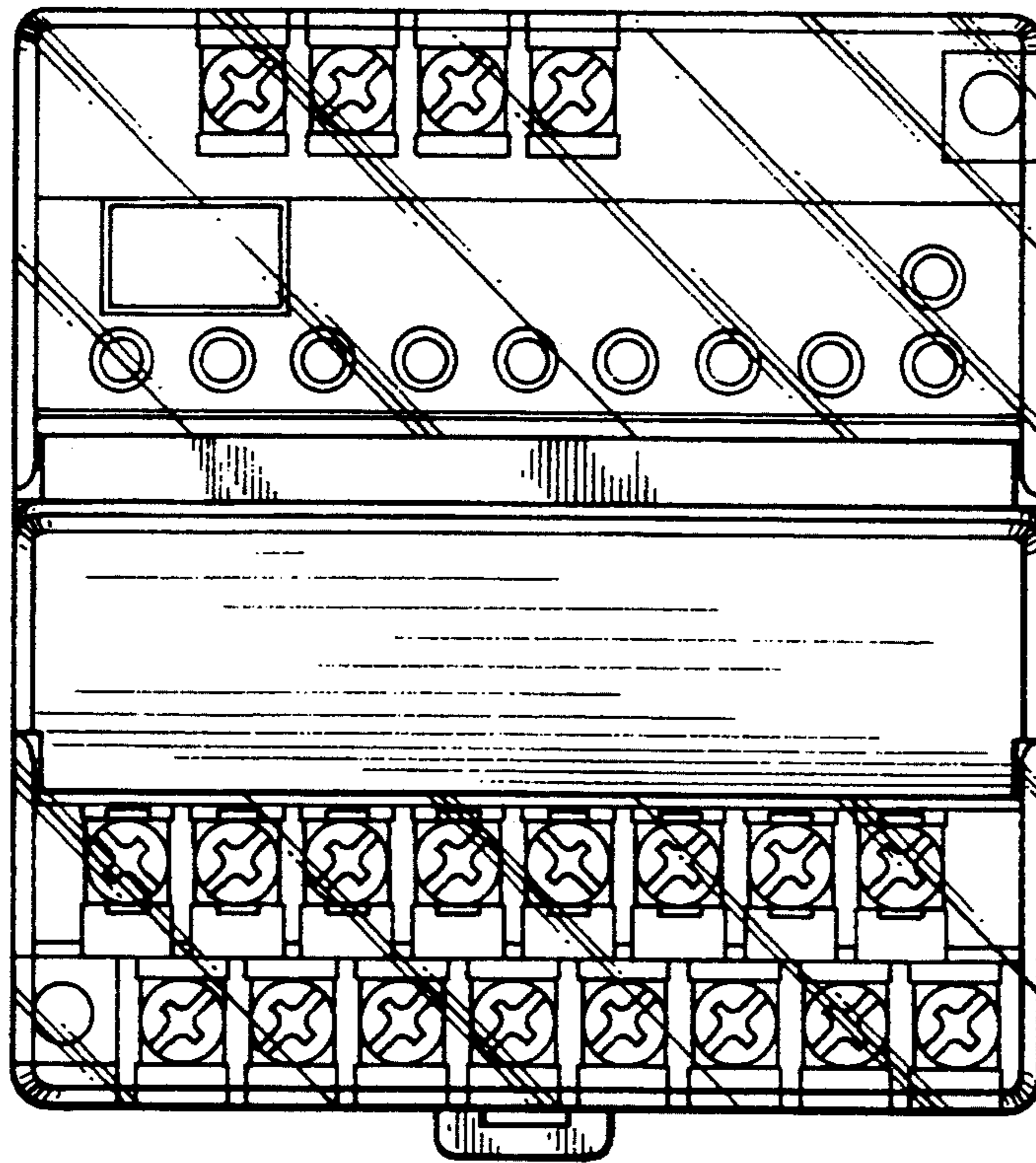

FIG. 4

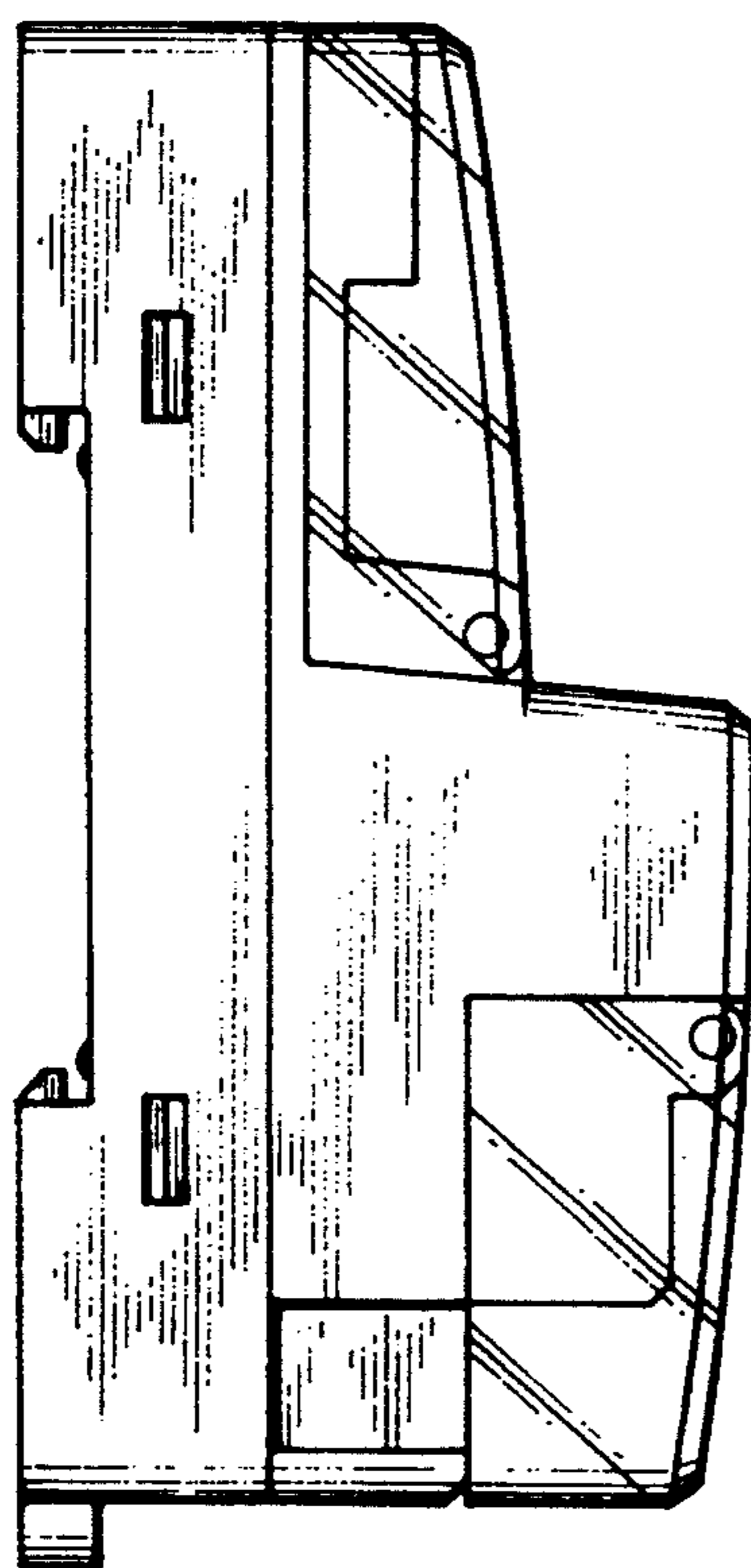

FIG. 5

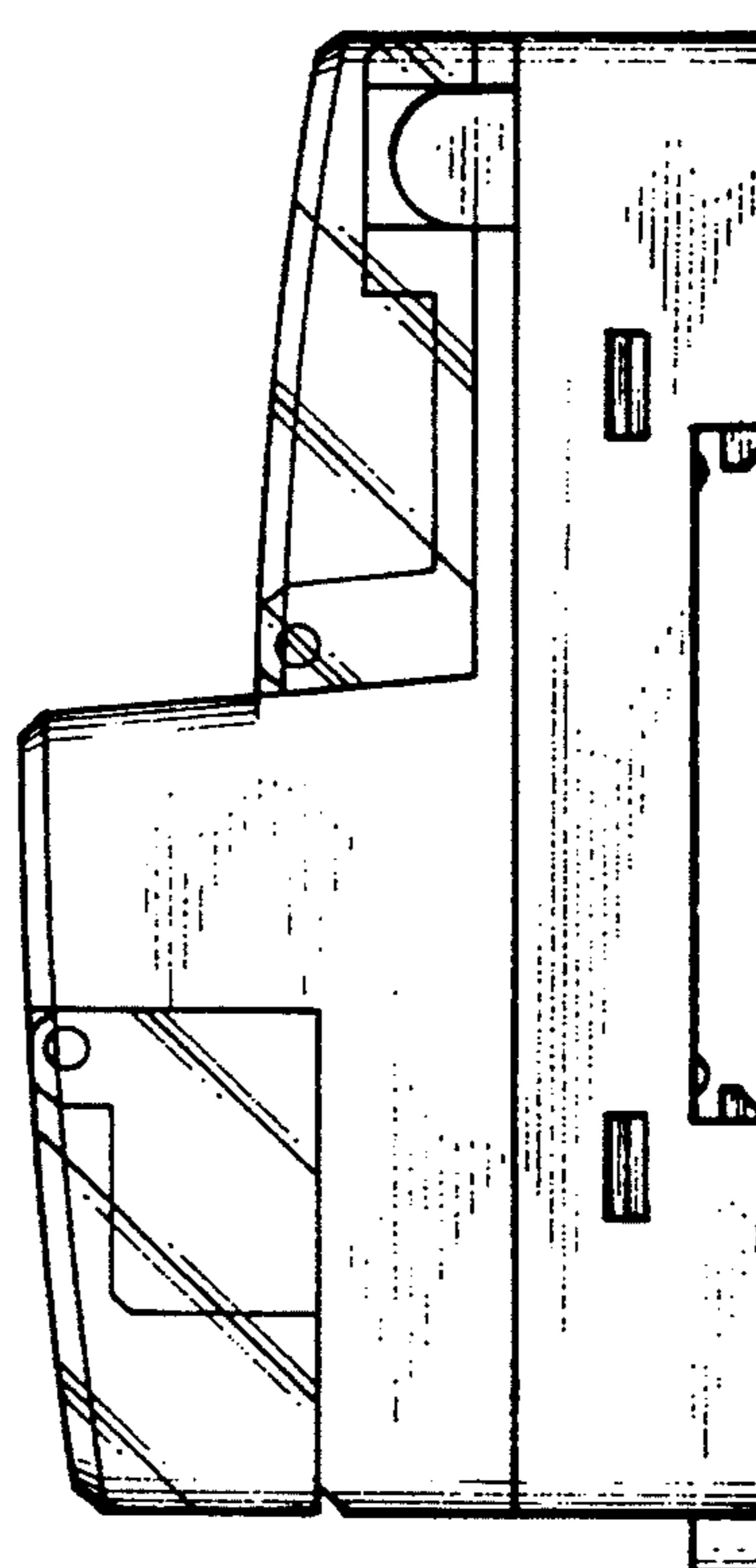

FIG. 6

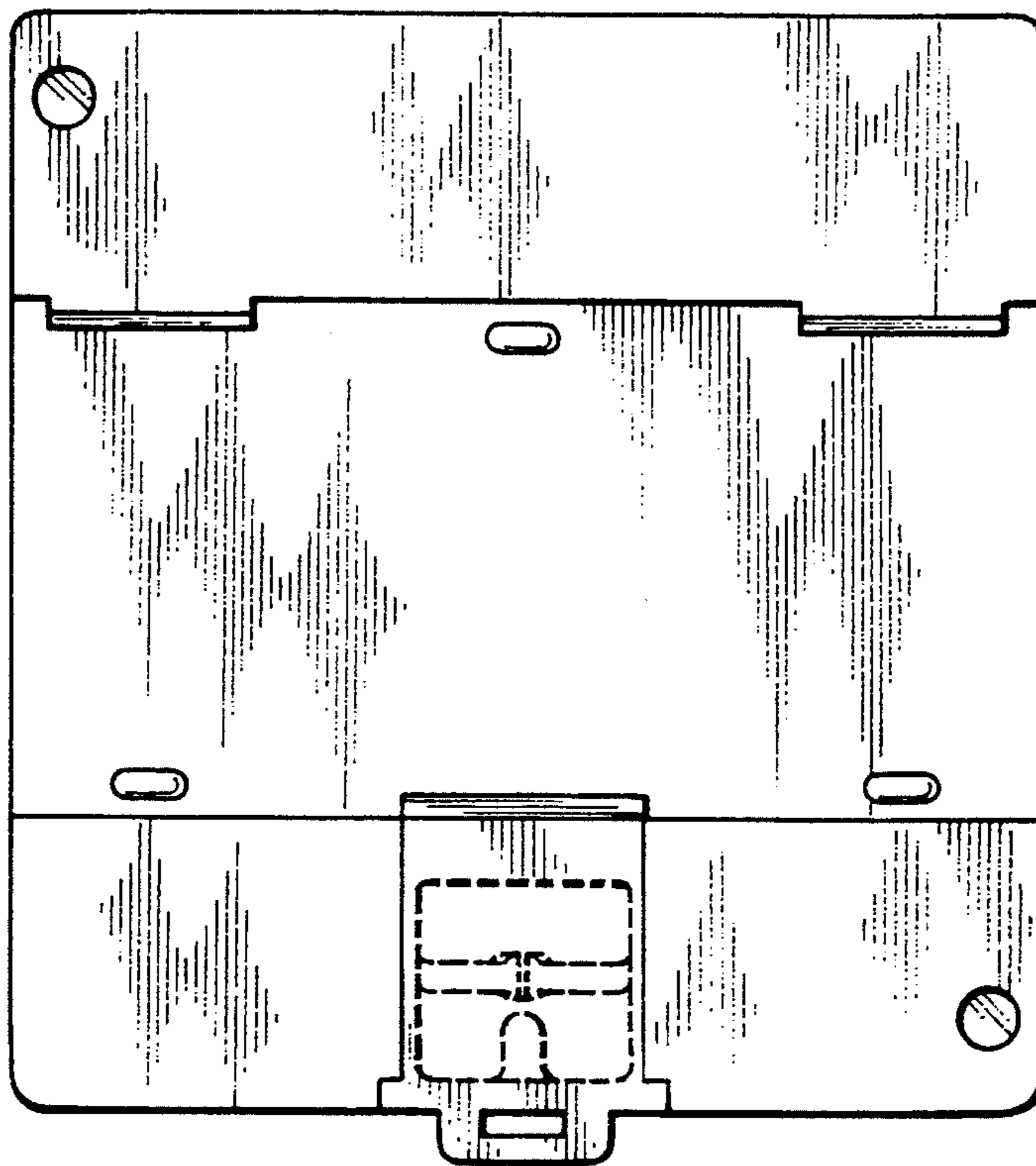
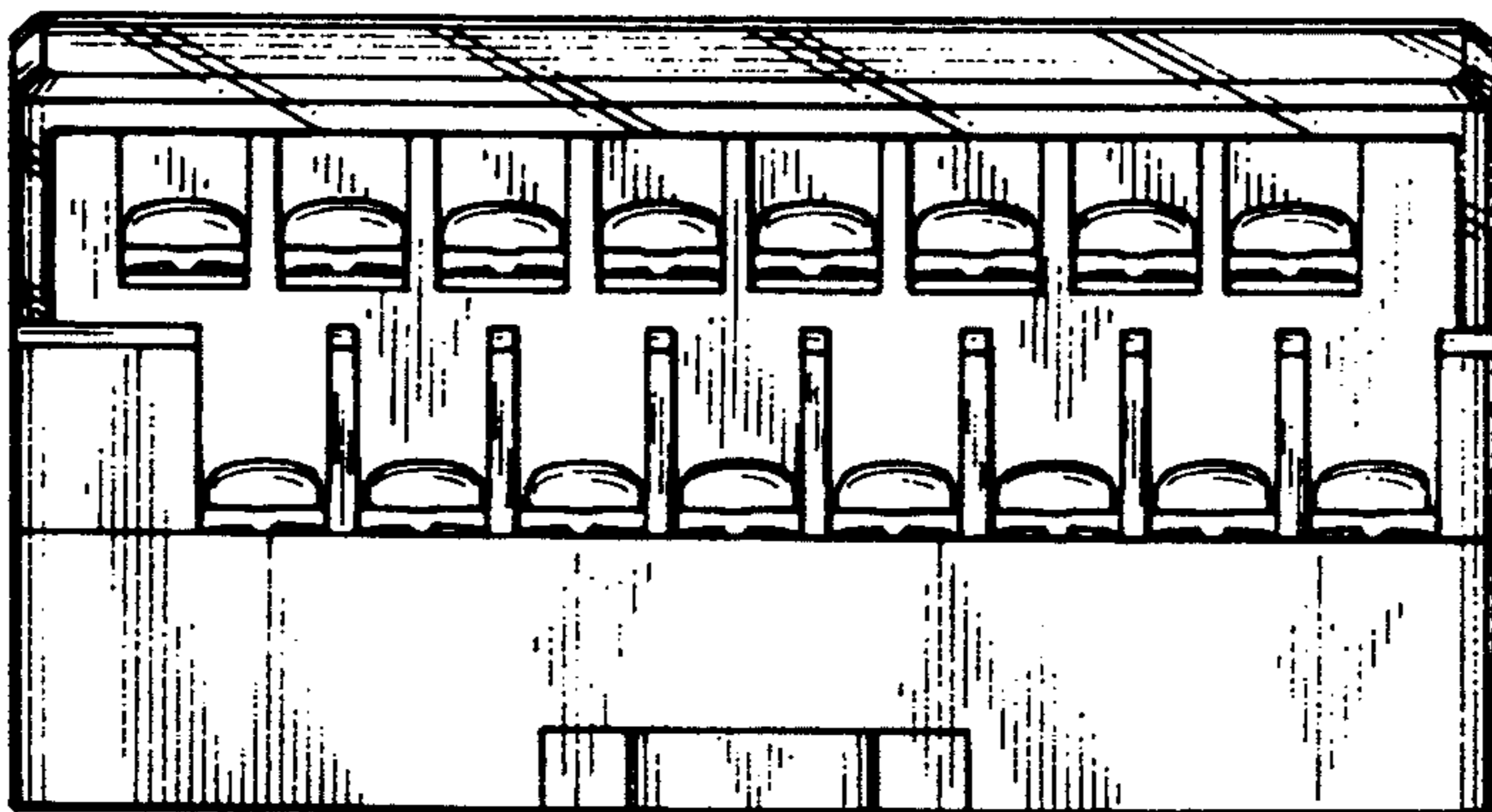
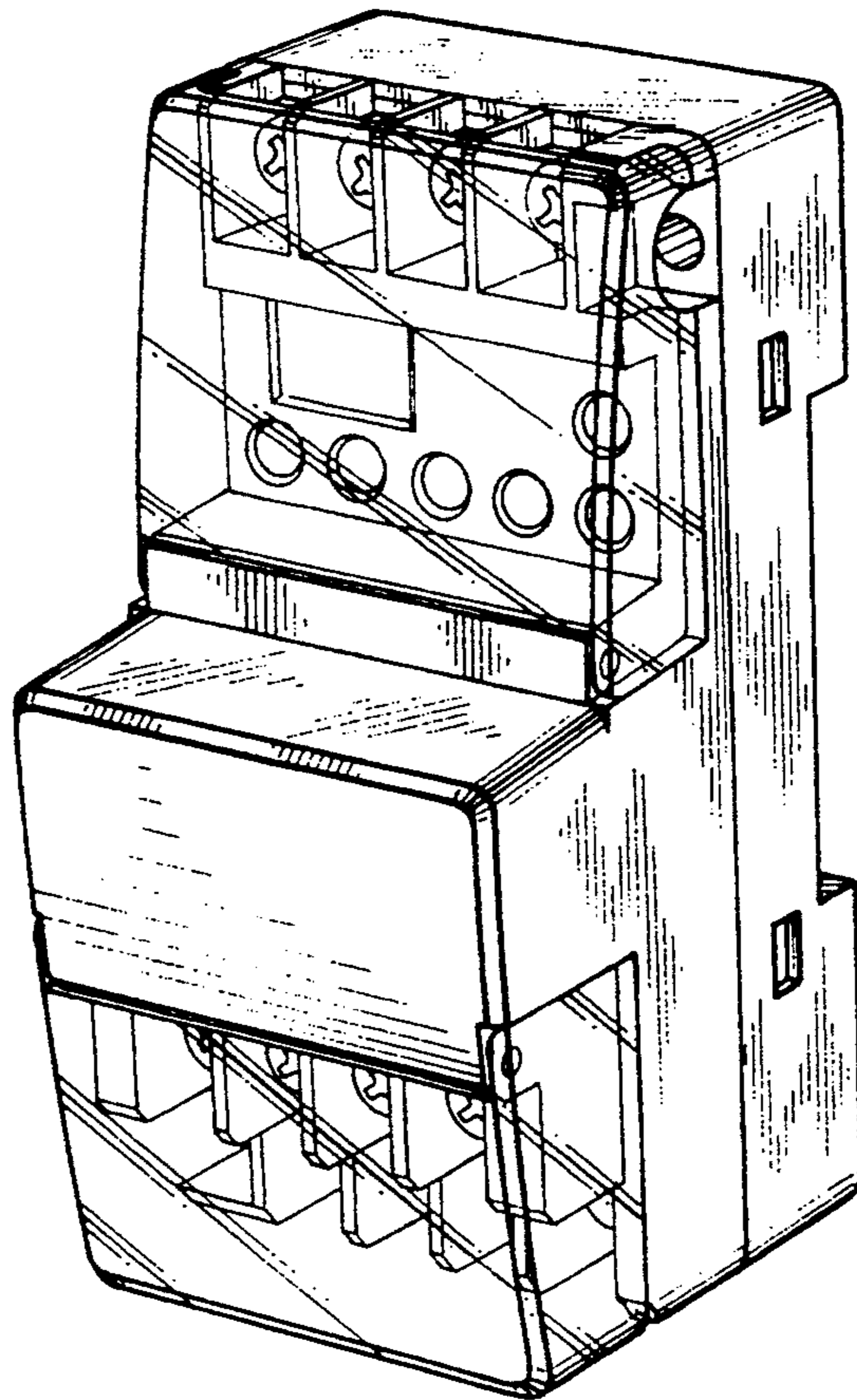

FIG. 7



*FIG. 8*



*FIG. 9*

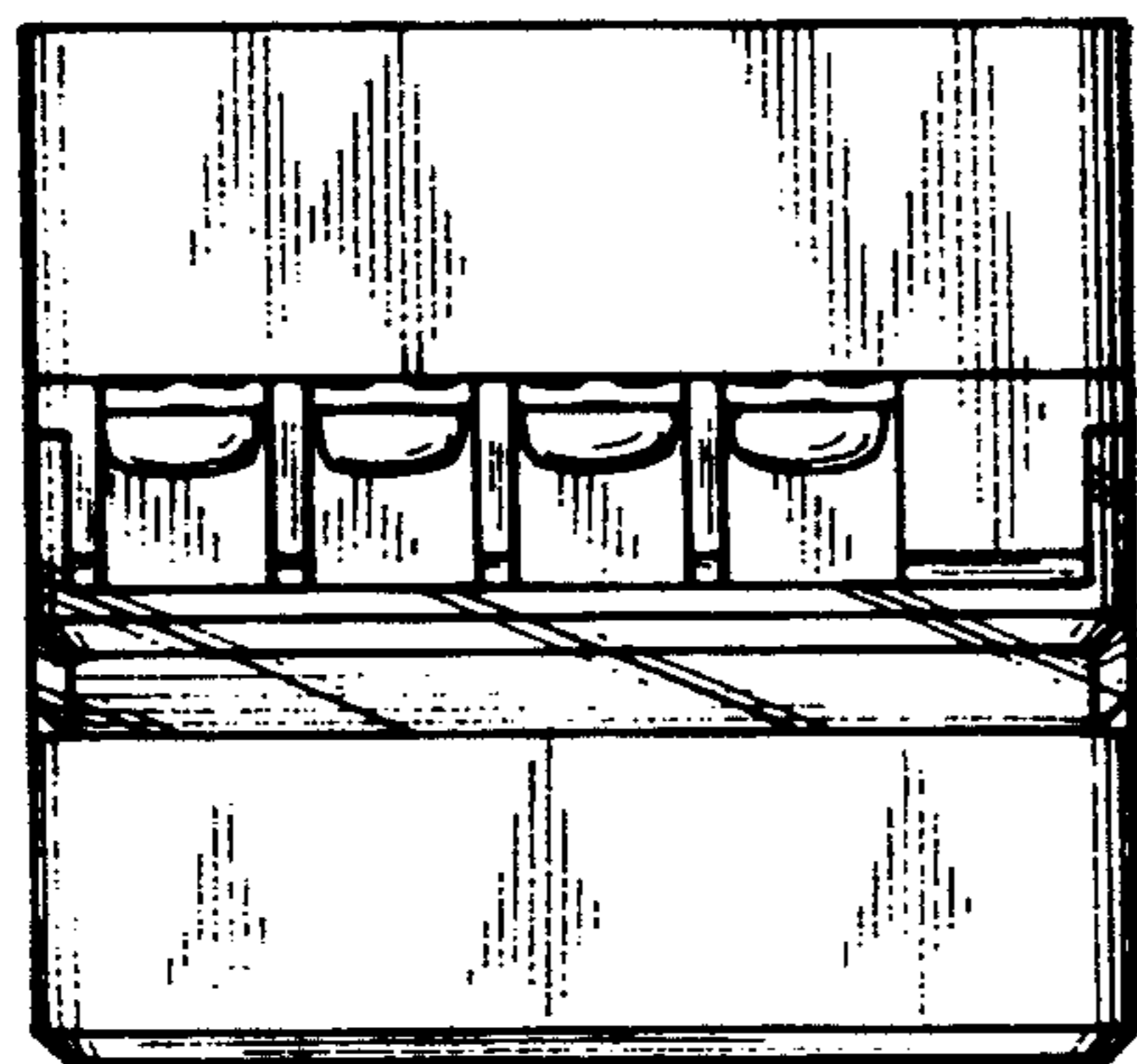

*FIG. 10*

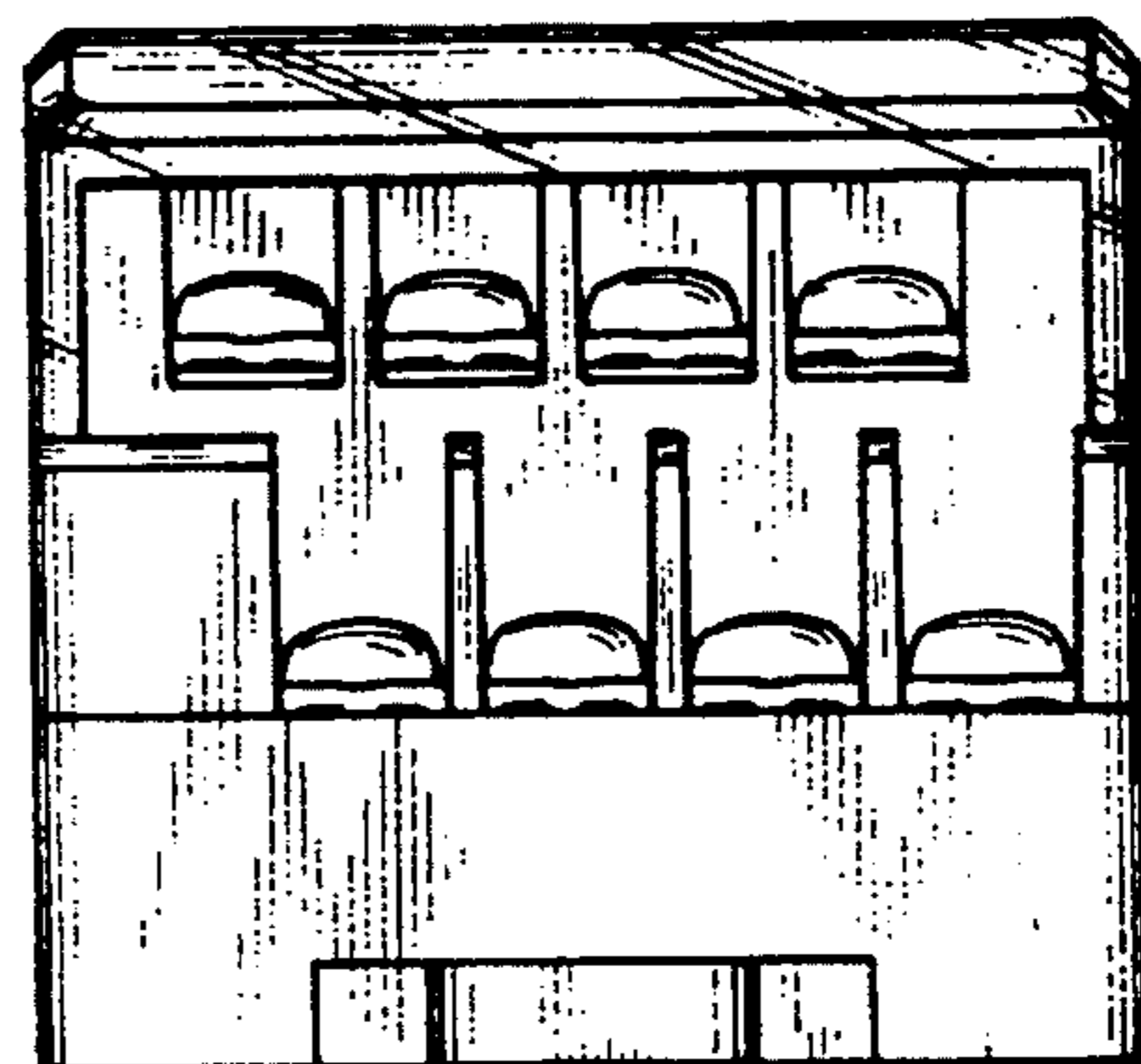



FIG. 11

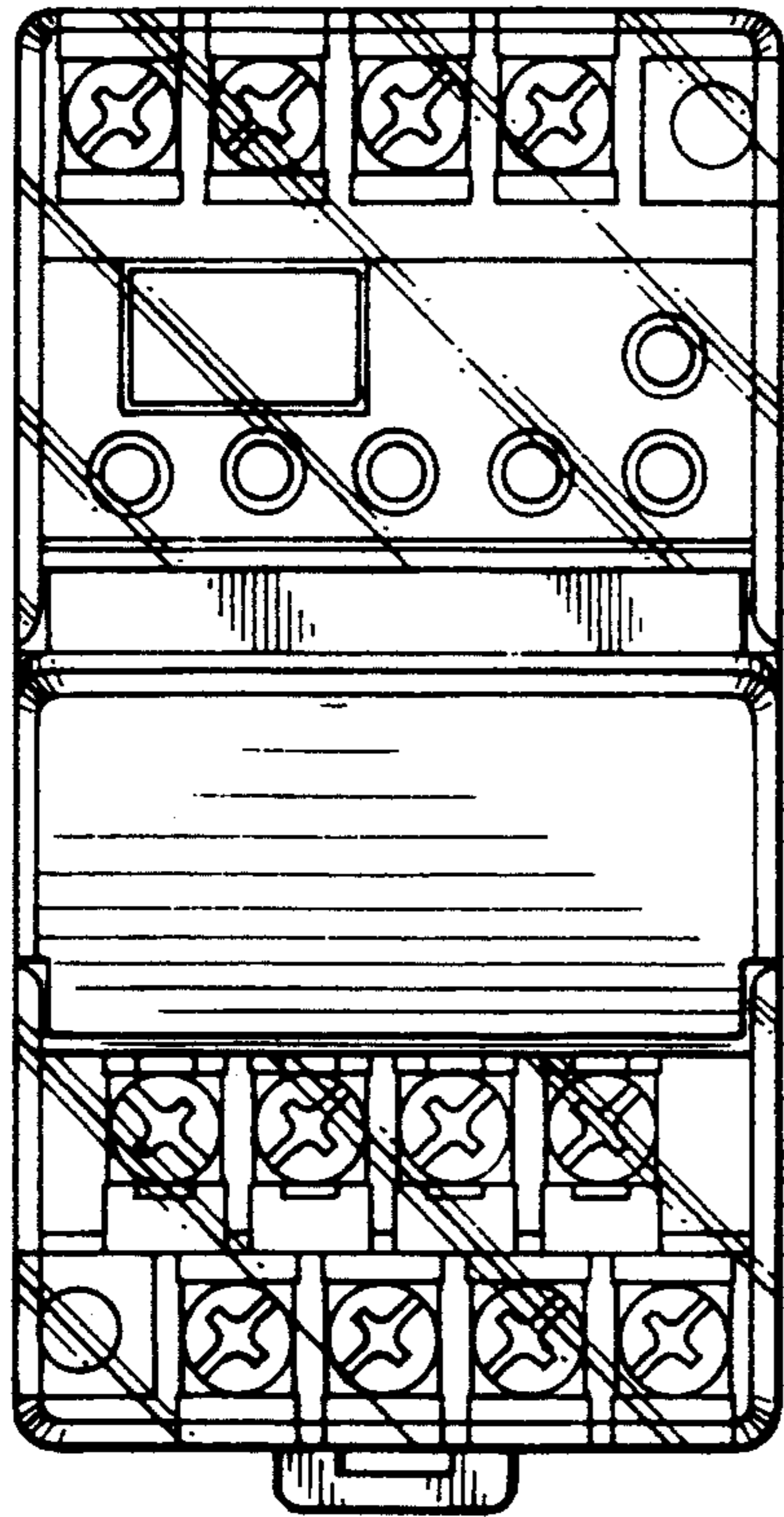

FIG. 12

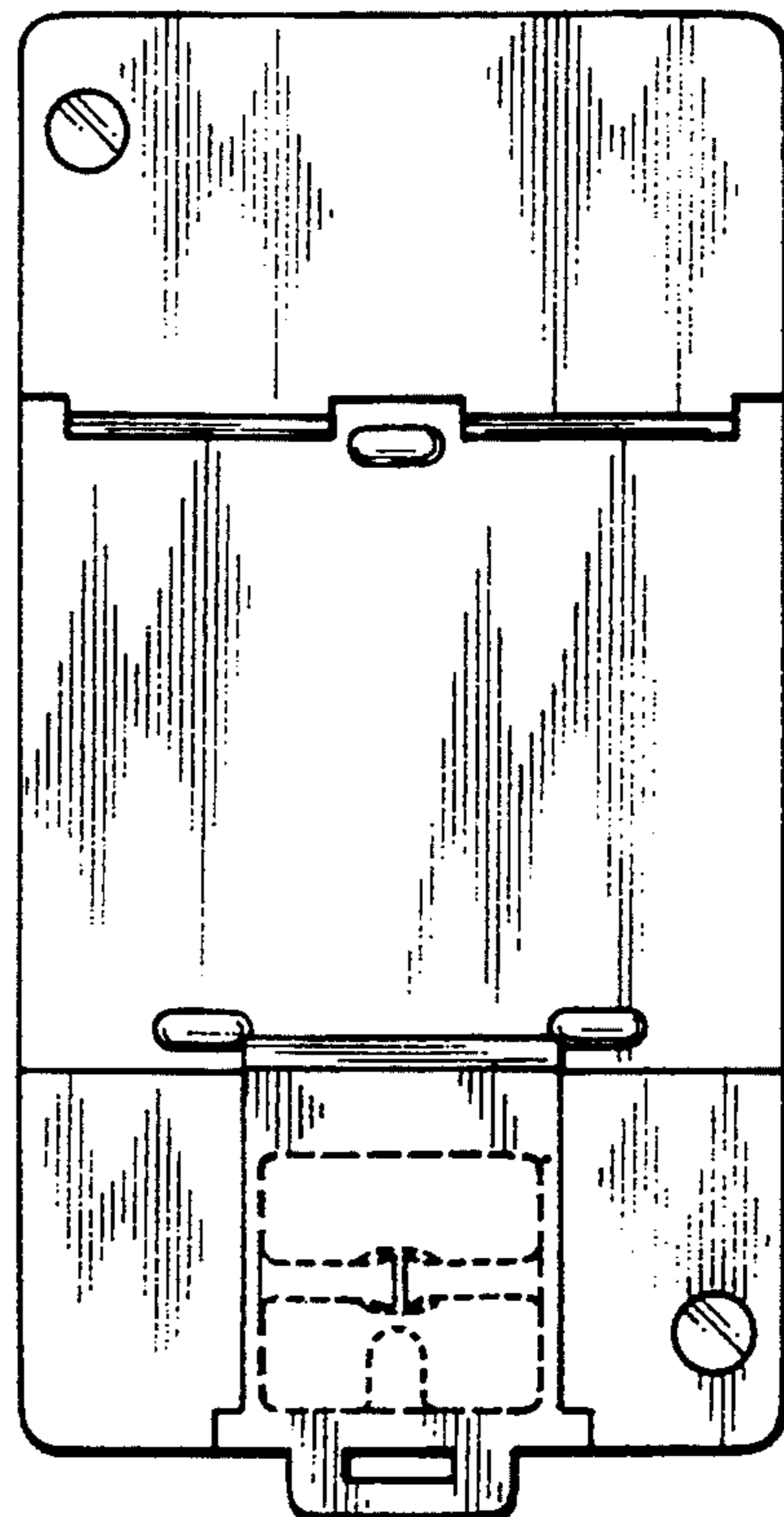

FIG. 13

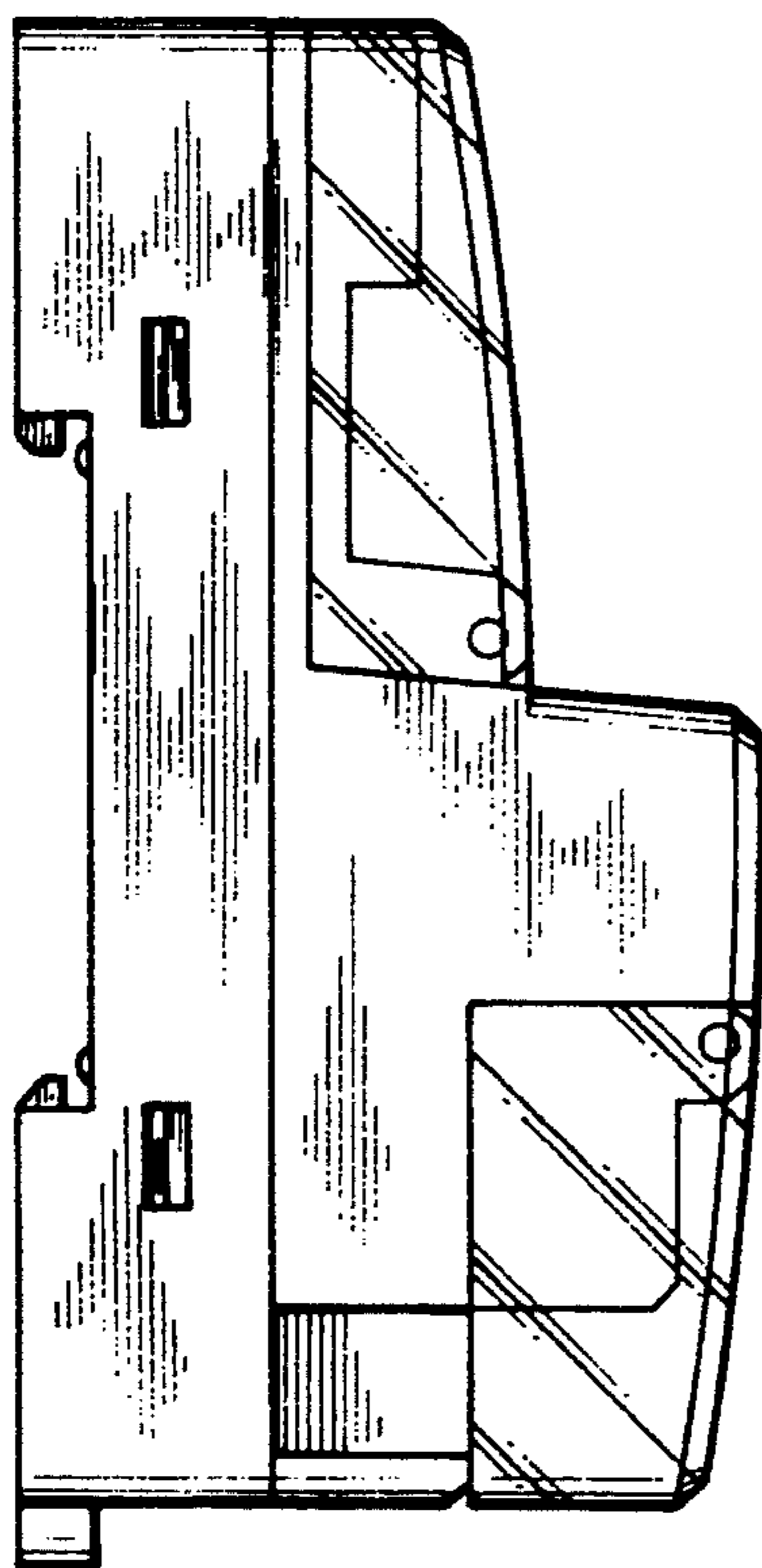

FIG. 14

