



US00D351101S

United States Patent [19]

[11] Patent Number: **Des. 351,101**

Linnér

[45] Date of Patent: **** Oct. 4, 1994**

- [54] TUBE
- [75] Inventor: **Hans Linnér, Kalmar, Sweden**
- [73] Assignee: **Norden Pac Development AB, Sweden**
- [**] Term: **14 Years**
- [21] Appl. No.: **16,705**
- [22] Filed: **Dec. 22, 1993**

Related U.S. Application Data

- [62] Division of Ser. No. 859,141, Mar. 27, 1992, Pat. No. Des. 344,888.

[30] Foreign Application Priority Data

- Jan. 20, 1992 [FR] France 920316
- Feb. 26, 1992 [FR] France 921201

- [52] U.S. Cl. **D9/302**

- [58] Field of Search D9/302, 306, 337; D6/541; 222/92, 96, 107, 209, 181

[56] References Cited

U.S. PATENT DOCUMENTS

- D. 70,517 7/1926 Vaughan .
- D. 99,424 5/1935 de Vaulchier .
- D. 184,020 12/1958 Lerner D9/301
- D. 200,817 4/1965 Woodard D9/302
- D. 201,646 7/1965 Woodard .
- D. 204,426 4/1966 Dalsgaard .
- D. 212,585 11/1968 Joy .
- D. 240,017 5/1976 Trott .
- D. 245,758 9/1977 Pardo .
- D. 246,155 10/1977 Hoyt .
- D. 246,509 11/1977 Hytken D9/302
- D. 267,927 2/1983 Smith .
- D. 278,120 3/1985 Grant et al. .
- D. 279,077 6/1985 Drummond, Jr. et al. .
- D. 279,548 7/1985 Schildknecht D9/307
- D. 288,061 2/1987 Bek et al. D9/302
- D. 292,556 11/1987 Daugherty D9/329
- D. 296,419 6/1988 Terrell D9/302
- D. 308,824 6/1990 Wiseman et al. .
- D. 310,487 9/1990 Genaro .
- D. 311,133 10/1990 Wiseman et al. .
- D. 316,221 4/1991 Dombroski D9/302
- D. 321,127 10/1991 Dombroski D9/302
- D. 321,828 11/1991 Durling .
- D. 323,291 1/1992 Wilgus D9/302 X
- D. 323,984 2/1992 Hamilton et al. .

- D. 324,806 3/1992 Van Arman D9/302
- D. 338,397 8/1993 Sun et al. D9/302
- D. 344,888 3/1994 Linnér D9/302
- 1,919,712 7/1933 Dunlop .
- 1,934,699 11/1939 Christen .
- 2,147,349 2/1939 Piquerez .
- 2,182,243 12/1939 Baker .
- 2,435,251 2/1948 Tome .
- 2,751,072 6/1956 Ditmar .
- 3,306,500 2/1967 Williams D9/302 X
- 3,395,836 8/1968 Stahmer .
- 3,422,997 1/1969 Anderson D9/302 X
- 4,126,249 11/1978 Wood 222/92
- 4,598,839 7/1986 Dombroski et al. 222/92
- 4,709,821 12/1987 Guiffroy 215/1 R
- 4,997,107 3/1991 Snyder et al. 222/92

OTHER PUBLICATIONS

Modern Packaging; Nov. 1976; p. 8.

Primary Examiner—Bernard Ansher

Assistant Examiner—M. Siegel

Attorney, Agent, or Firm—Lerner, David, Littenberg, Krumholz & Mentlik

[57] CLAIM

The ornamental design for a tube, as shown and described.

DESCRIPTION

FIG. 1 is a top plan view of a tube showing my new design, the opposite side being identical;
 FIG. 2 is a side elevational view thereof, the opposite side being identical;
 FIG. 3 is a perspective view thereof;
 FIG. 4 is a top plan view of a second embodiment of a tube as in FIG. 1, the opposite side being identical;
 FIG. 5 is a side elevational view of FIG. 4, the opposite side being identical;
 FIG. 6 is a perspective view of FIG. 4;
 FIG. 7 is a top plan view of a third embodiment of a tube as in FIG. 1, the opposite side being identical;
 FIG. 8 is a side elevational view of FIG. 7, the opposite side being identical;
 FIG. 9 is a perspective view of FIG. 7;
 FIG. 10 is a top plan view of a fourth embodiment of a tube as in FIG. 1, the opposite side being identical;
 FIG. 11 is a side elevational view of FIG. 10, the opposite side being identical; and,
 FIG. 12 is a perspective view of FIG. 10.

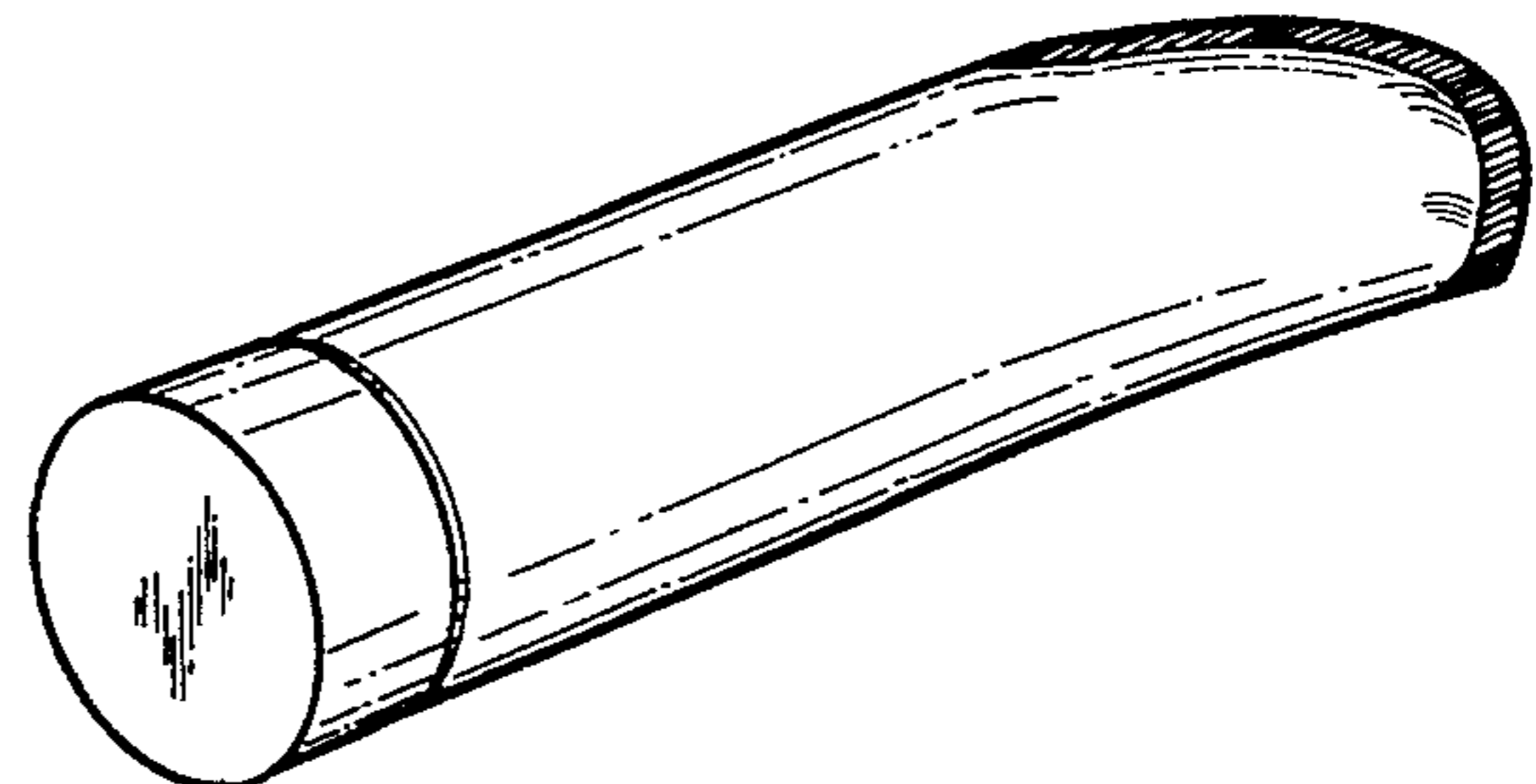
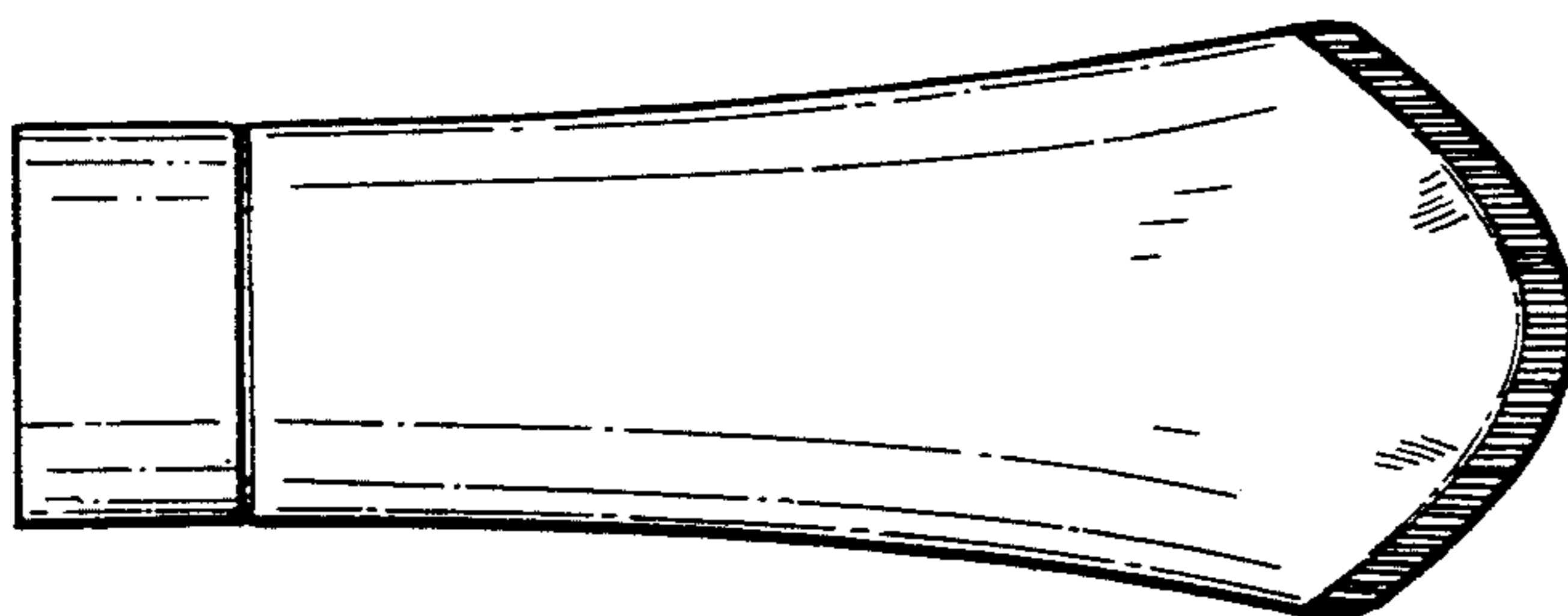

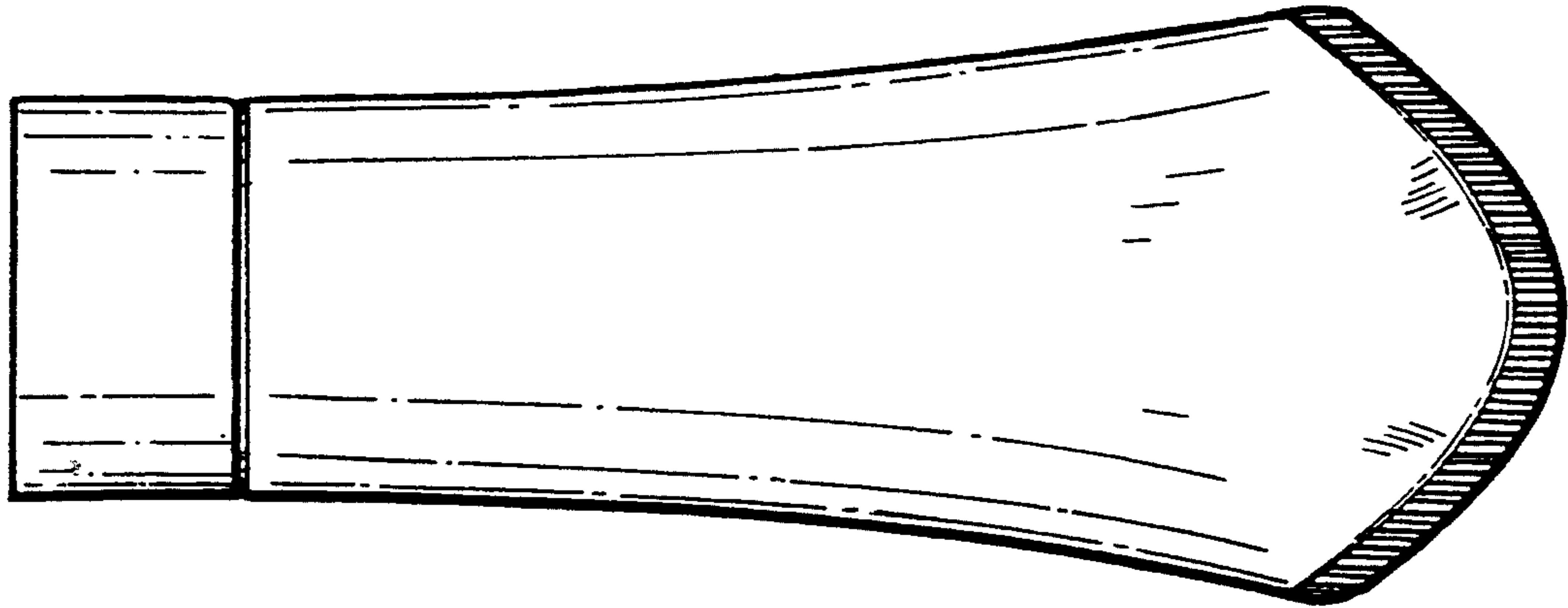

FIG. 1

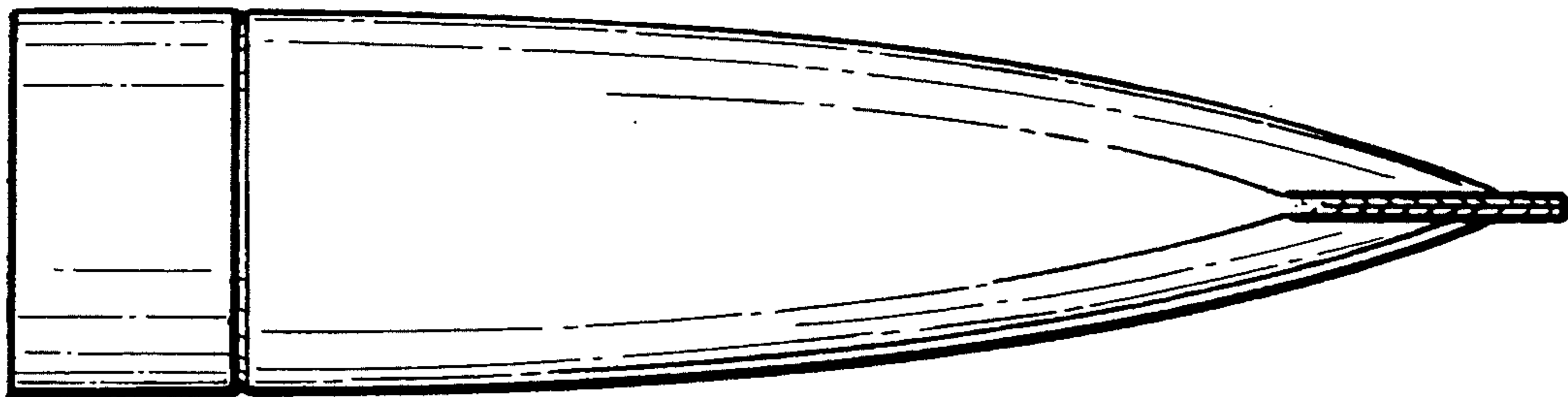

FIG. 2

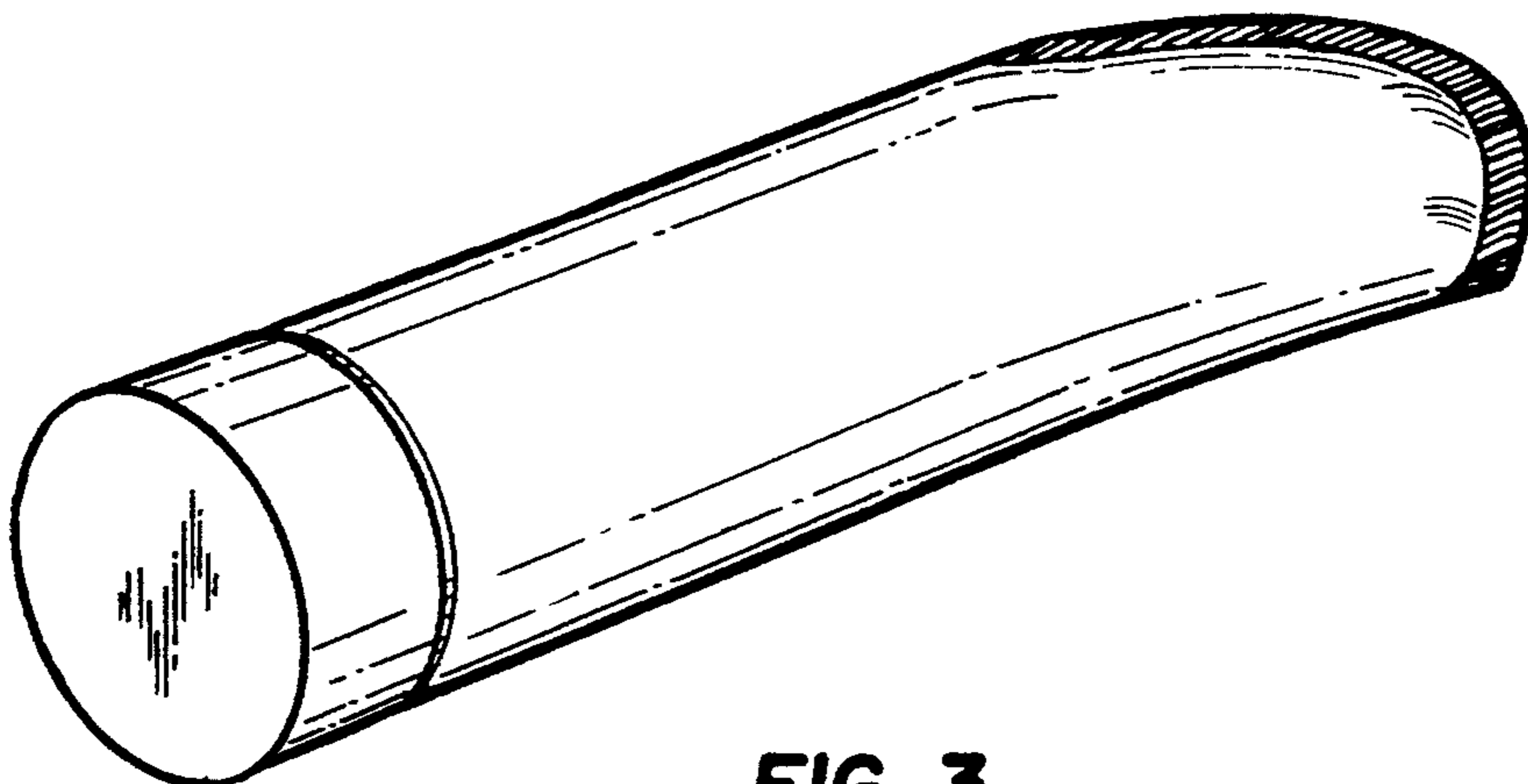

FIG. 3

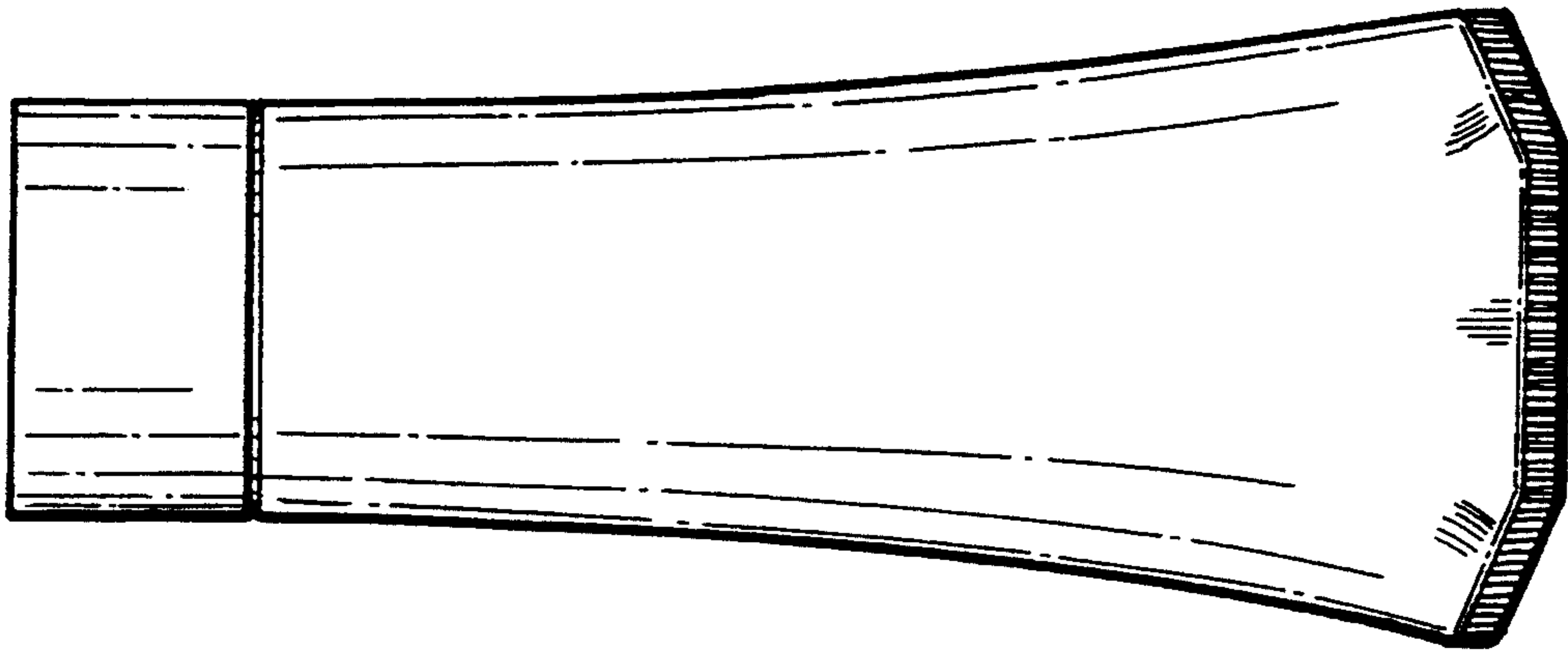

FIG. 4

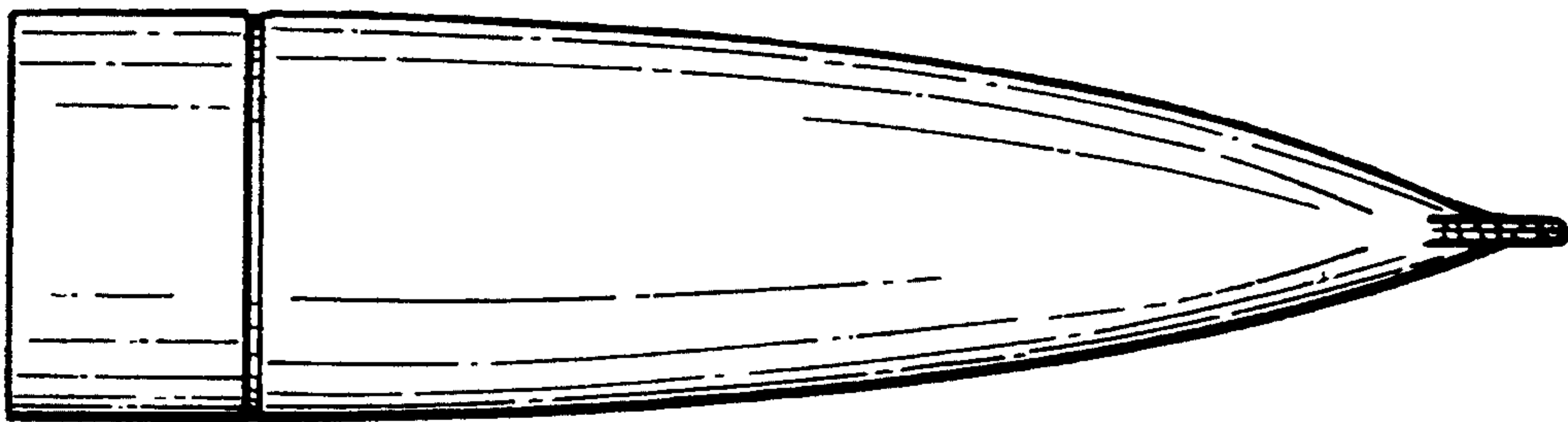

FIG. 5

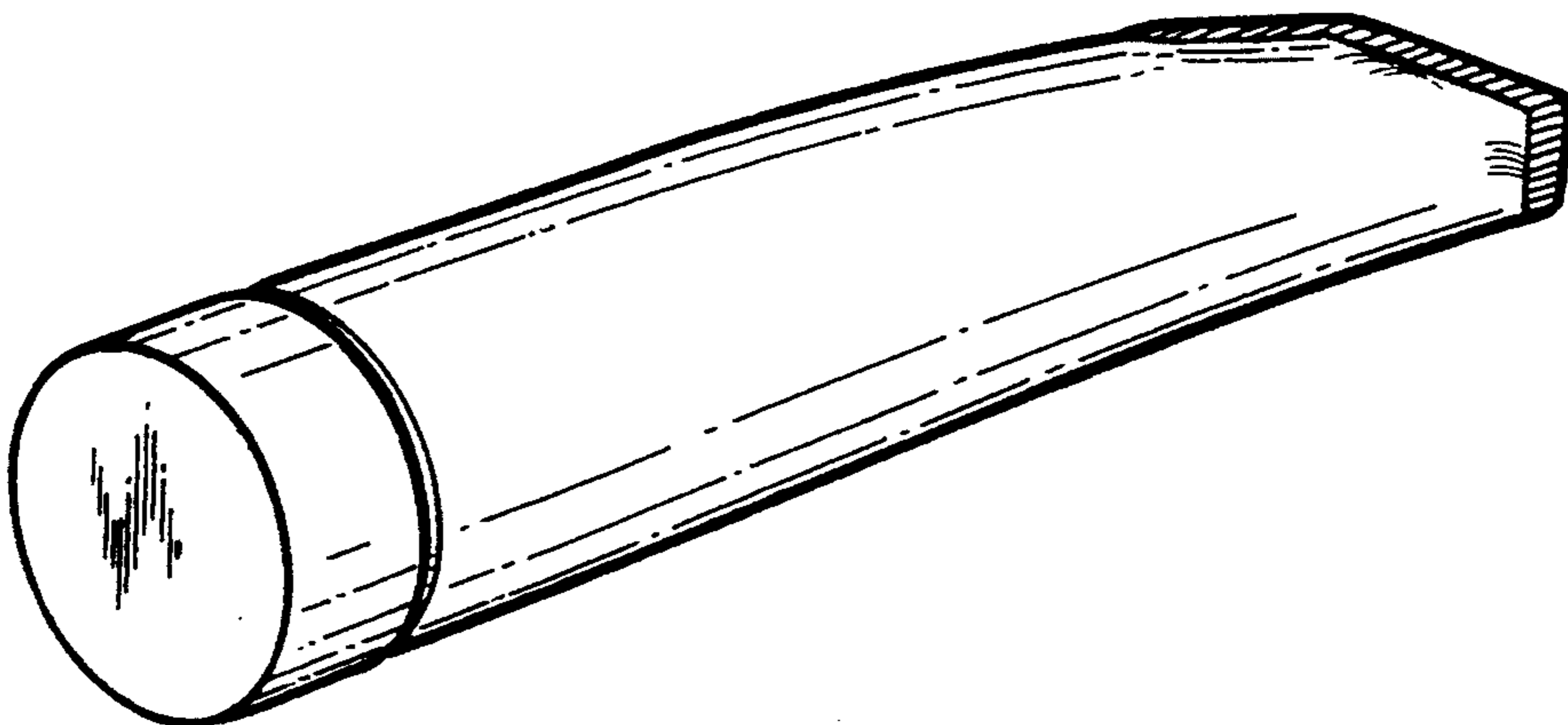

FIG. 6

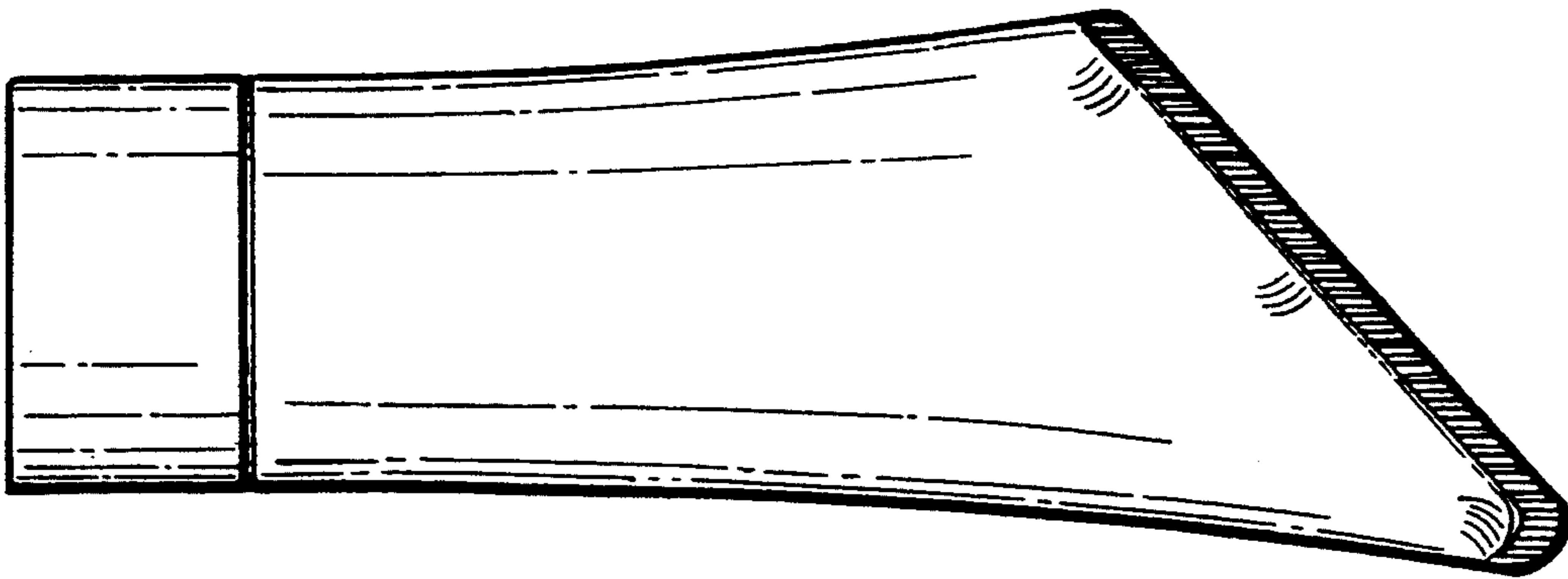

FIG. 7

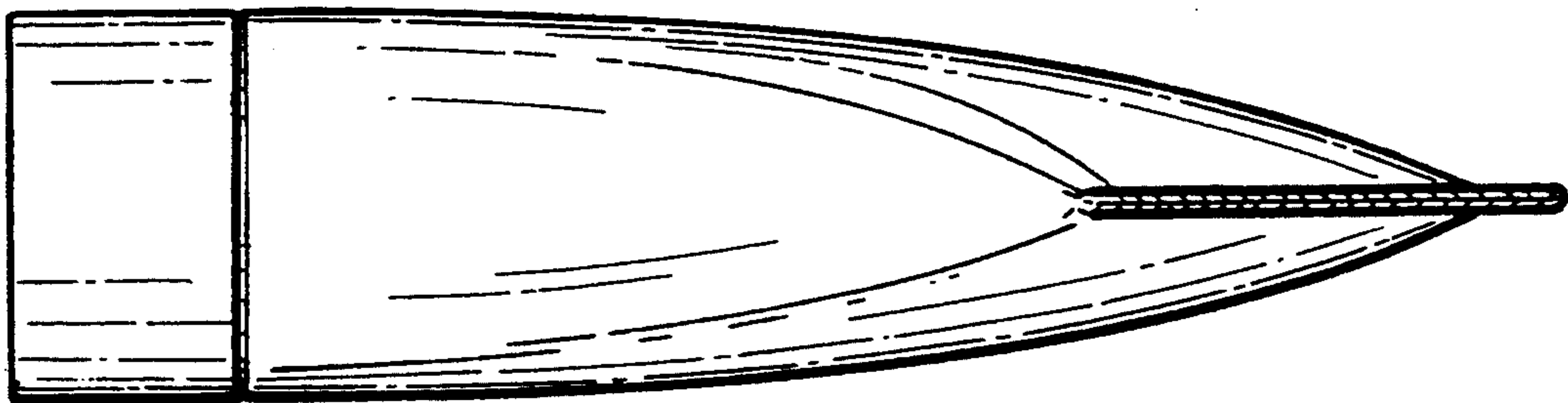

FIG. 8

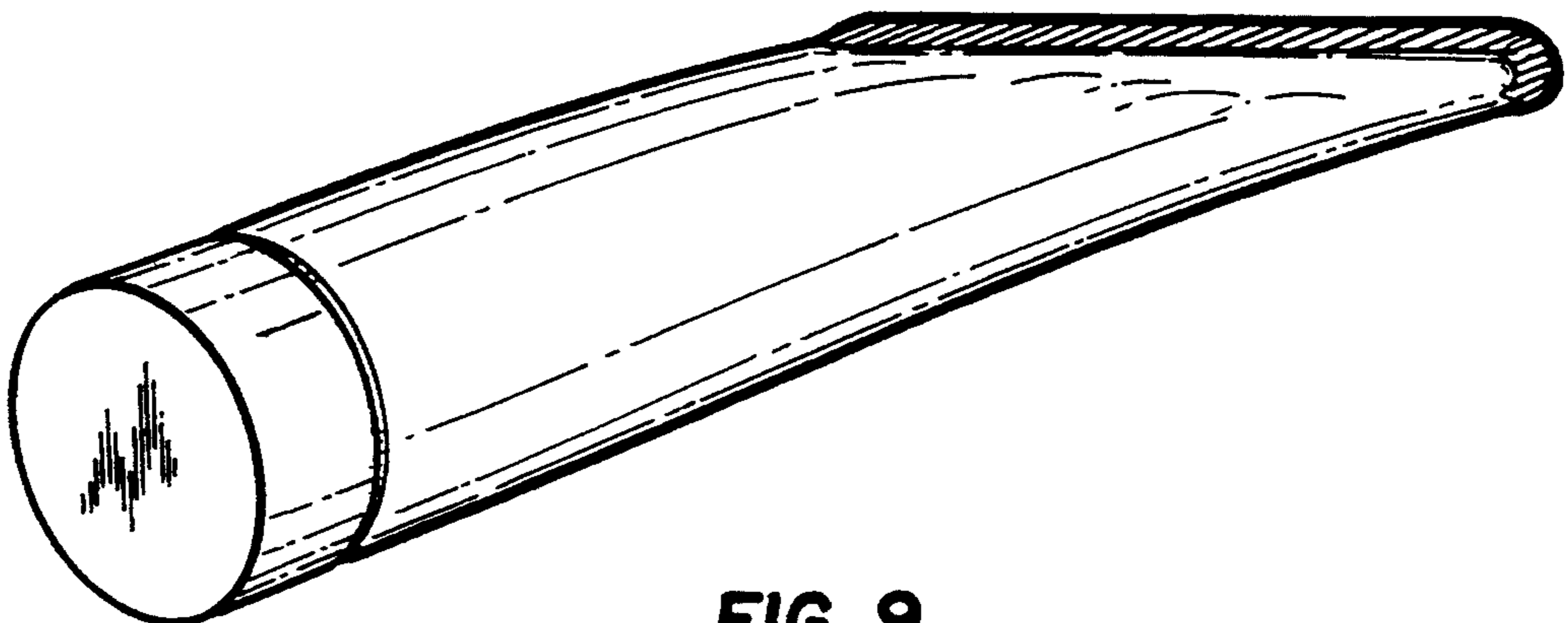

FIG. 9

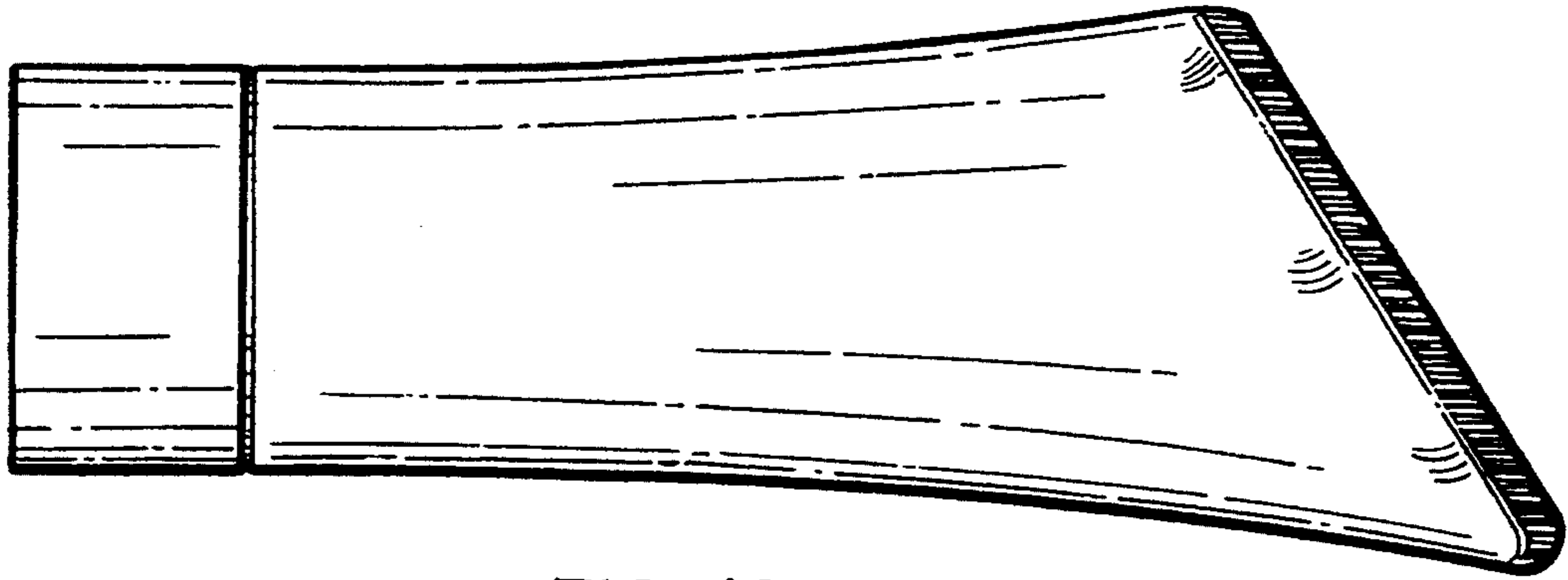

FIG. 10

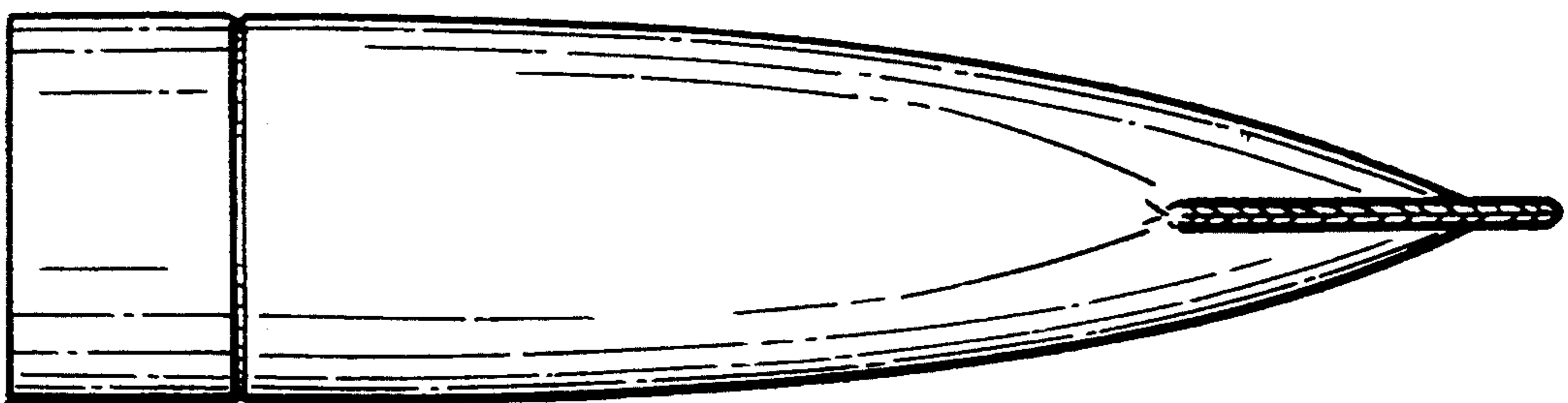

FIG. 11

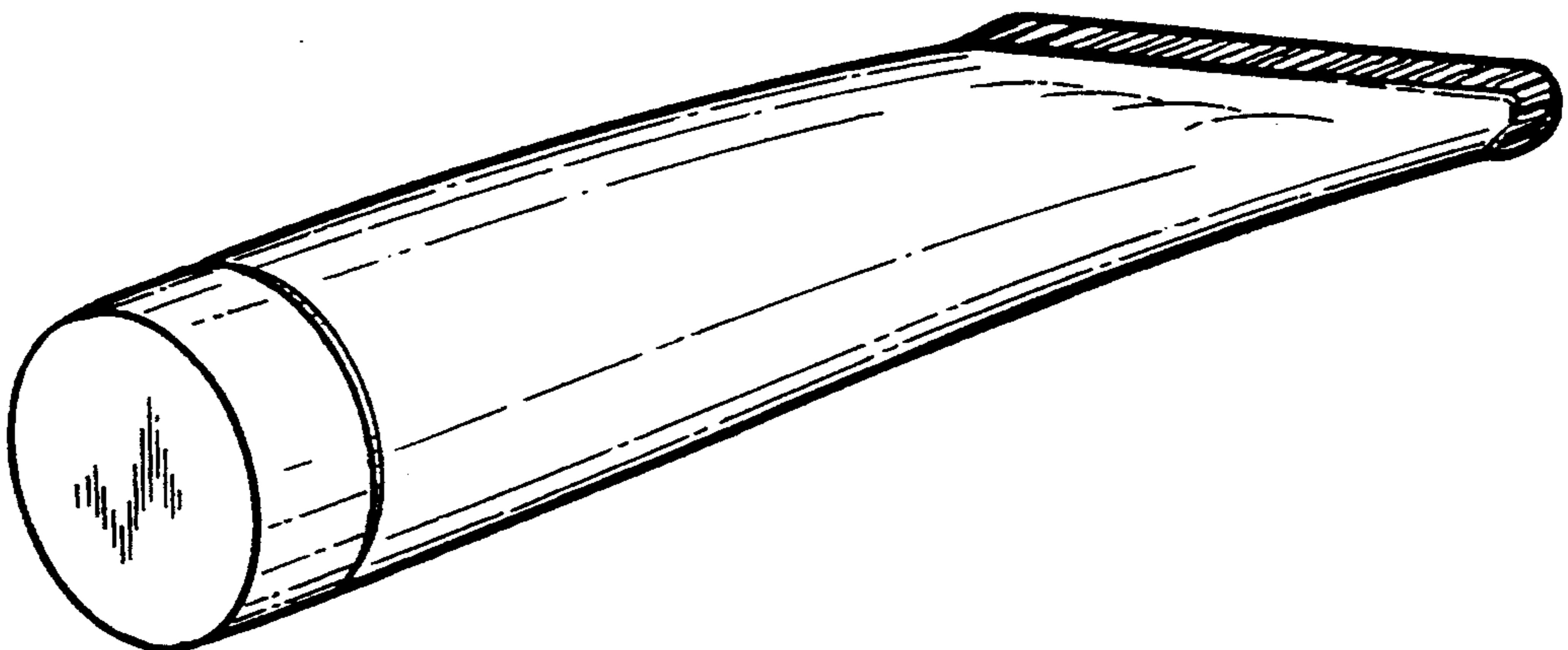

FIG. 12