



US00D351087S

United States Patent [19]

[11] Patent Number: **Des. 351,087**

Anderson

[45] Date of Patent: **** Oct. 4, 1994**

- [54] **FOOD TRAY WITH COVER**
- [75] Inventor: **John W. Anderson**, Springfield, Mass.
- [73] Assignee: **Temp-Tech Co. Inc.**, Springfield, Mass.
- [**] Term: **14 Years**
- [21] Appl. No.: **4,001**
- [22] Filed: **Jan. 22, 1993**
- [52] U.S. Cl. **D7/541; D7/550; D7/553**
- [58] **Field of Search** **D7/550, 551, 552, 553, D7/554, 555, 556, 557, 538, 601, 602, 507, 354, 359, 360, 541; D6/406; 220/339, 575; 108/25; D9/341, 347, 423, 431, 425; 221/2.5 R; D19/76, 92**

- 4,545,487 10/1985 Asmus D9/341 X
- 4,574,174 3/1986 McGonigle D7/541 X

Primary Examiner—Alan P. Douglas
Assistant Examiner—Marianne N. Pandozzi
Attorney, Agent, or Firm—Fishman, Dionne & Cantor

[57] CLAIM

The ornamental design for a food tray with cover, as shown.

DESCRIPTION

FIG. 1 is a top plan view of a food tray with cover showing my new design;
 FIG. 2 front elevation view of the food tray with cover shown in FIG. 1;
 FIG. 3 is a section view taken along the line 3—3 of the food tray with cover shown in FIG. 1; and
 FIG. 4 is a section view taken along the line 4—4 of the food tray with cover shown in FIG. 1;
 FIG. 5 is a right side view of the food tray with cover shown in FIG. 1;
 FIG. 6 is a left side view of the food tray with cover shown in FIG. 1;
 FIG. 7 is a section view taken along the line 7—7 of the food tray with cover shown in FIG. 1;
 FIG. 8 is a bottom plan view of the food tray with cover shown in FIG. 1; and,
 FIG. 9 is a rear elevation view of the food tray with cover shown in FIG. 1.

[56] References Cited

U.S. PATENT DOCUMENTS

- | | | | | |
|------------|---------|----------|-------|----------|
| D. 132,425 | 5/1942 | Erickson | | D7/553 |
| D. 256,872 | 9/1980 | Otto | | D7/541 |
| D. 261,589 | 11/1981 | Herbst | | D9/347 X |
| D. 267,767 | 2/1983 | Storrs | | D7/553 |
| D. 338,808 | 8/1993 | Anderson | | D7/553 |
| 1,926,481 | 9/1933 | Fox | | D7/354 X |
| 3,113,710 | 12/1963 | Meagher | | D7/553 X |
| 3,381,876 | 5/1968 | Biggins | | D7/555 X |
| 3,542,280 | 11/1970 | Crabtree | | D7/554 X |

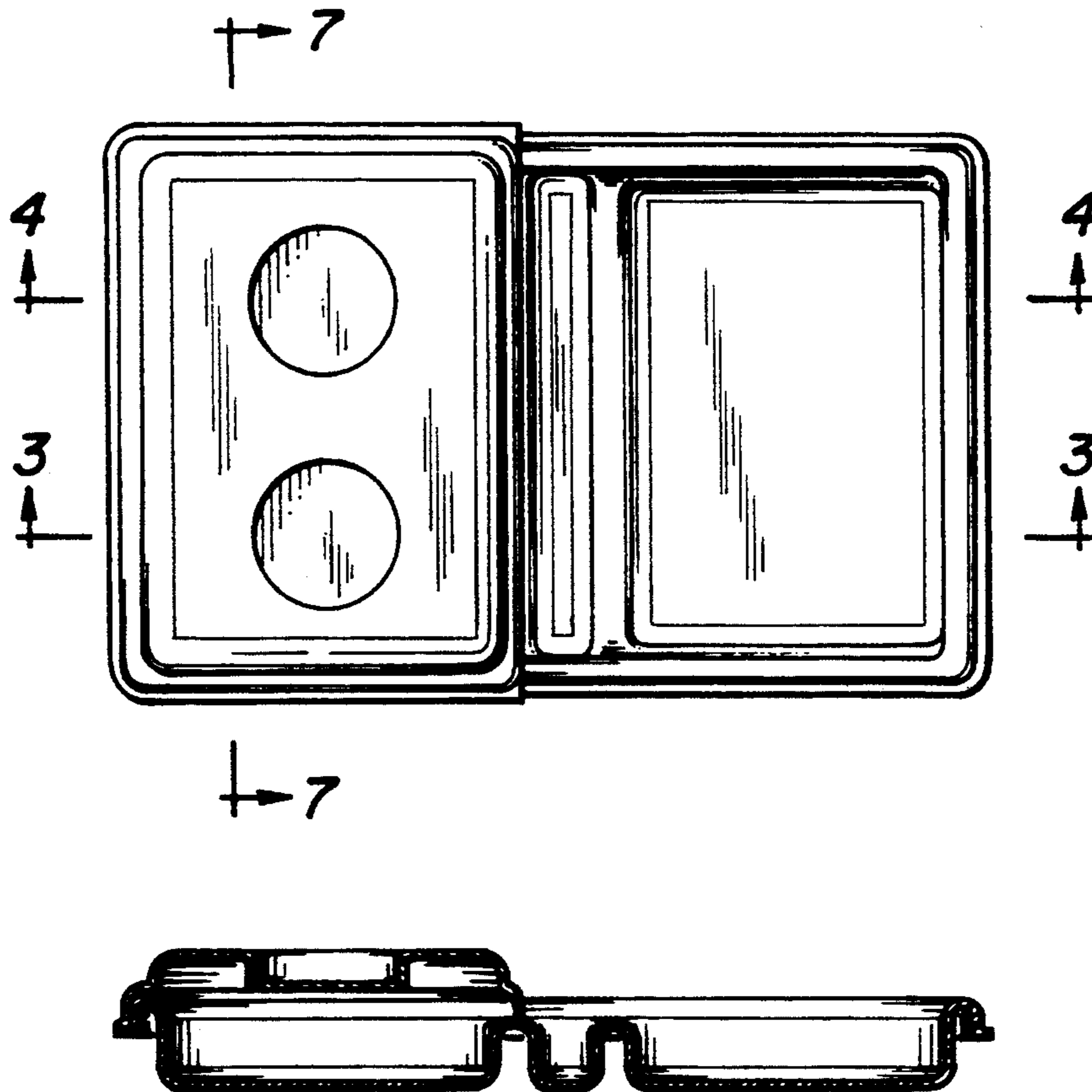

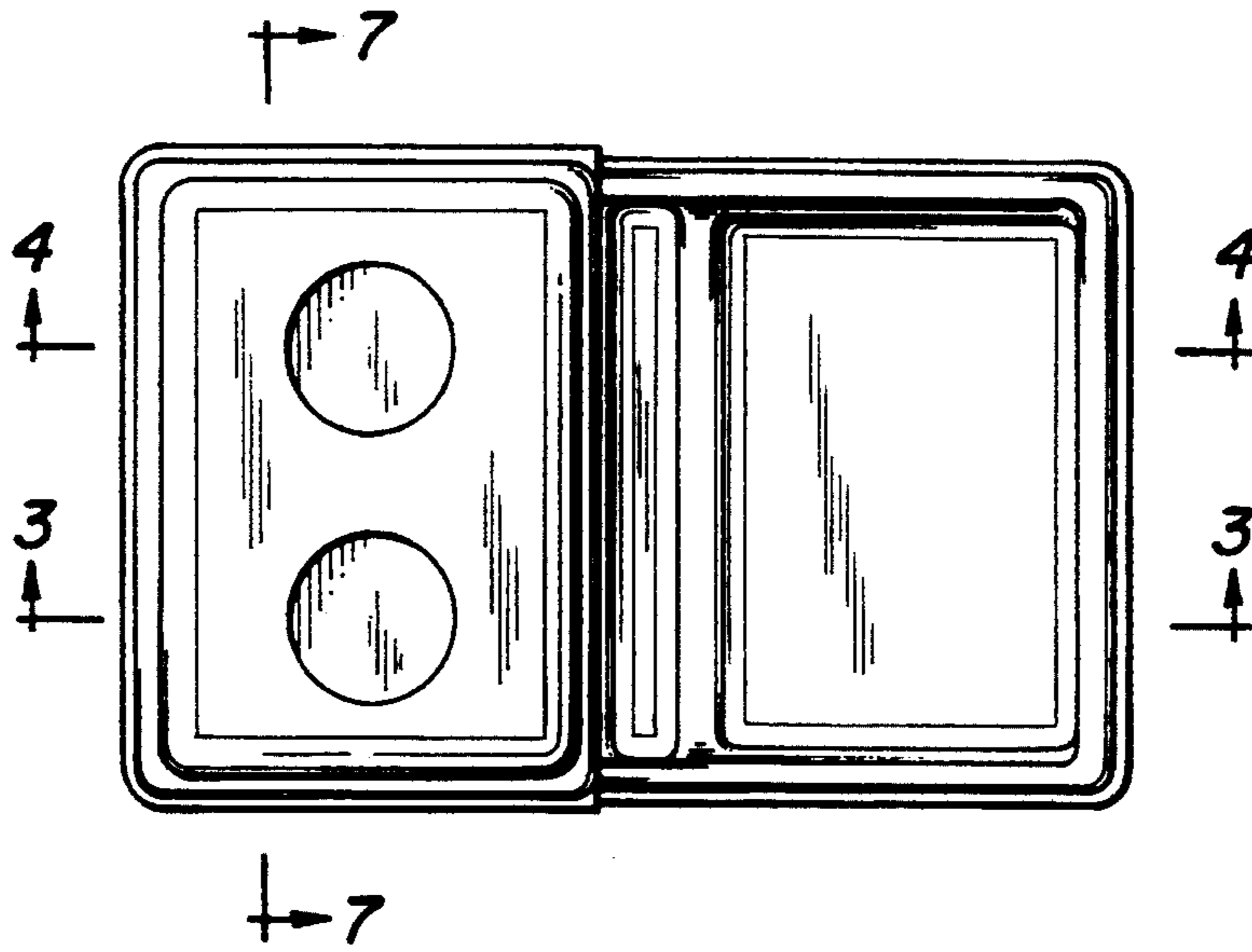

FIG. 1



FIG. 5

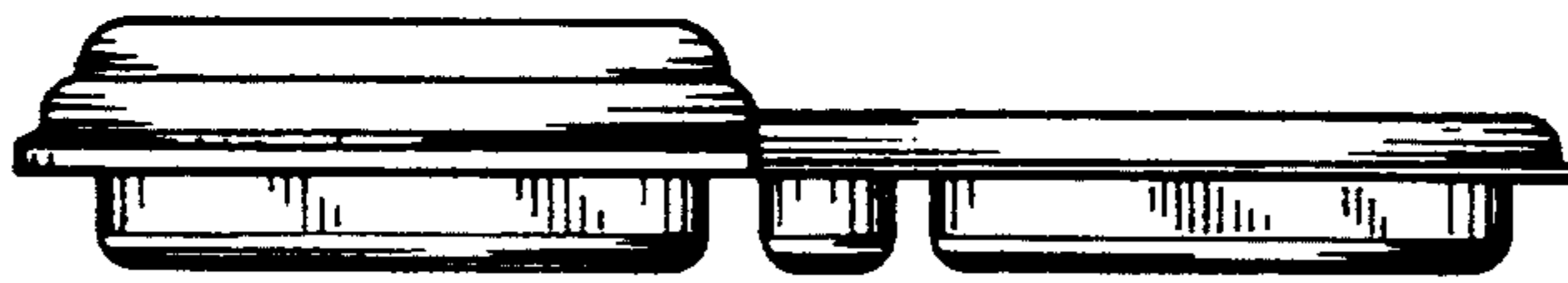

FIG. 2

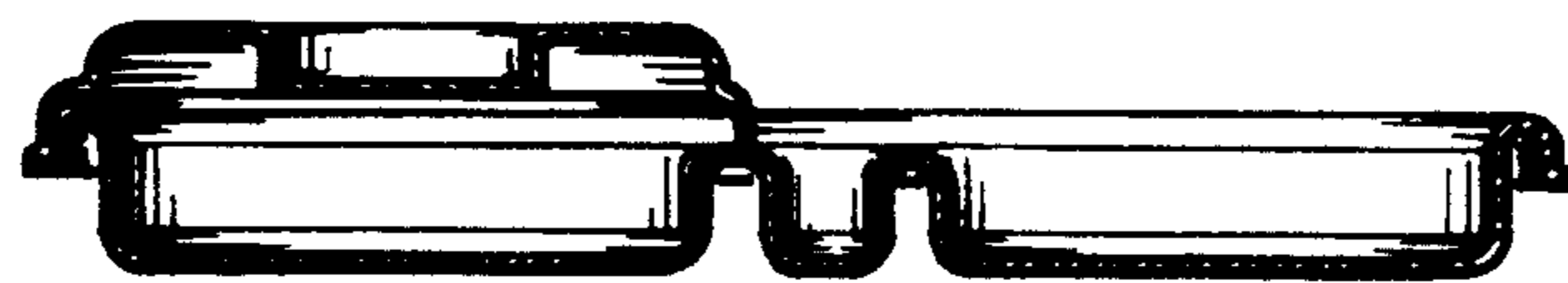

FIG. 3

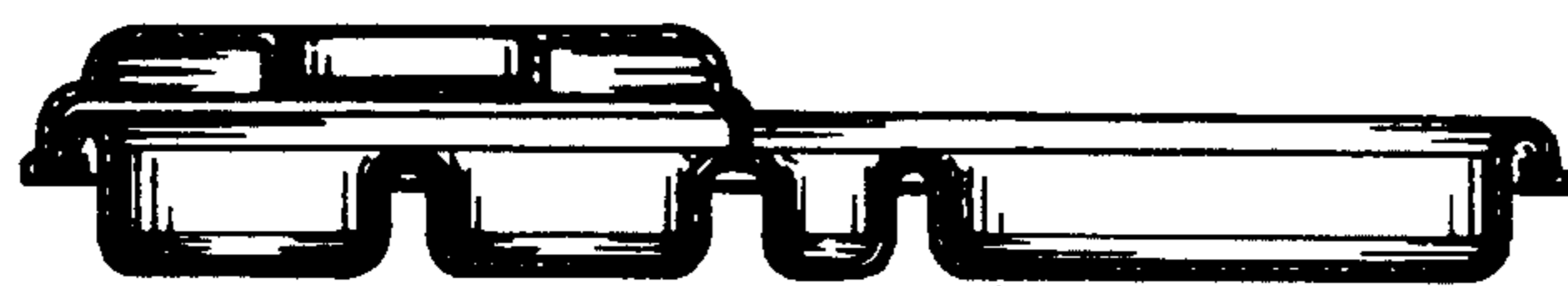

FIG. 4



FIG. 6

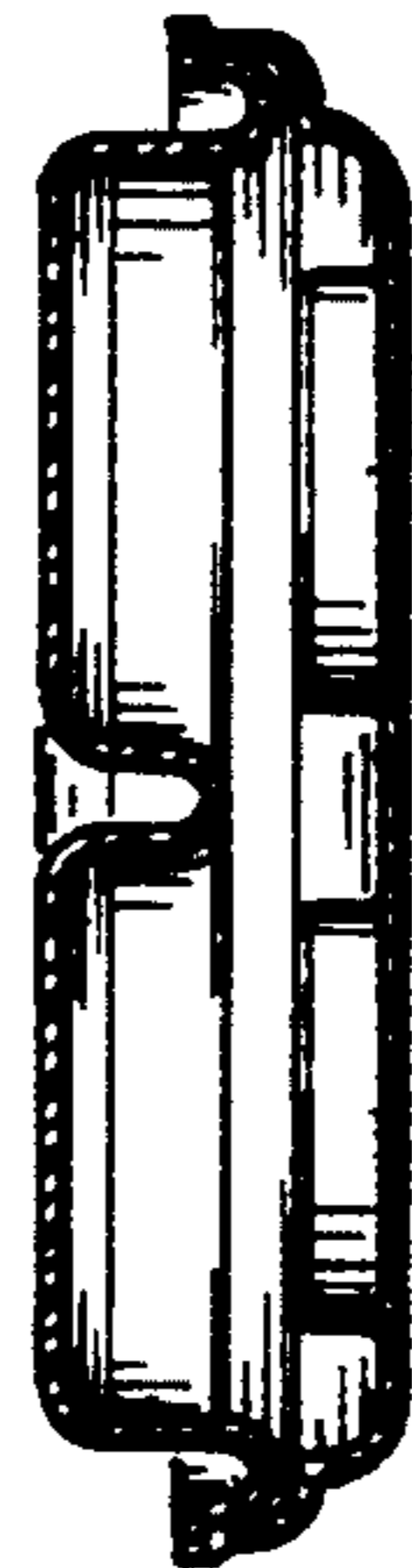

FIG. 7

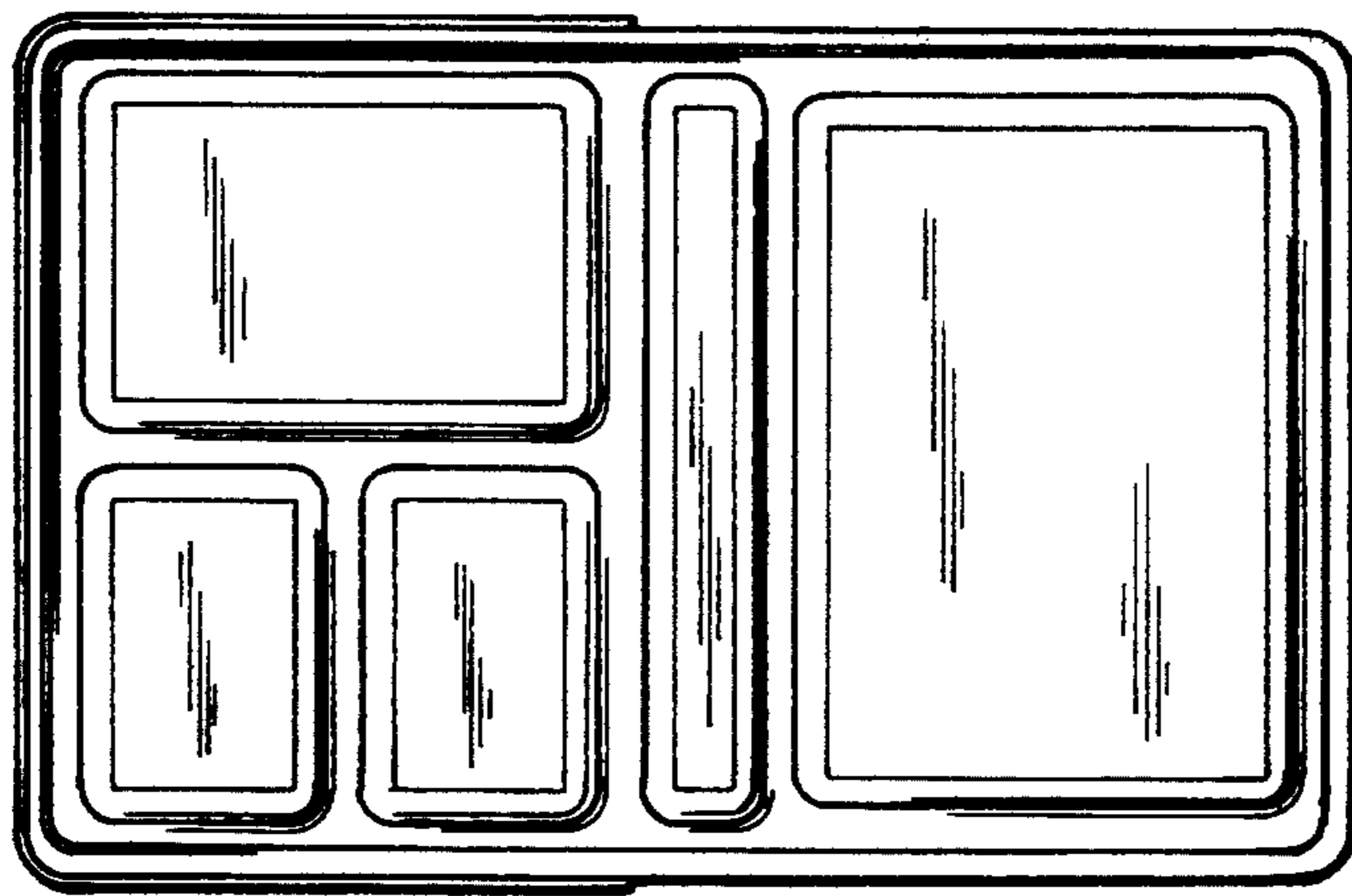

FIG. 8

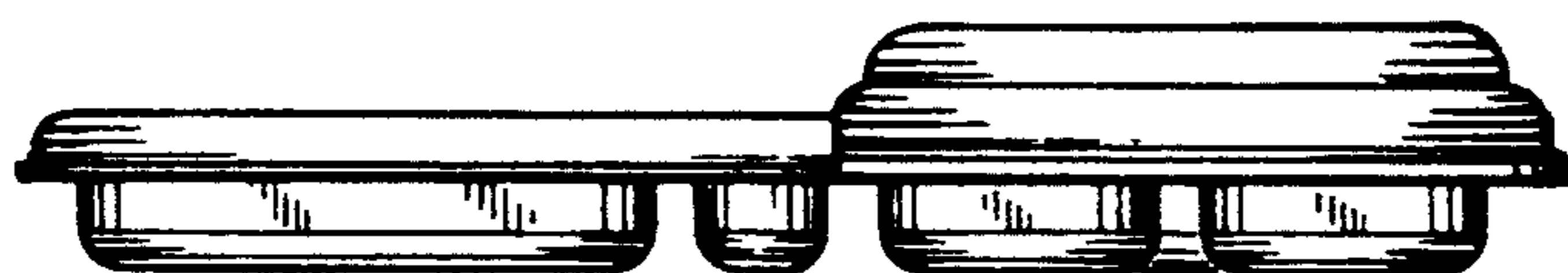

FIG. 9