



US00D351048S

United States Patent [19]

[11] Patent Number: **Des. 351,048**

Gaynor

[45] Date of Patent: **** Sep. 27, 1994**

[54] MANICURIST SUPPLY STAND

[75] Inventor: **Lawrence D. Gaynor**, West Bloomfield, Mich.

[73] Assignee: **Nailco, Inc.**, Livonia, Mich.

[**] Term: **14 Years**

[21] Appl. No.: **1,756**

[22] Filed: **Nov. 23, 1992**

[52] U.S. Cl. **D28/61; D3/313; D3/901; D6/476; D19/85**

[58] Field of Search **D6/476, 510, 420; D7/555; 220/507, 553, 555, 575; D3/310, 313, 901; D28/61, 62, 76, 77; D19/85**

[56] References Cited

U.S. PATENT DOCUMENTS

D. 69,338	1/1926	Weigel .	
D. 208,376	8/1967	De Caccia .	
D. 252,409	7/1979	Rose et al.	D3/901 X
D. 285,993	10/1986	Genna	D6/476 X
D. 286,834	11/1986	Wilken	D3/313 X
D. 287,417	12/1986	Mocek	D28/76
D. 290,534	6/1987	Wendkos .	
D. 295,796	5/1988	Wadsworth et al. .	
D. 297,084	8/1988	Silver	D6/476
D. 298,865	12/1988	Sussman .	
D. 311,785	10/1990	Gaynor .	

OTHER PUBLICATIONS

Pat Harris, Inc. Catalogue, ©1978, "Cosmetic Organizer".

Glynco Plastics, Inc. p. 33. "Plastic Modular Organizer with Dividers".

J. D. Acrylics, p. 14, from "Lucite Box", Easels.

Hong Kong Enterprise, Jun. 1991, p. 408, (G.A.U. 2902), "Cosmetic Organizers".

"Retailing Home Furnishing", Jul. 11, 1983, Section 2, p. 36.

Primary Examiner—B. J. Bullock

Assistant Examiner—Cheri Cohen

Attorney, Agent, or Firm—Dykema Gossett PLLC

[57] CLAIM

The ornamental design for a manicurist supply stand, as shown and described.

DESCRIPTION

FIG. 1 is a front perspective view of a manicurist supply stand showing my new design;

FIG. 2 is a back elevational view thereof;

FIG. 3 is a left-side elevational view of a manicurist supply stand shown in FIG. 1, the right-side being a mirror image.

FIG. 4 is a view along lines 4—4 of the manicurist supply stand shown in FIG. 3;

FIG. 5 is a front elevational view of the manicurist supply stand shown in FIG. 1; and,

FIG. 6 is a bottom plan view of the manicurist supply stand of FIG. 1.

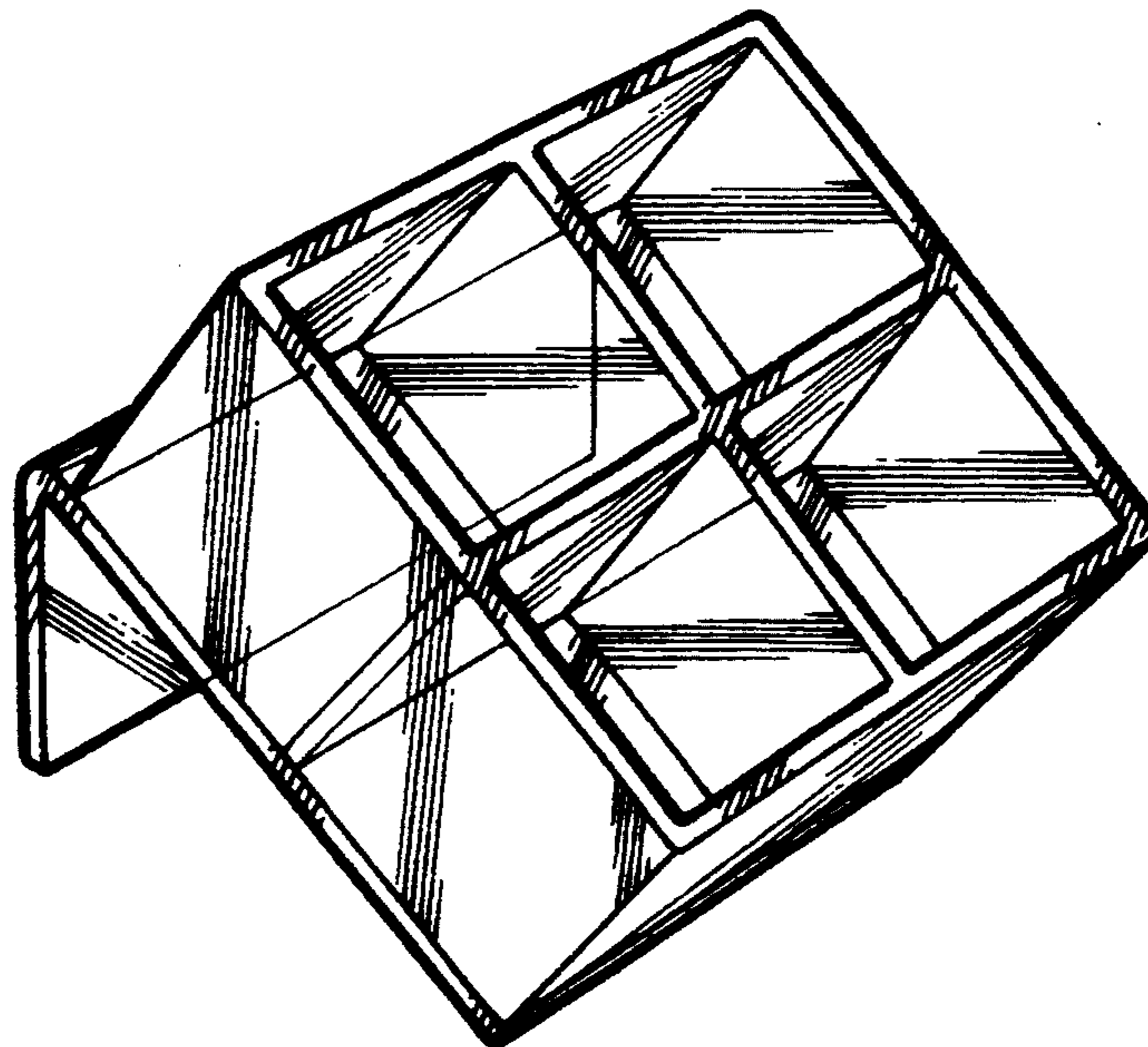

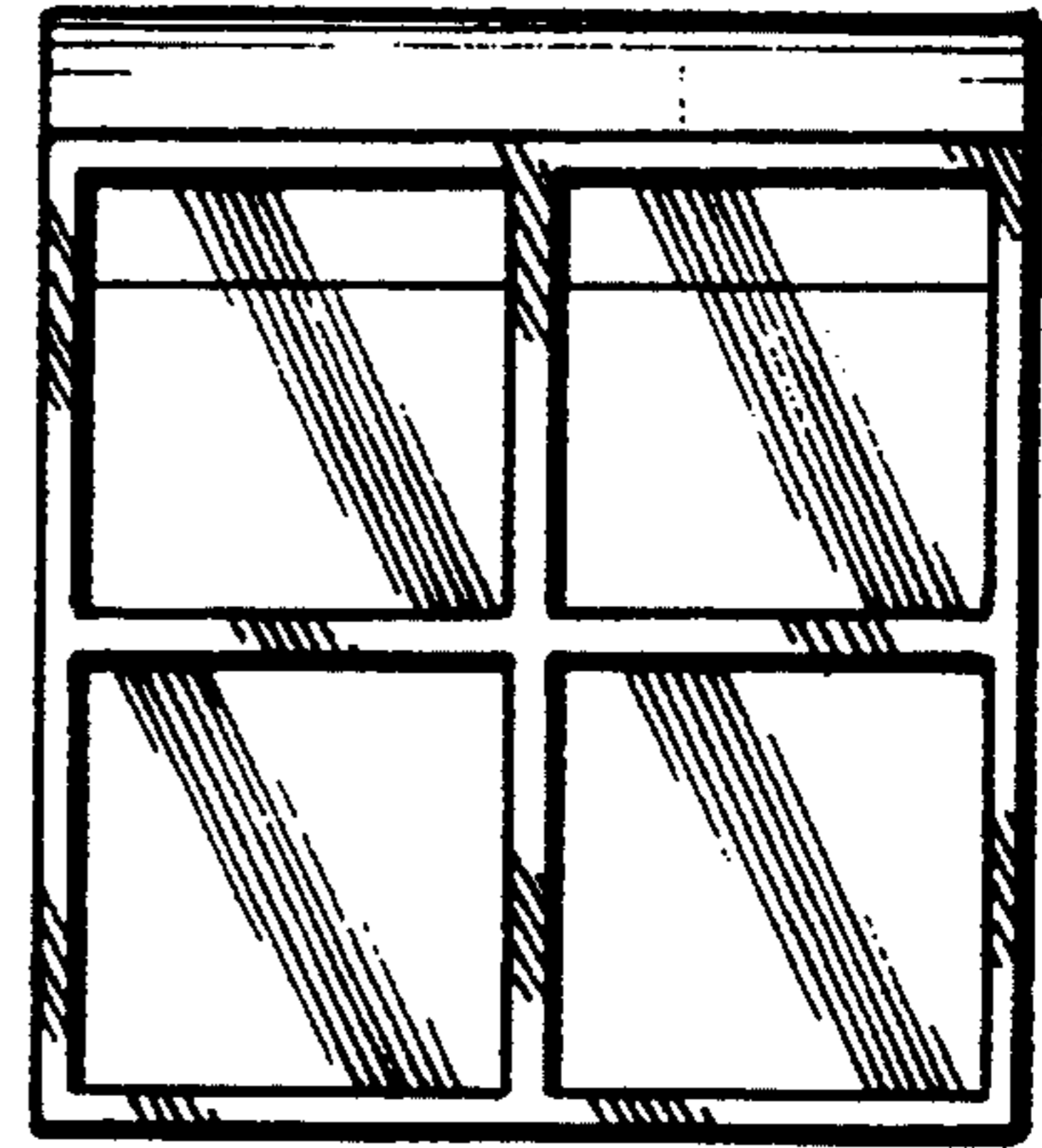
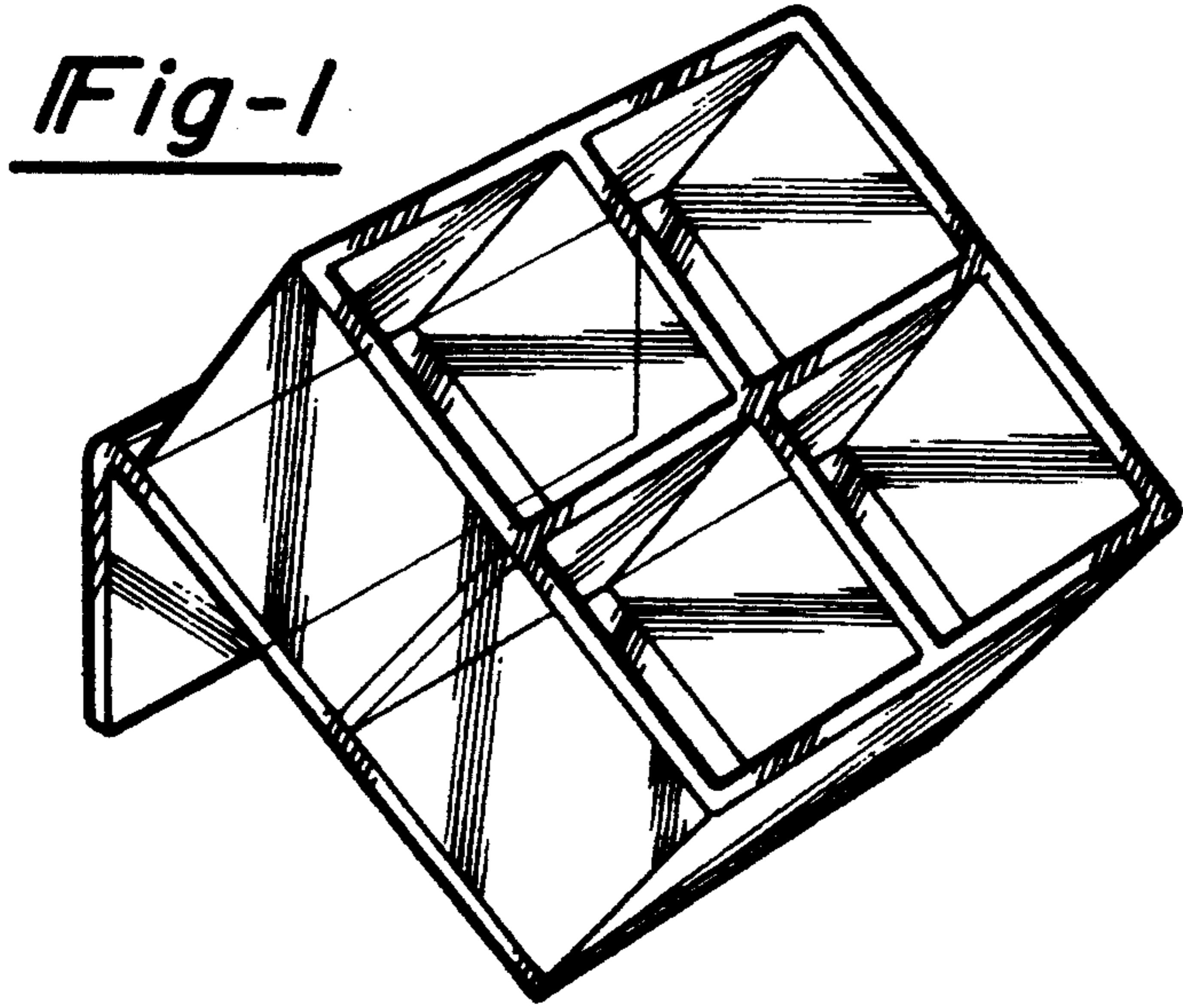

Fig-4

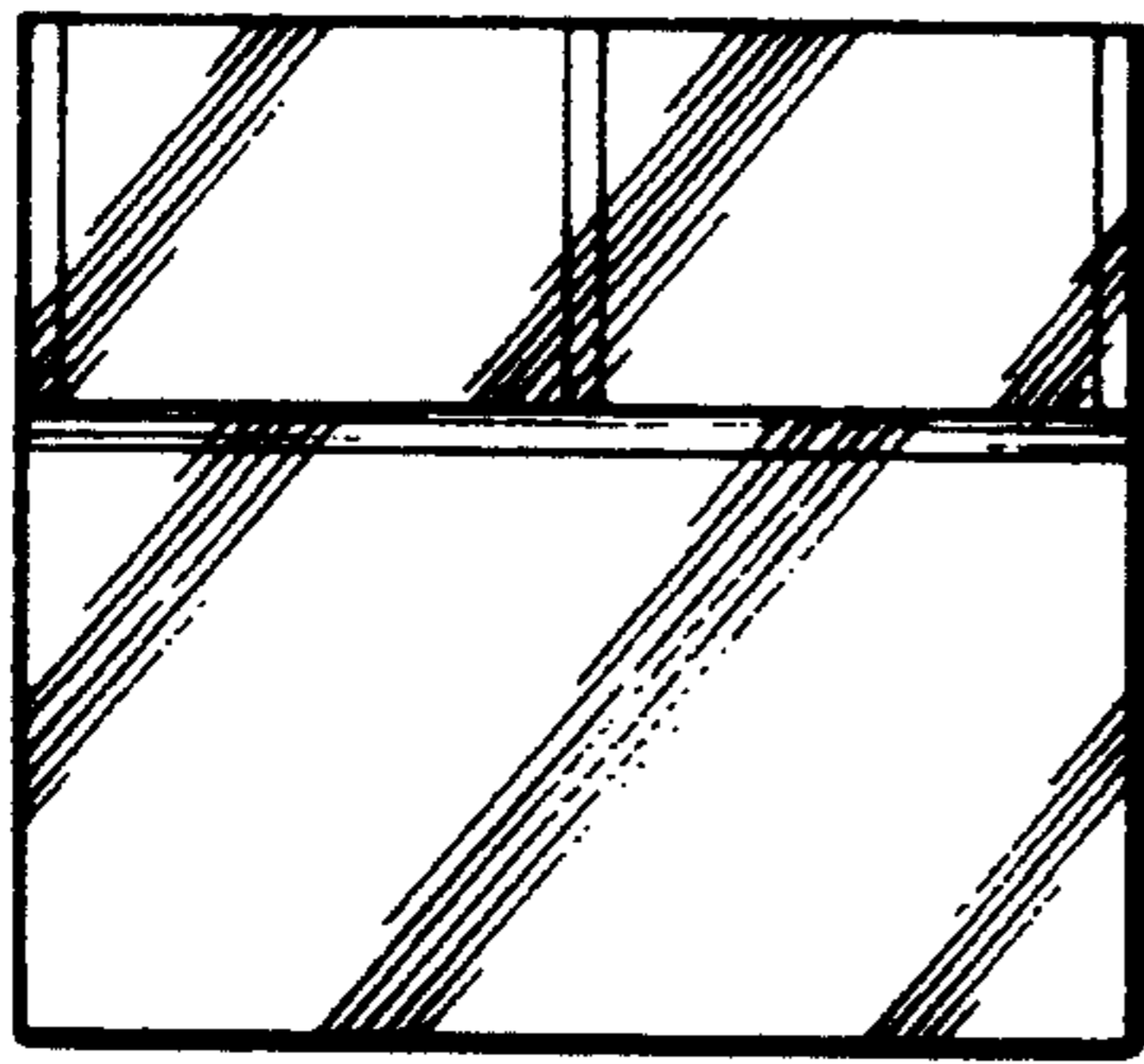

Fig-2

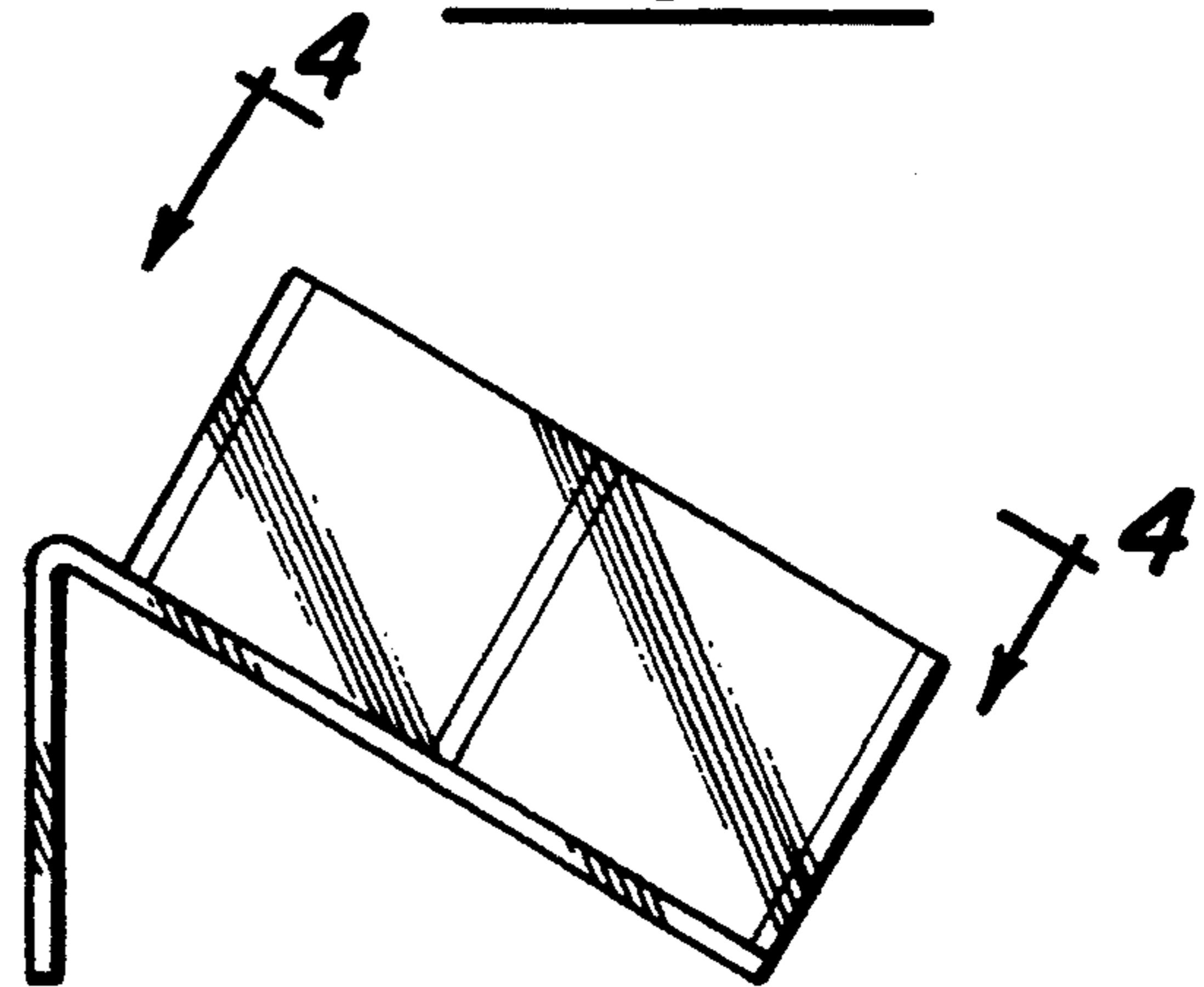

Fig-3

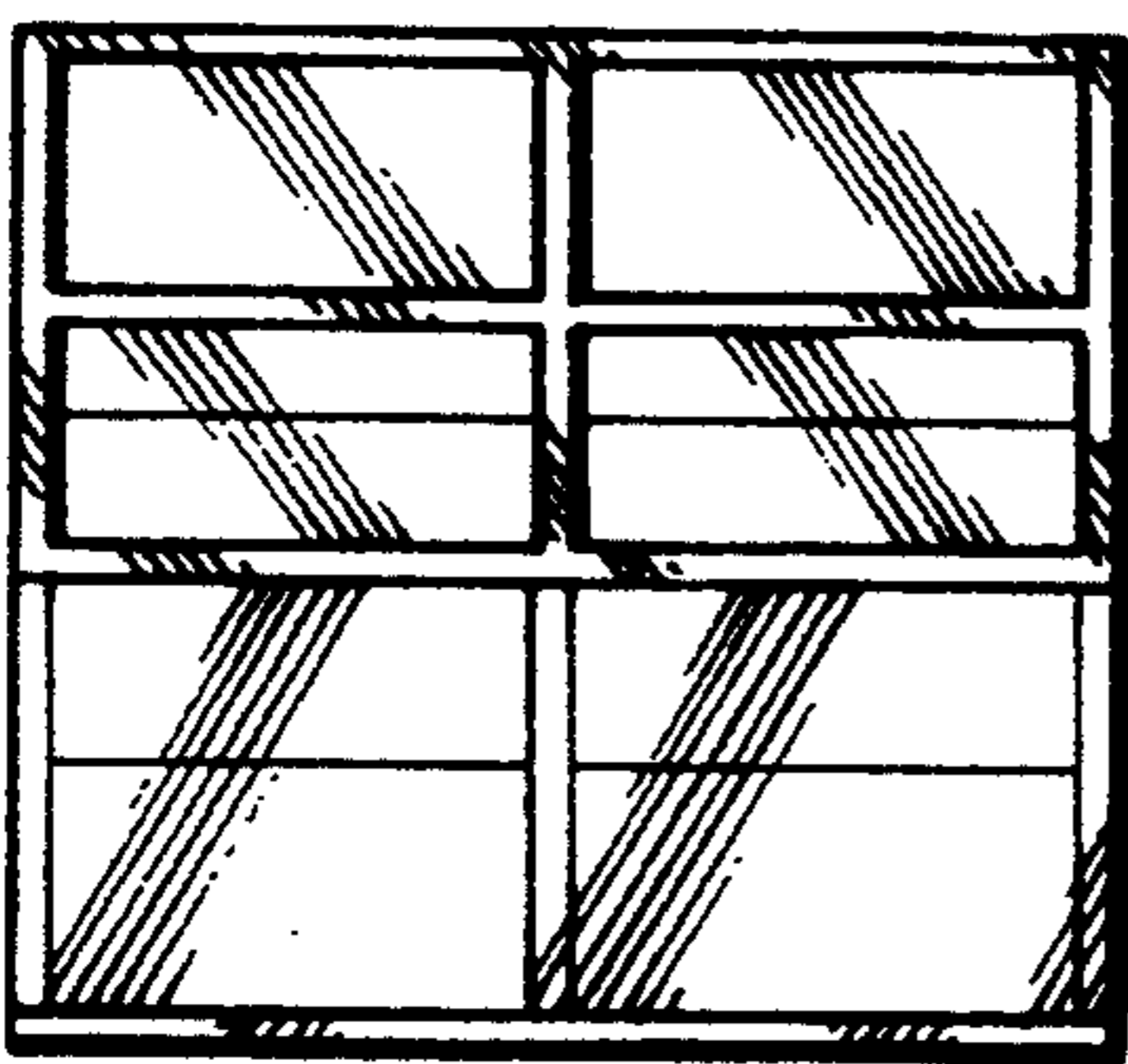

Fig-5

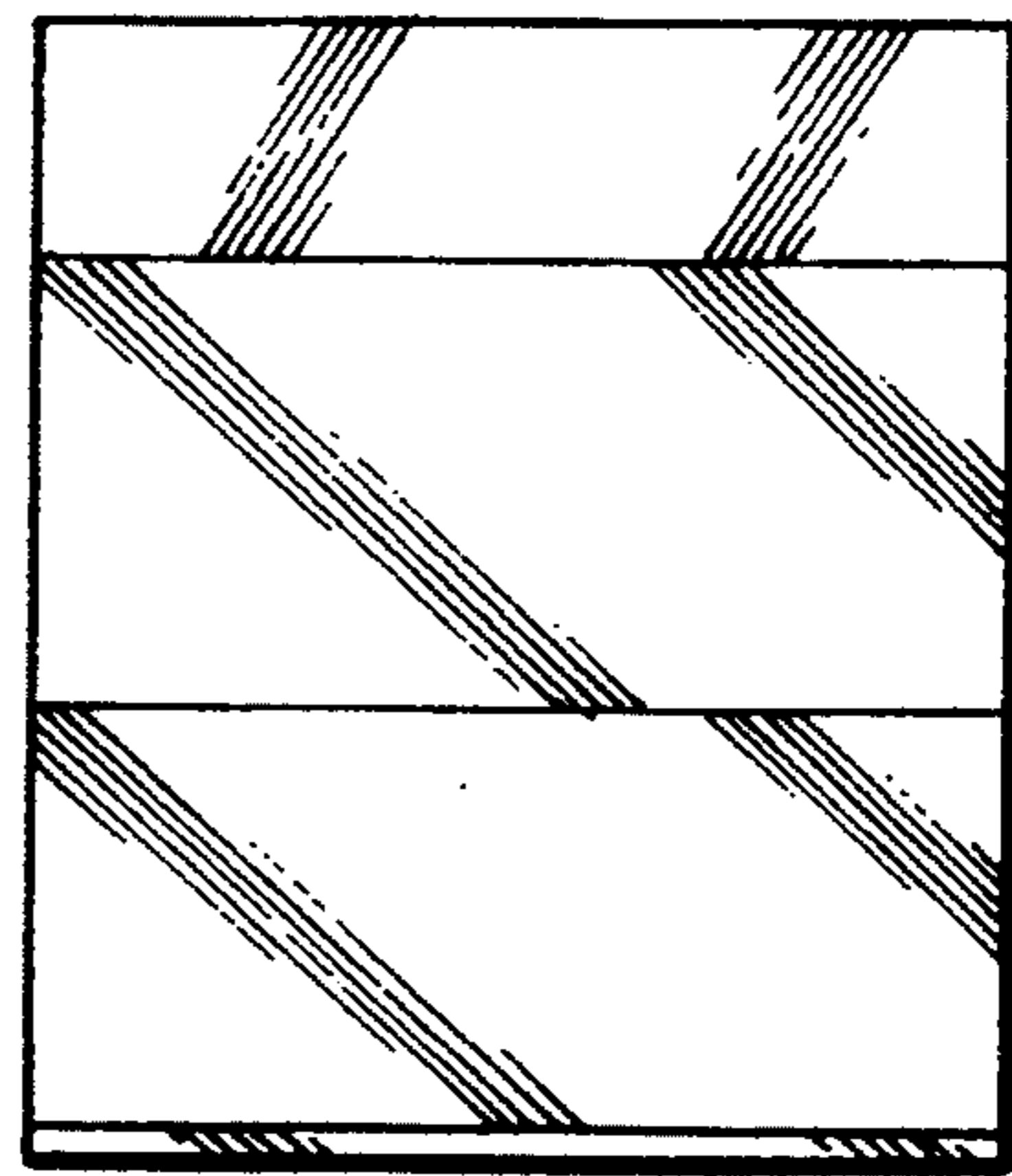

Fig-6