



US00D350987S

United States Patent [19] Wright

[11] Patent Number: **Des. 350,987**
[45] Date of Patent: **** Sep. 27, 1994**

[54] **VENDING MACHINE**

[75] Inventor: **Christopher B. Wright**, San Francisco, Calif.

[73] Assignee: **Wright Food Systems, Inc.**, San Francisco, Calif.

[**] Term: **14 Years**

[21] Appl. No.: **823,563**

[22] Filed: **Jan. 22, 1992**

[52] U.S. Cl. **D20/5**

[58] Field of Search 194/350; 221/194, 195, 221/196, 24; 312/45, 36; D9/430, 307; D7/300.2, 509; D20/5, 4

[56] **References Cited**

U.S. PATENT DOCUMENTS

- D. 290,272 6/1987 McGarrah D20/5
- D. 290,619 6/1987 Brandes et al. D20/5
- D. 297,742 9/1988 Morgan, Jr. D20/5 X
- 4,121,835 10/1978 Garabedian D7/300.24 R
- 4,356,927 11/1982 Cooper et al. D7/300.24 R
- 4,923,090 5/1990 Rockola et al. 194/350 X

FOREIGN PATENT DOCUMENTS

- 122785 3/1990 Spain .
- 2025473 8/1990 Spain .
- 2029427 3/1991 Spain .

Primary Examiner—Bernard Ansher
Assistant Examiner—Paula Mortimer
Attorney, Agent, or Firm—Ostrager, Chong & Flaherty

[57] **CLAIM**

The ornamental design for a vending machine, as shown and described.

DESCRIPTION

FIG. 1 is a front perspective view of a vending machine showing my new design, the vending machine being embodied with either a single door on one side or two doors on opposite sides of its cylindrical body;

FIG. 2 is a front elevational view of the vending machine design of FIG. 1, showing a full view of one door;

FIG. 3 is a side elevational view of FIG. 1, the difference being the two doors;

FIG. 4 is a top plan view of FIG. 3;

FIG. 5 is a bottom plan view of FIG. 3;

FIG. 6 is a top plan view of FIG. 3 in an open position;

FIG. 7 is a side elevational view of FIG. 1, the difference being the single door;

FIG. 8 is a top plan view of FIG. 7;

FIG. 9 is a bottom plan view of FIG. 7;

FIG. 10 is a top plan view of FIG. 7 in an open position;

FIG. 11 is a side elevational view of a third embodiment showing my new design, the difference being the single door and the truncated rear portion;

FIG. 12 is a top plan view of FIG. 11;

FIG. 13 is a bottom plan view of FIG. 11;

FIG. 14 is a top plan view of FIG. 11 in an open position;

FIG. 15 is a front elevational view of a fourth embodiment showing my new design, the difference being the addition of the straw and the pop-top;

FIG. 16 is a side elevational view of FIG. 15;

FIG. 17 is a top plan view of FIG. 15; and,

FIG. 18 is a front elevational view of a fifth embodiment showing my new design, the difference being the truncated rear portion and the addition of the straw and the pop-top.

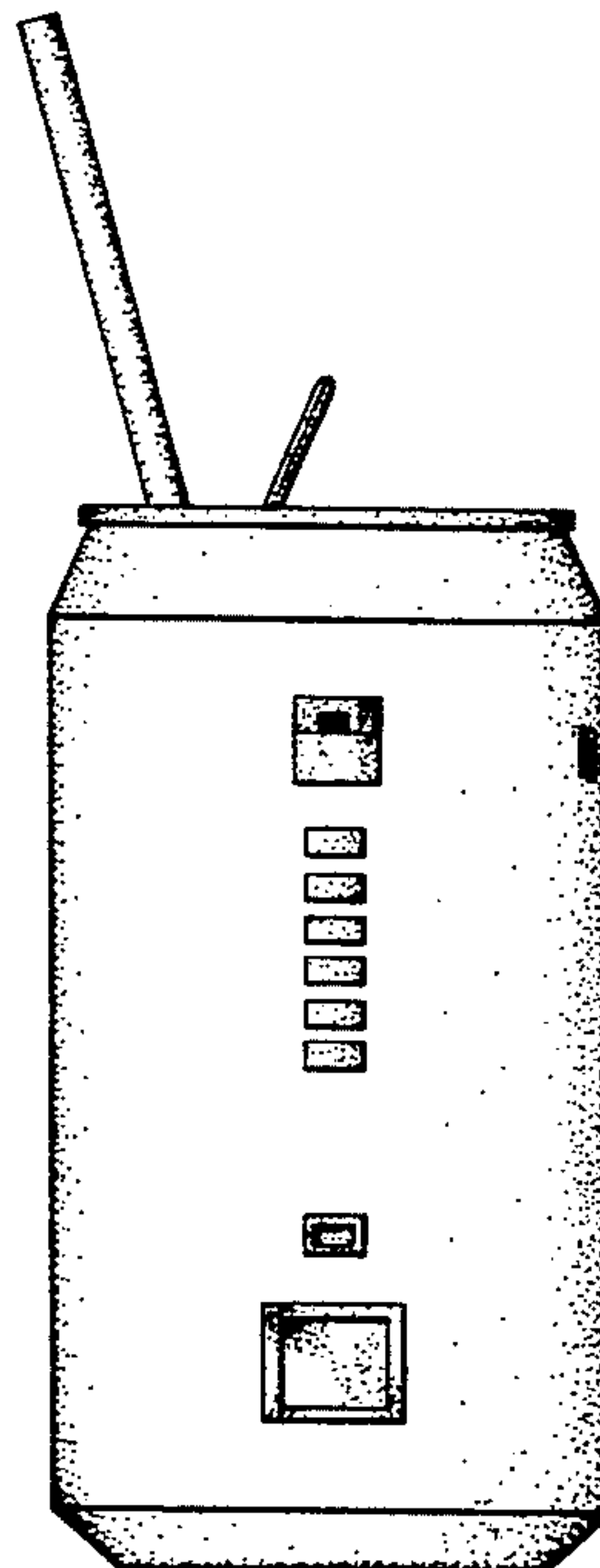
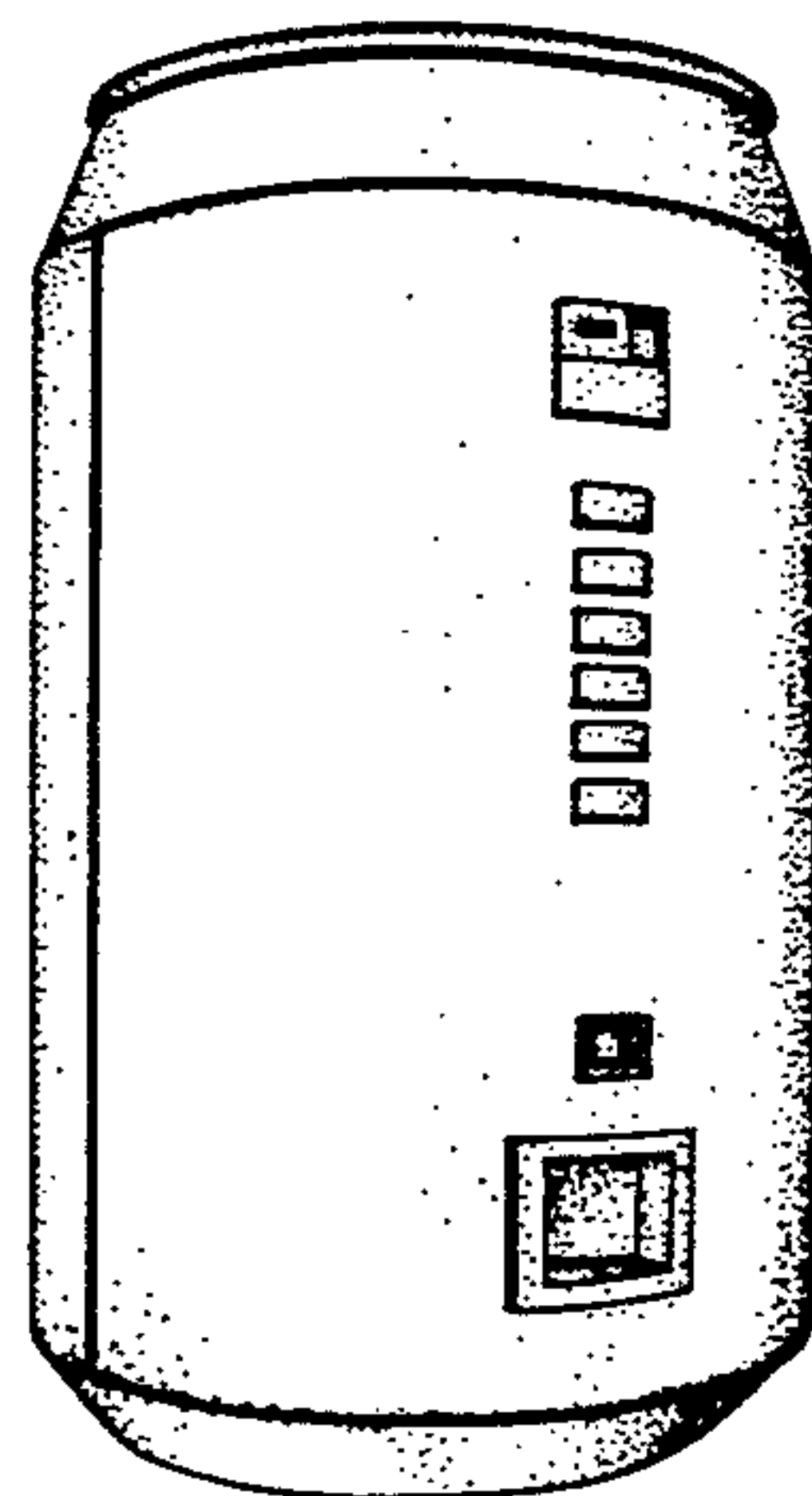

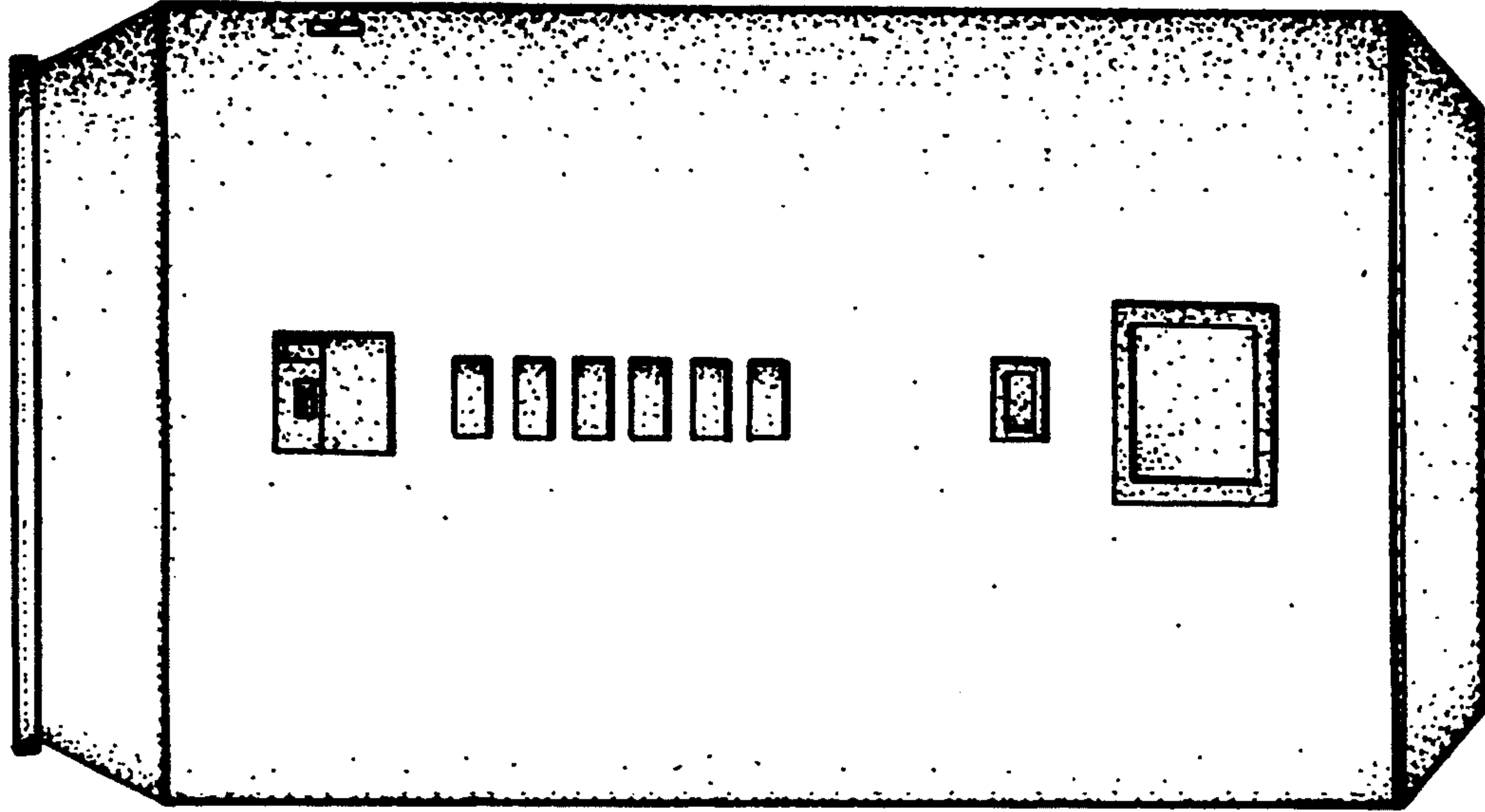

FIG. 2

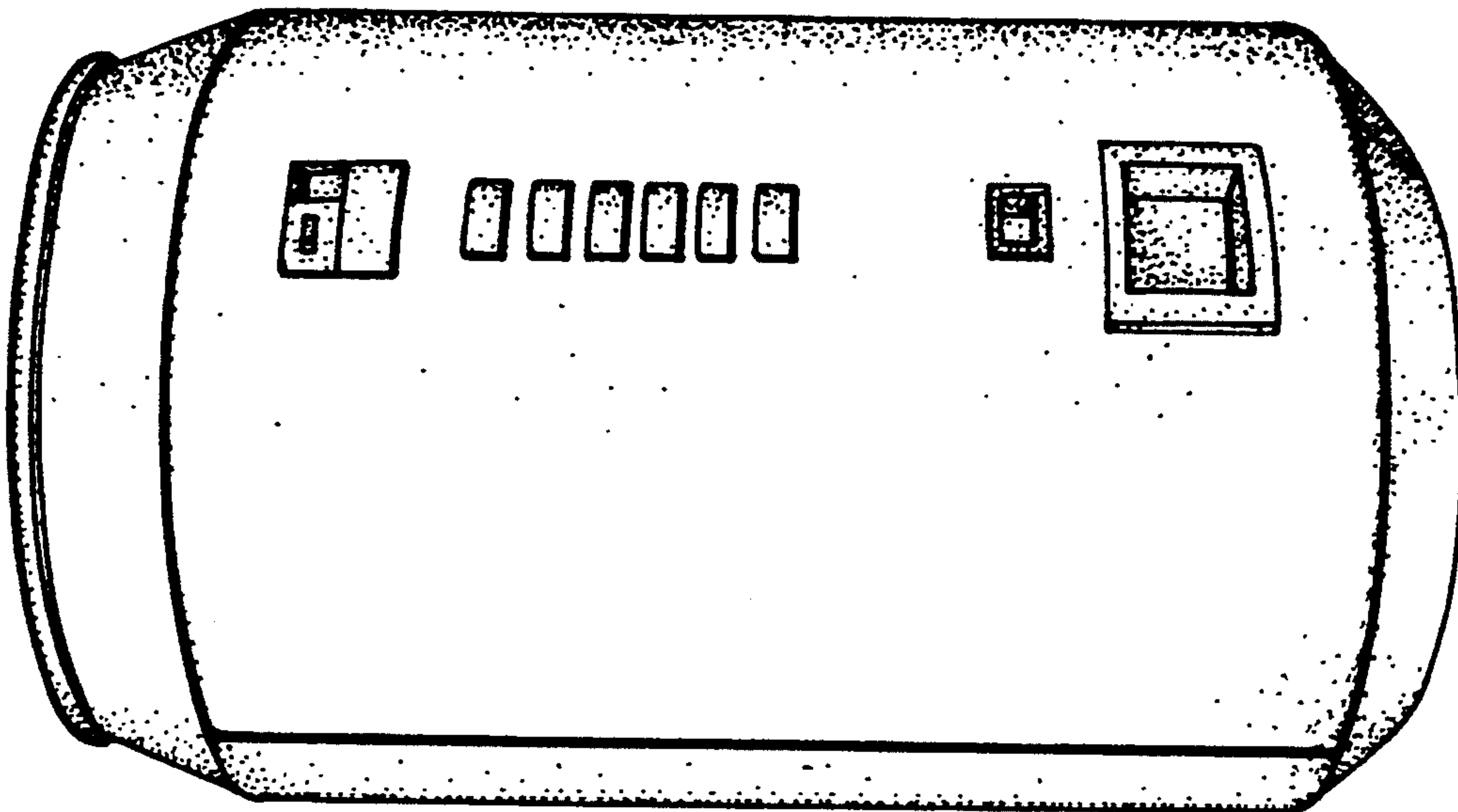

FIG. 1

FIG. 3

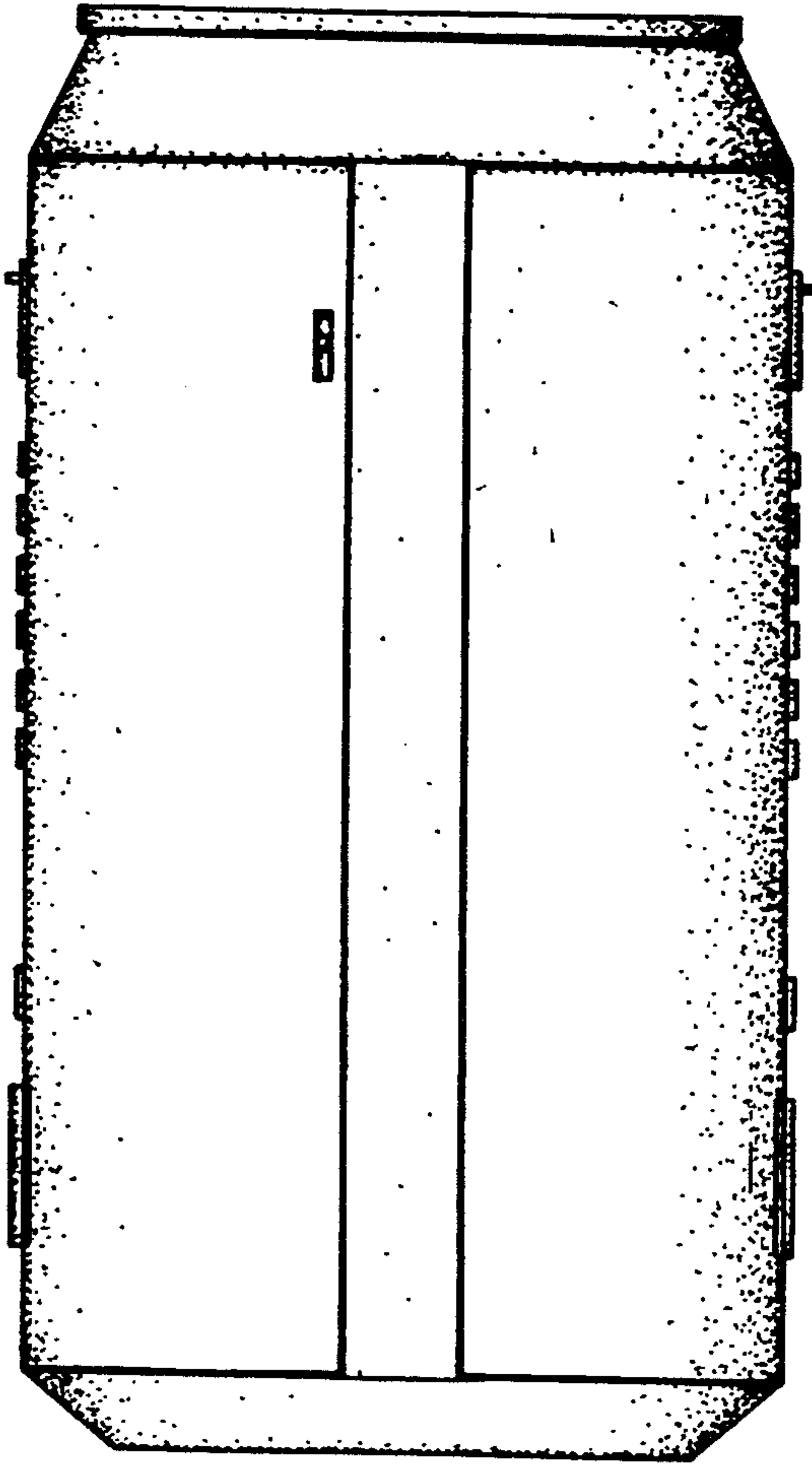

FIG. 4

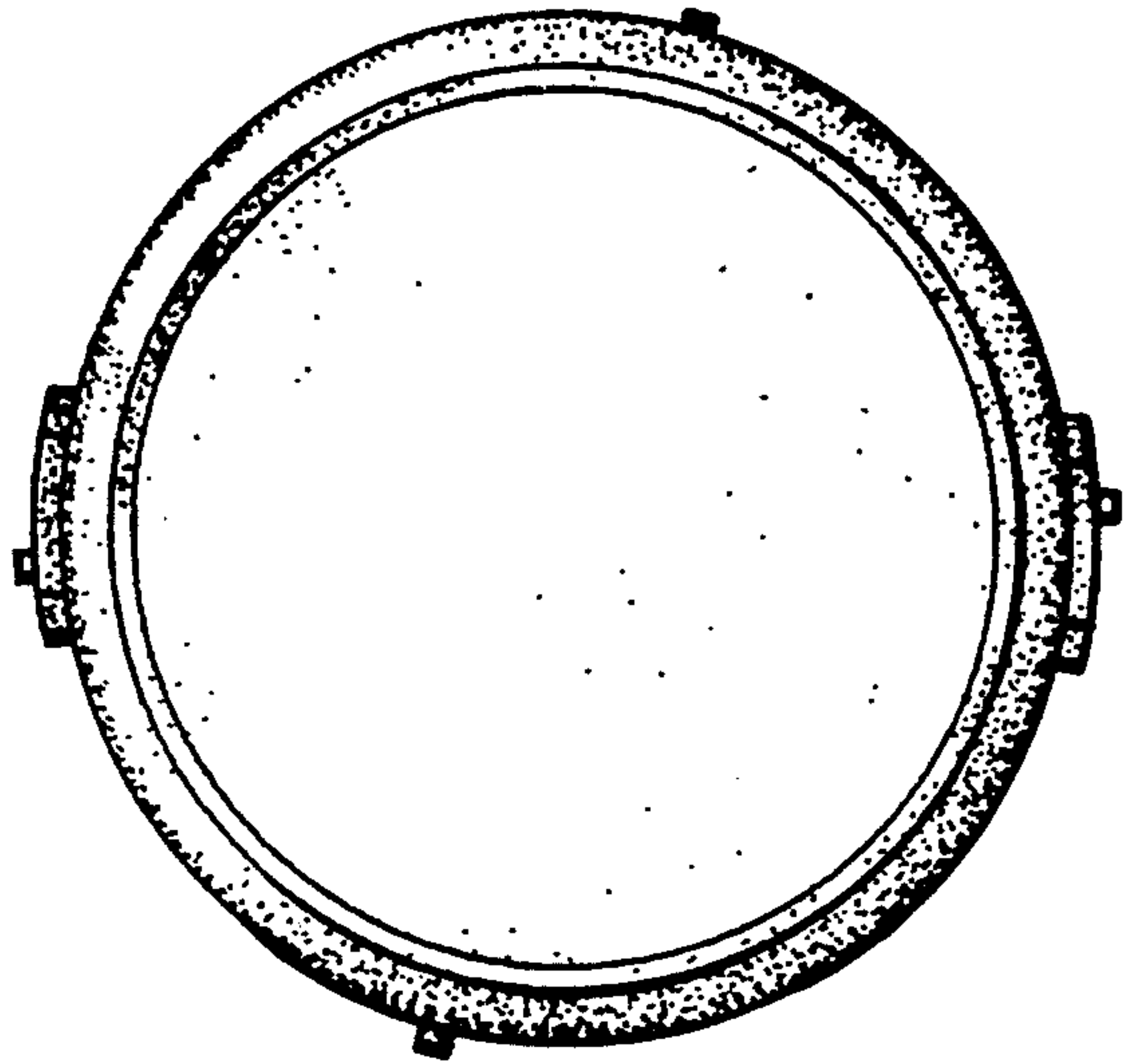

FIG. 5

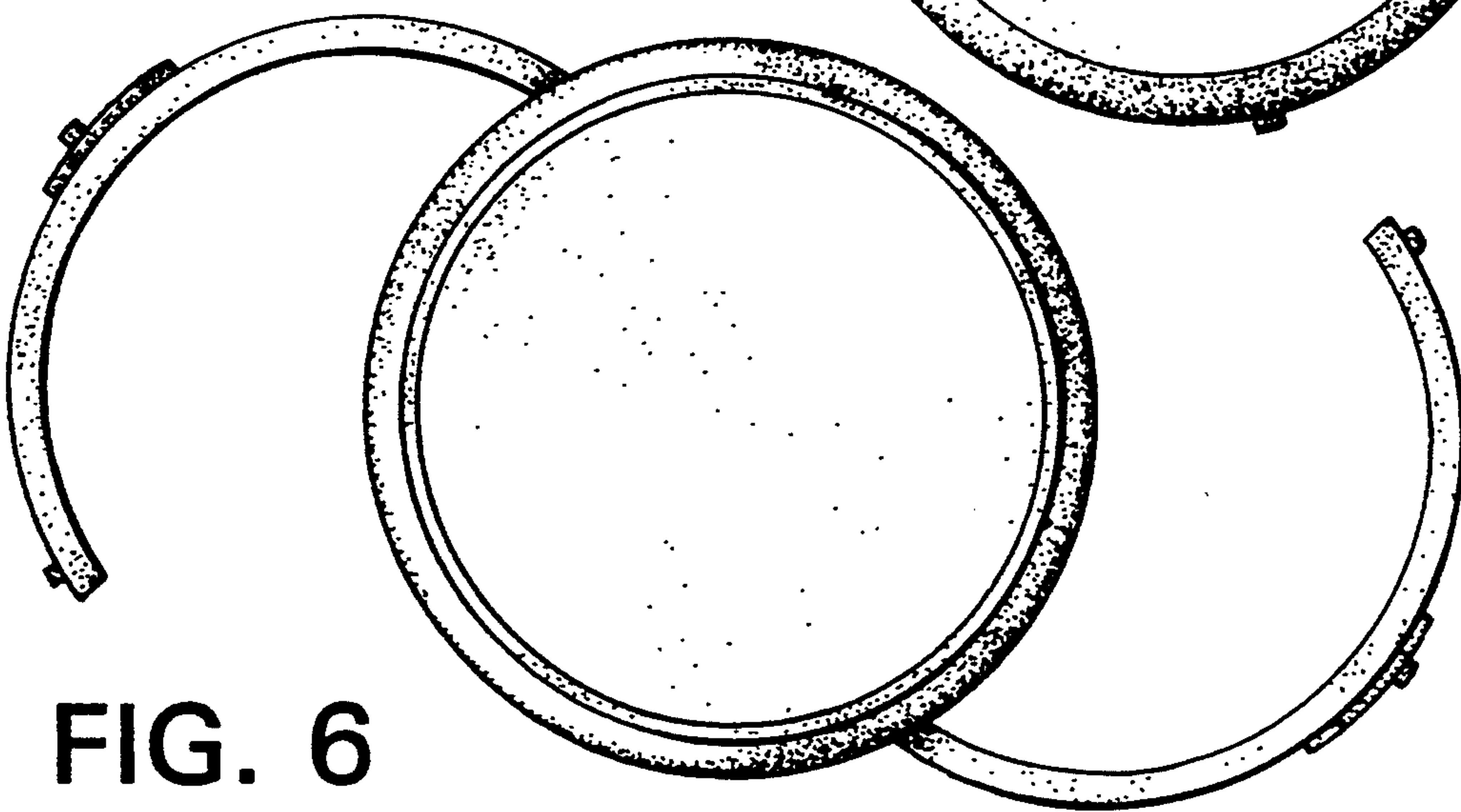
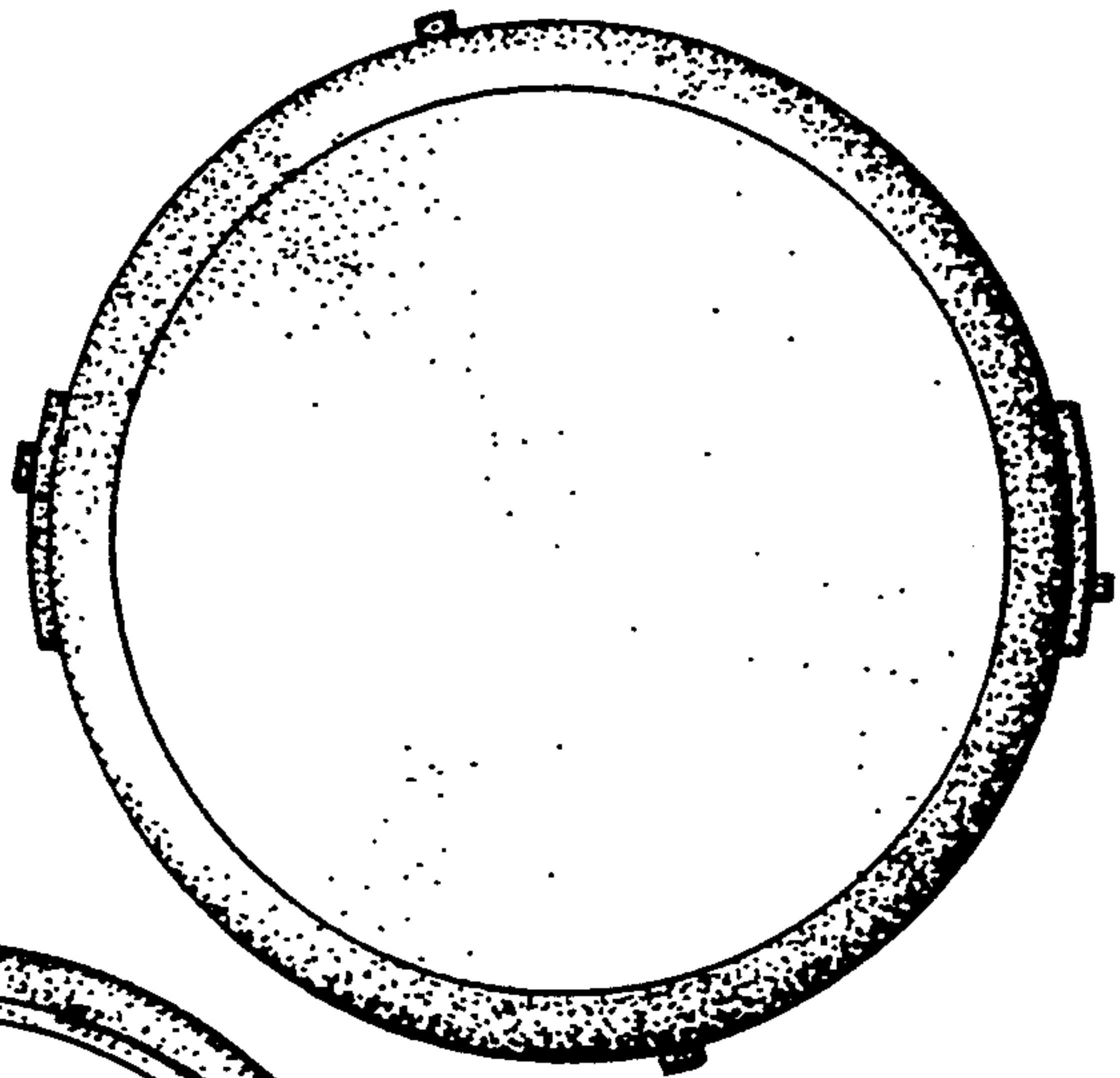

FIG. 6

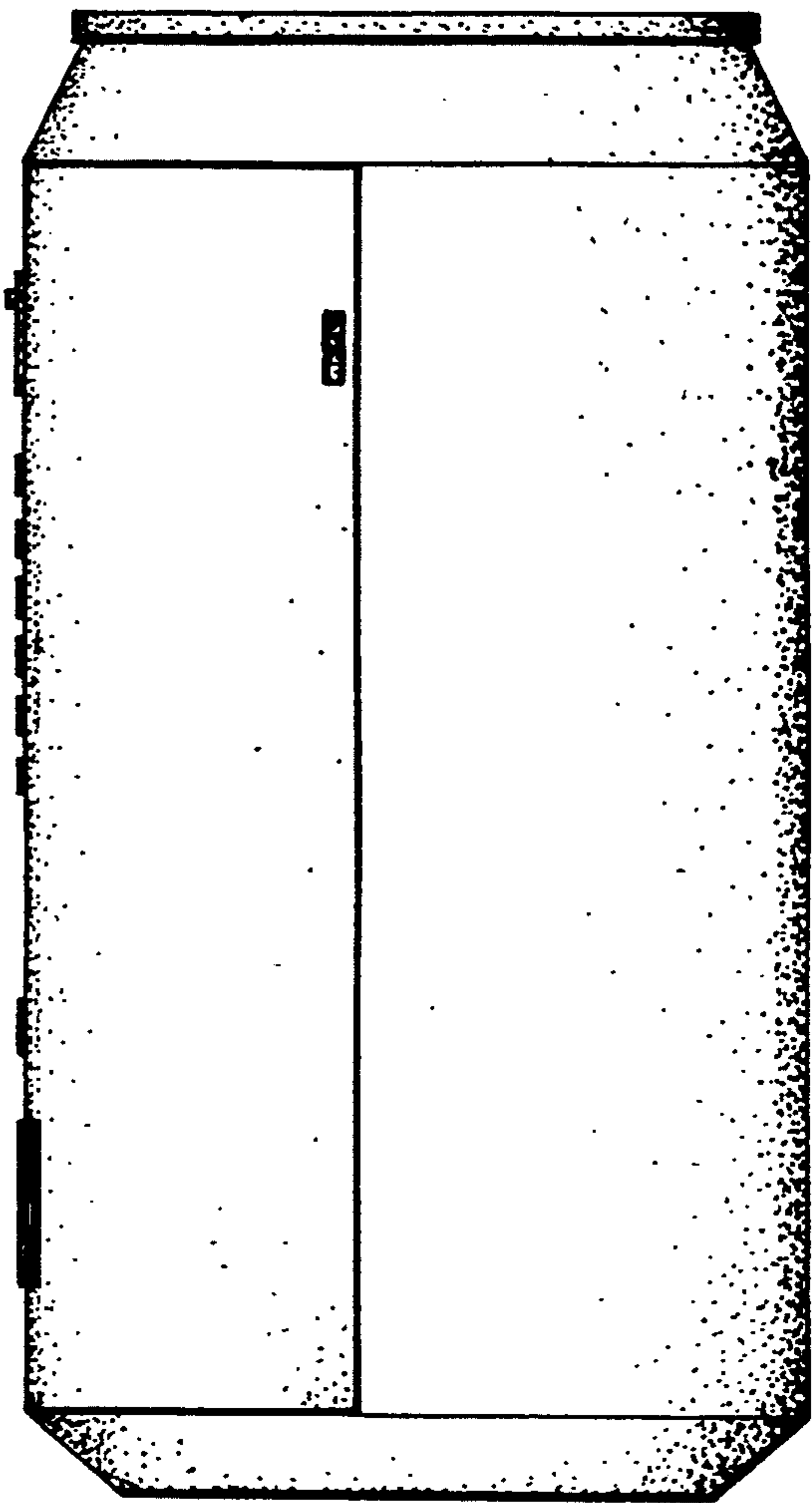

FIG. 7

FIG. 8

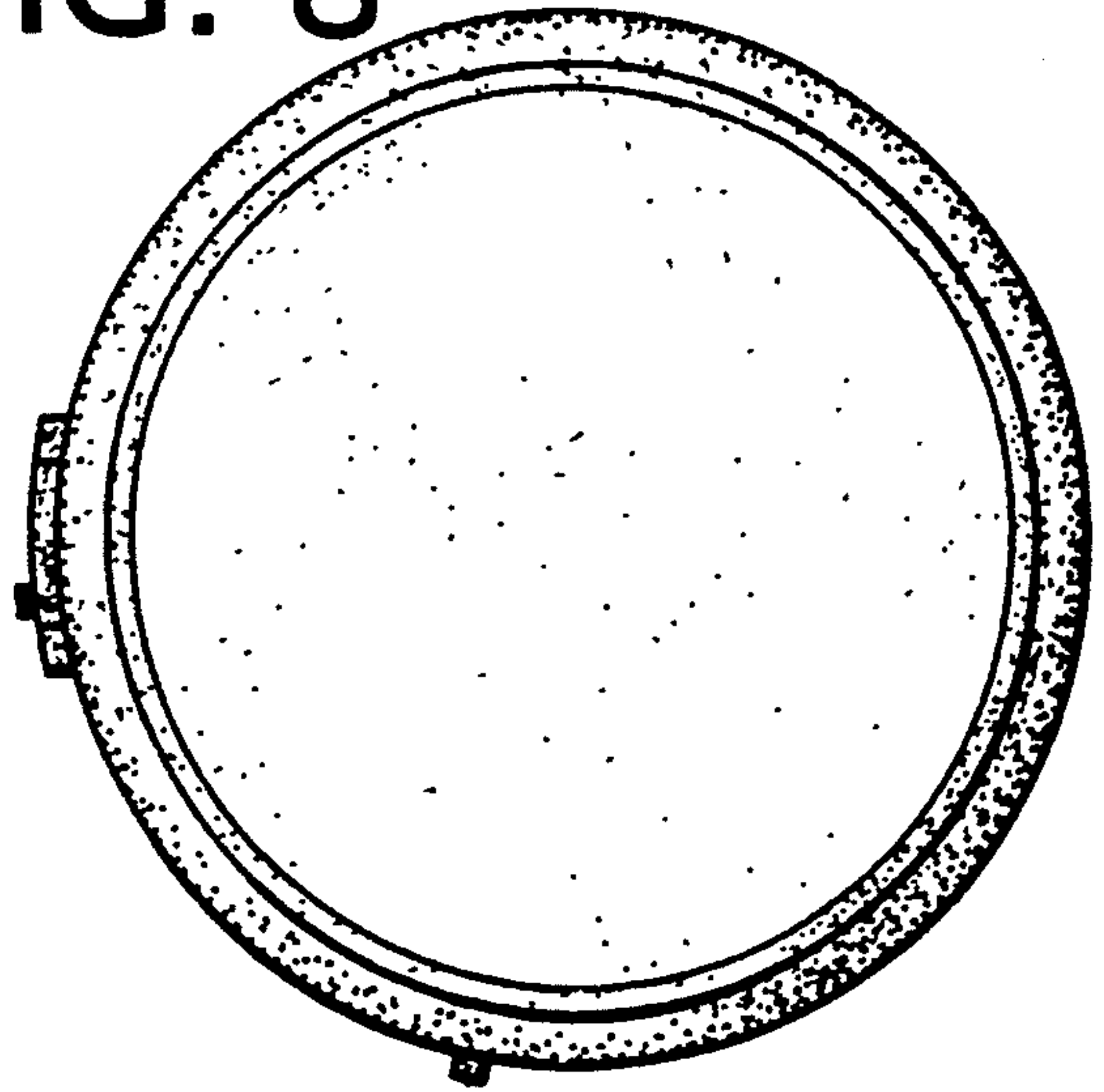

FIG. 9

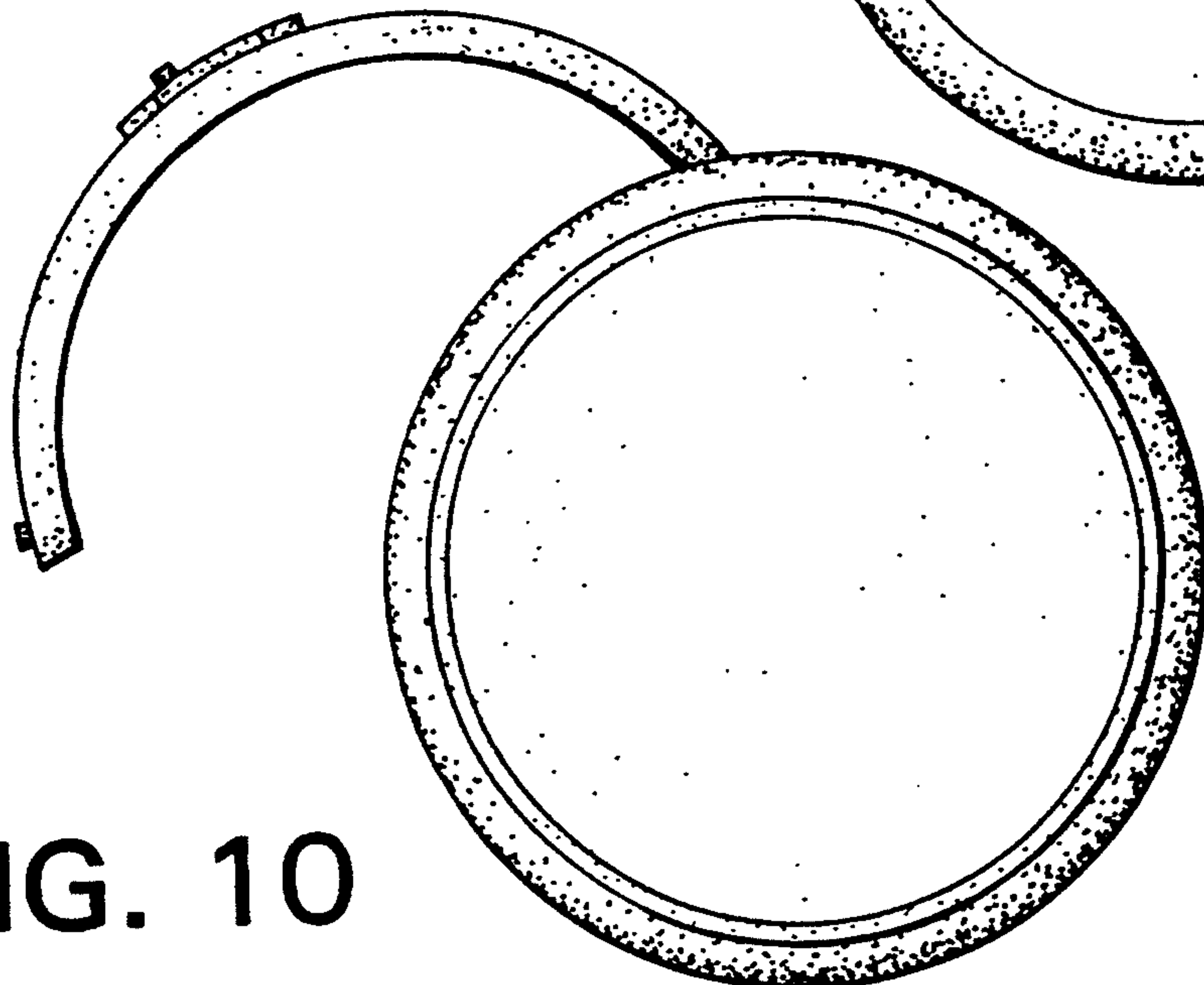
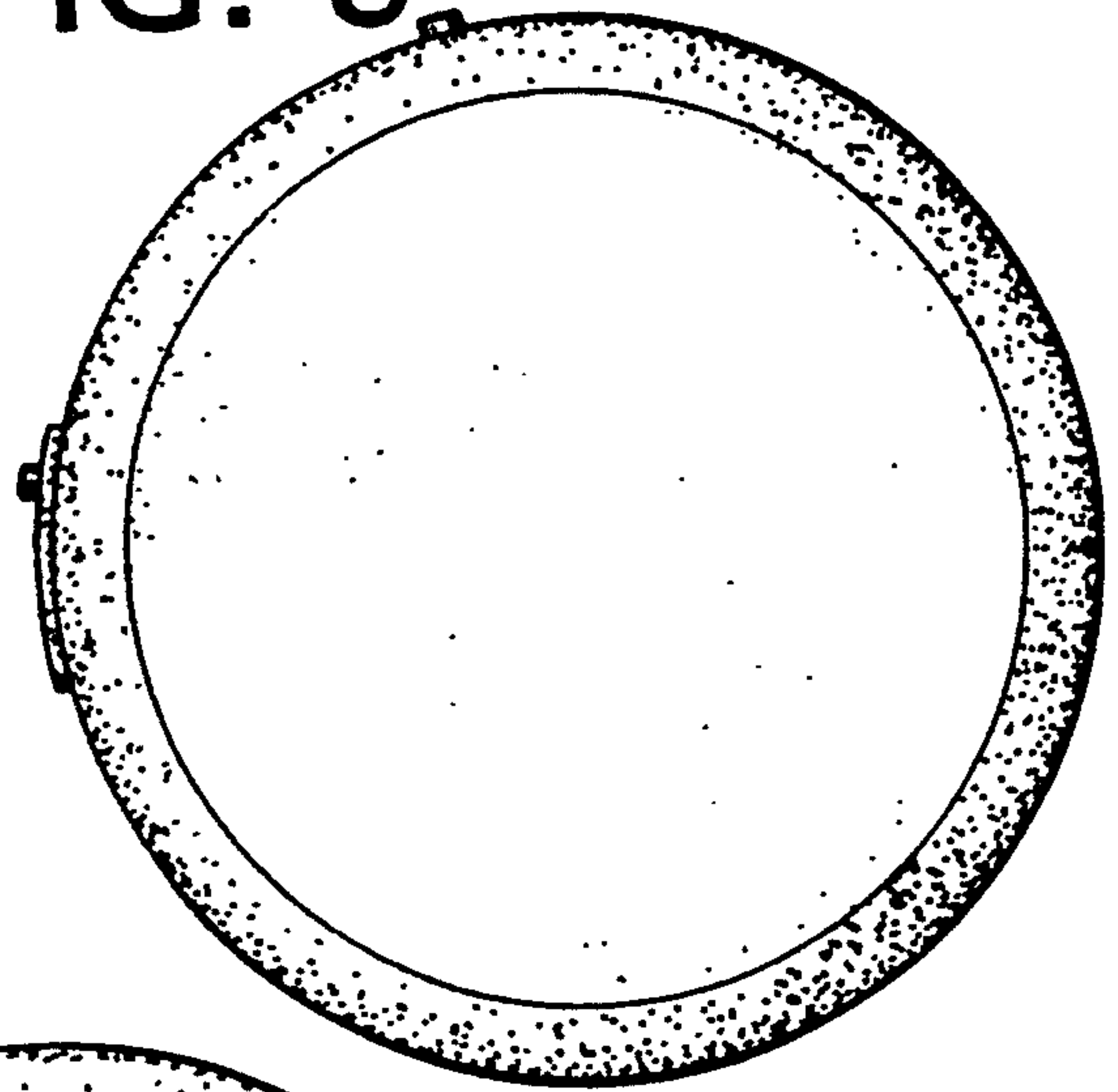

FIG. 10

FIG. 11

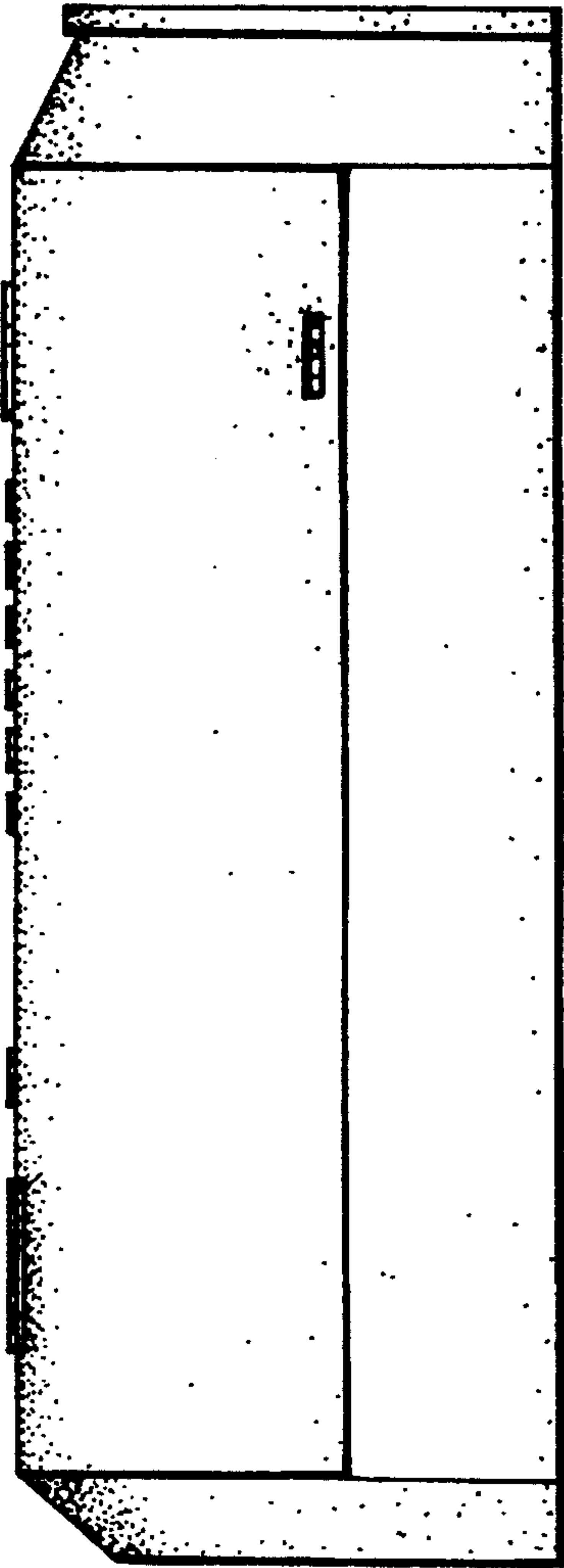

FIG. 12

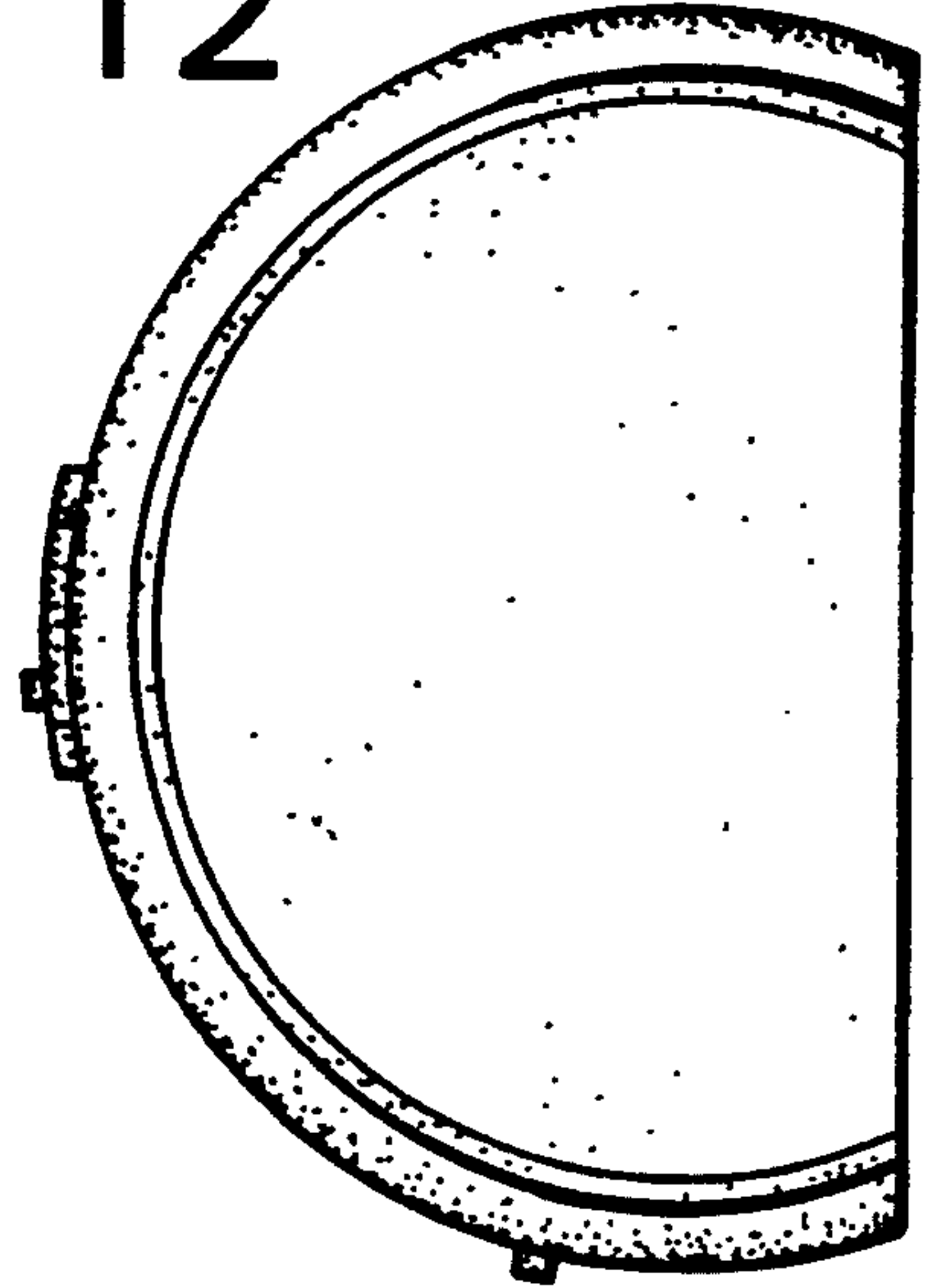

FIG. 13

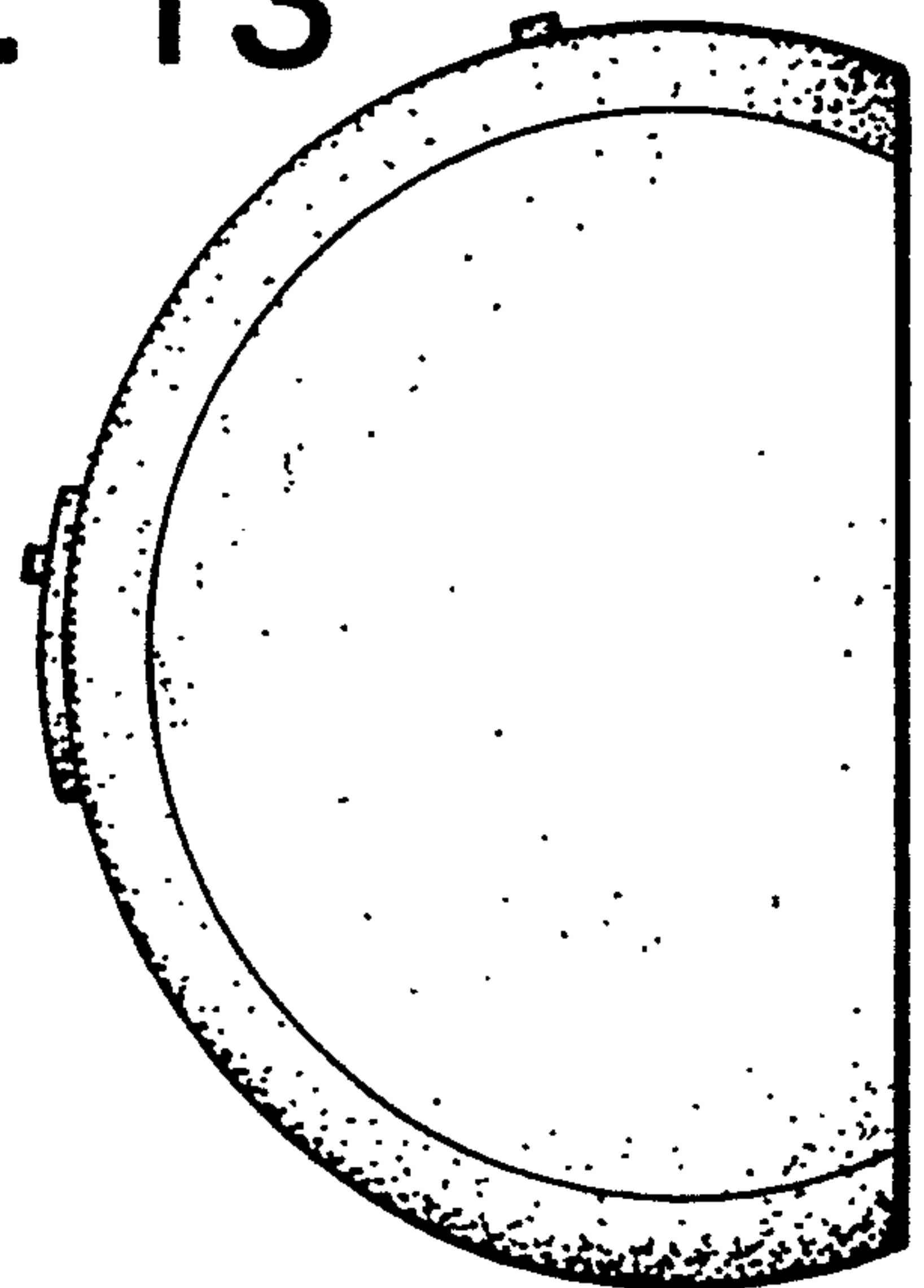
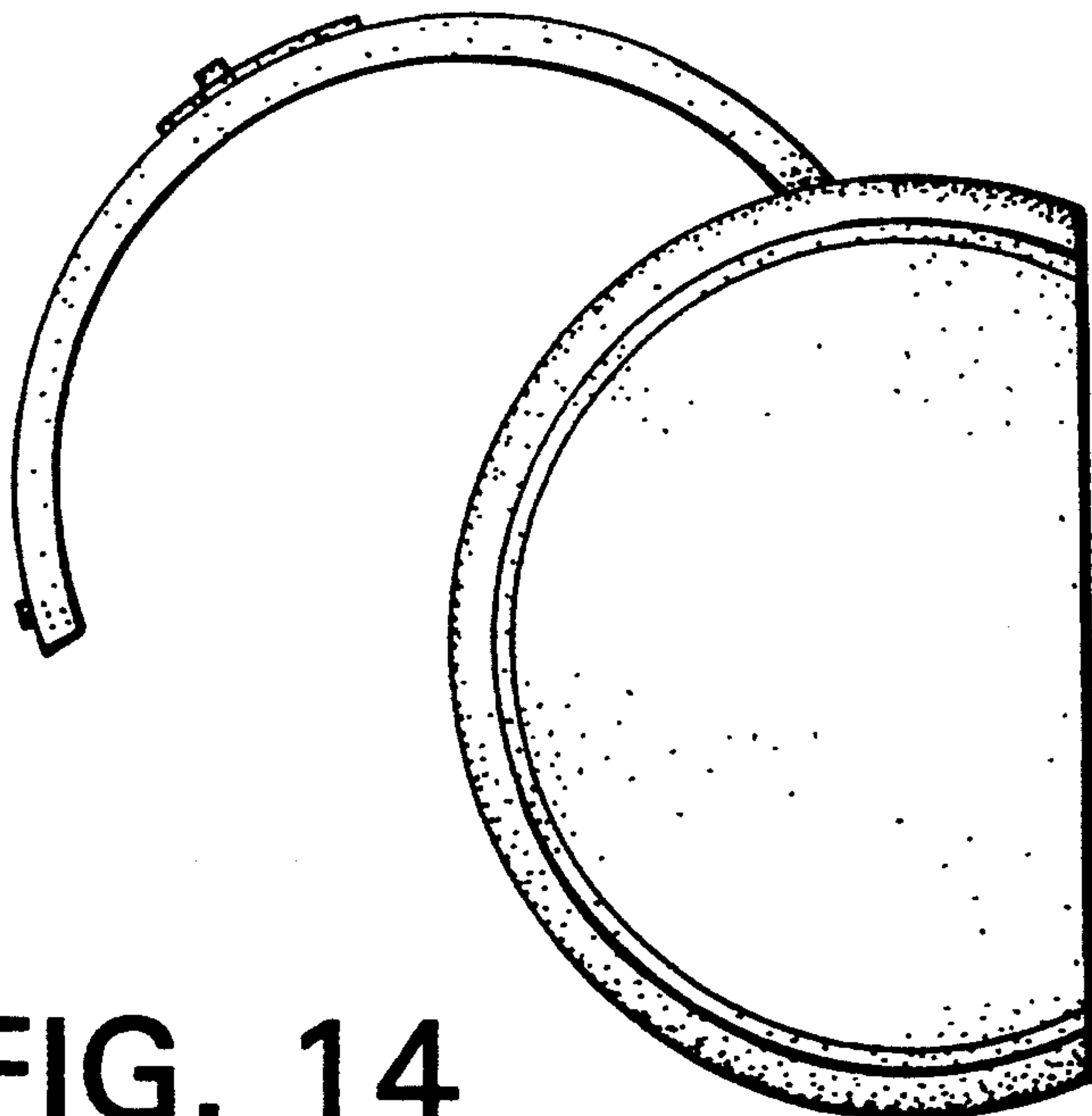

FIG. 14



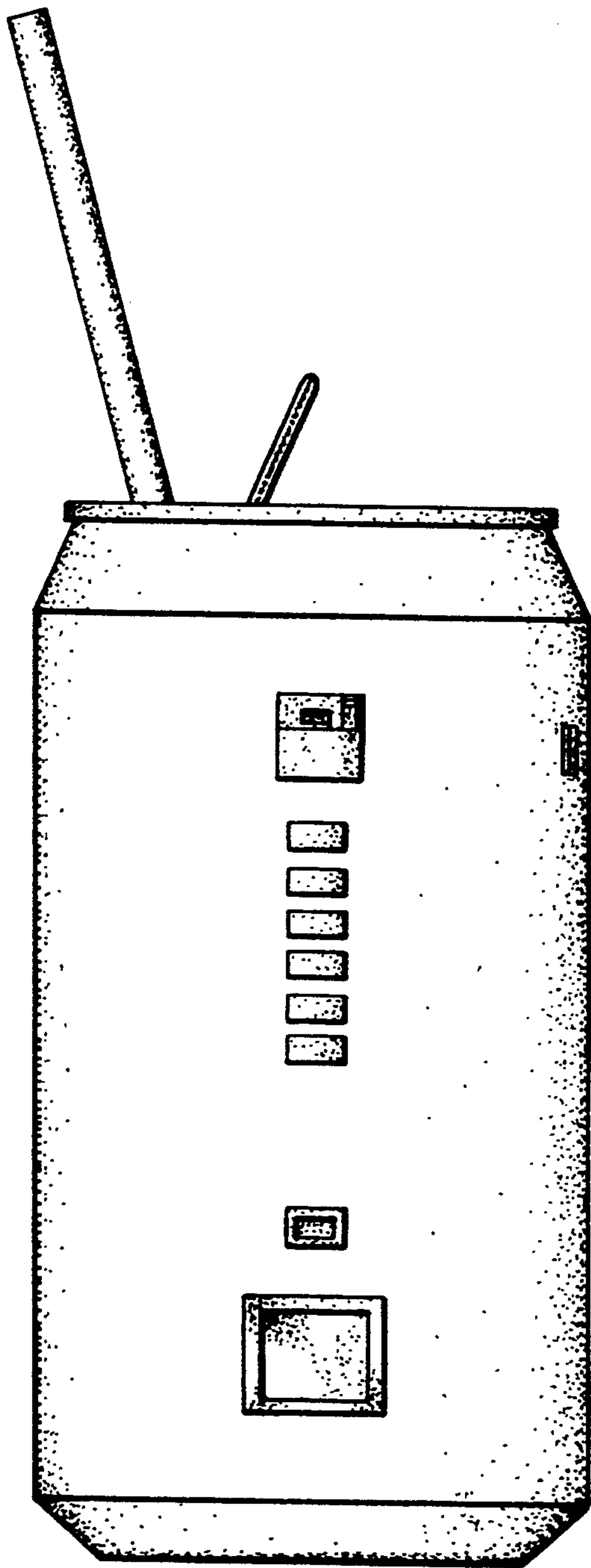

FIG. 15

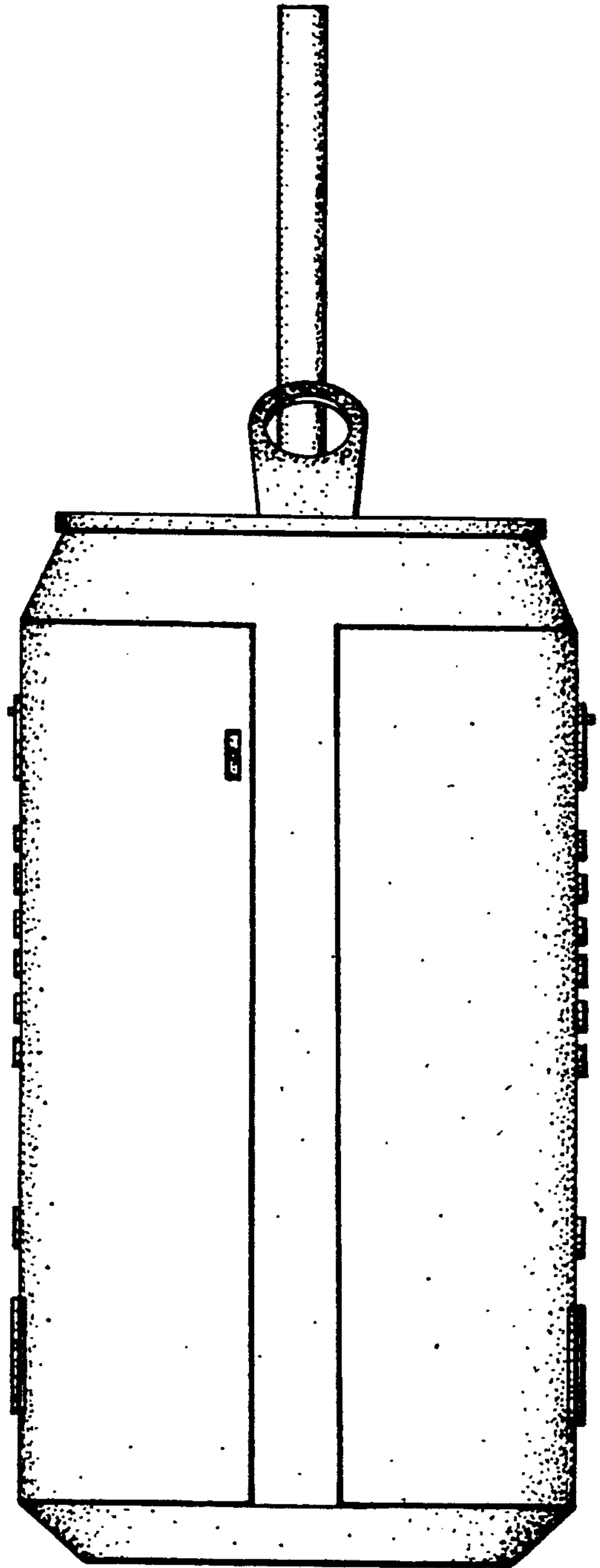

FIG. 16

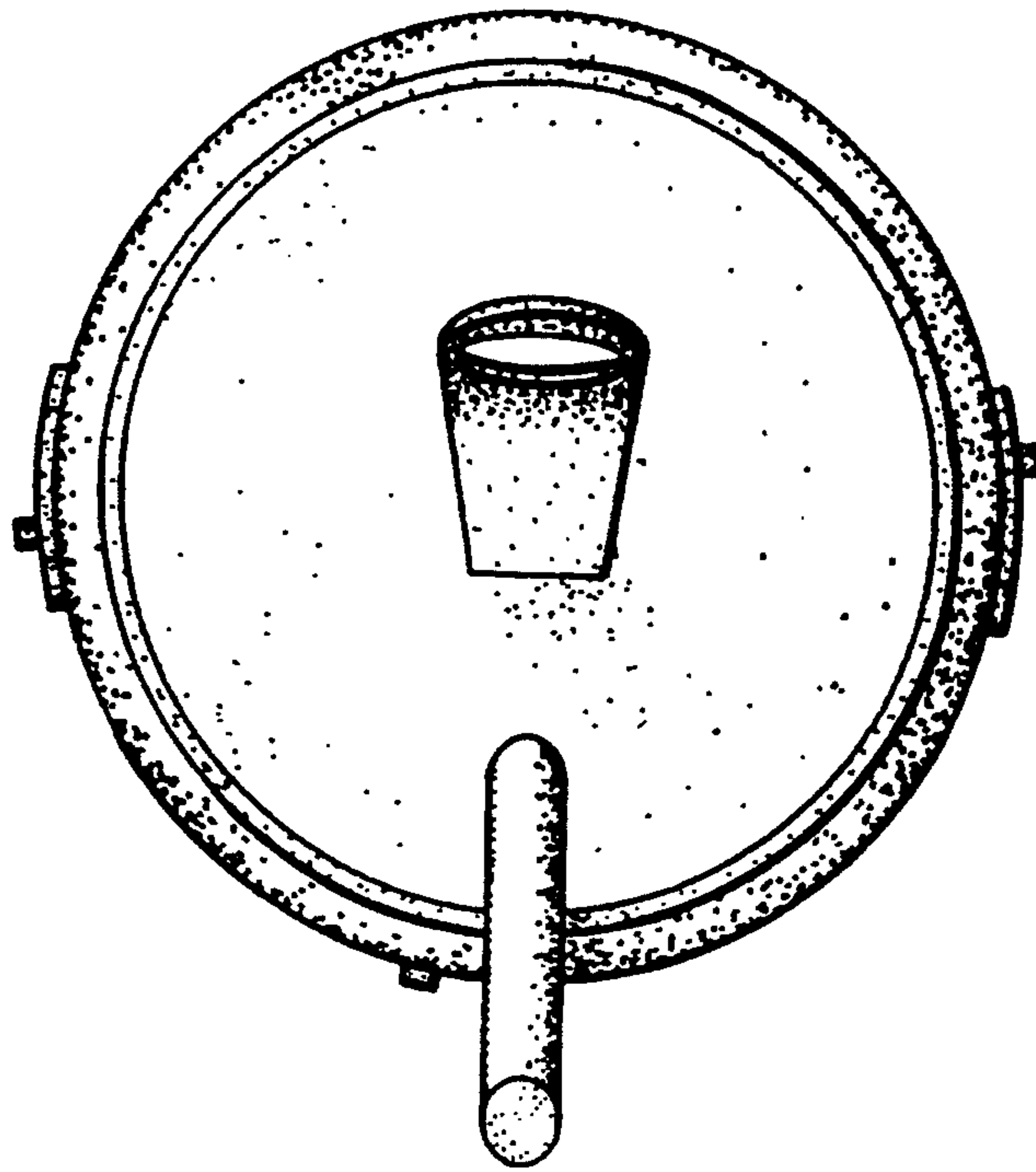

FIG. 17

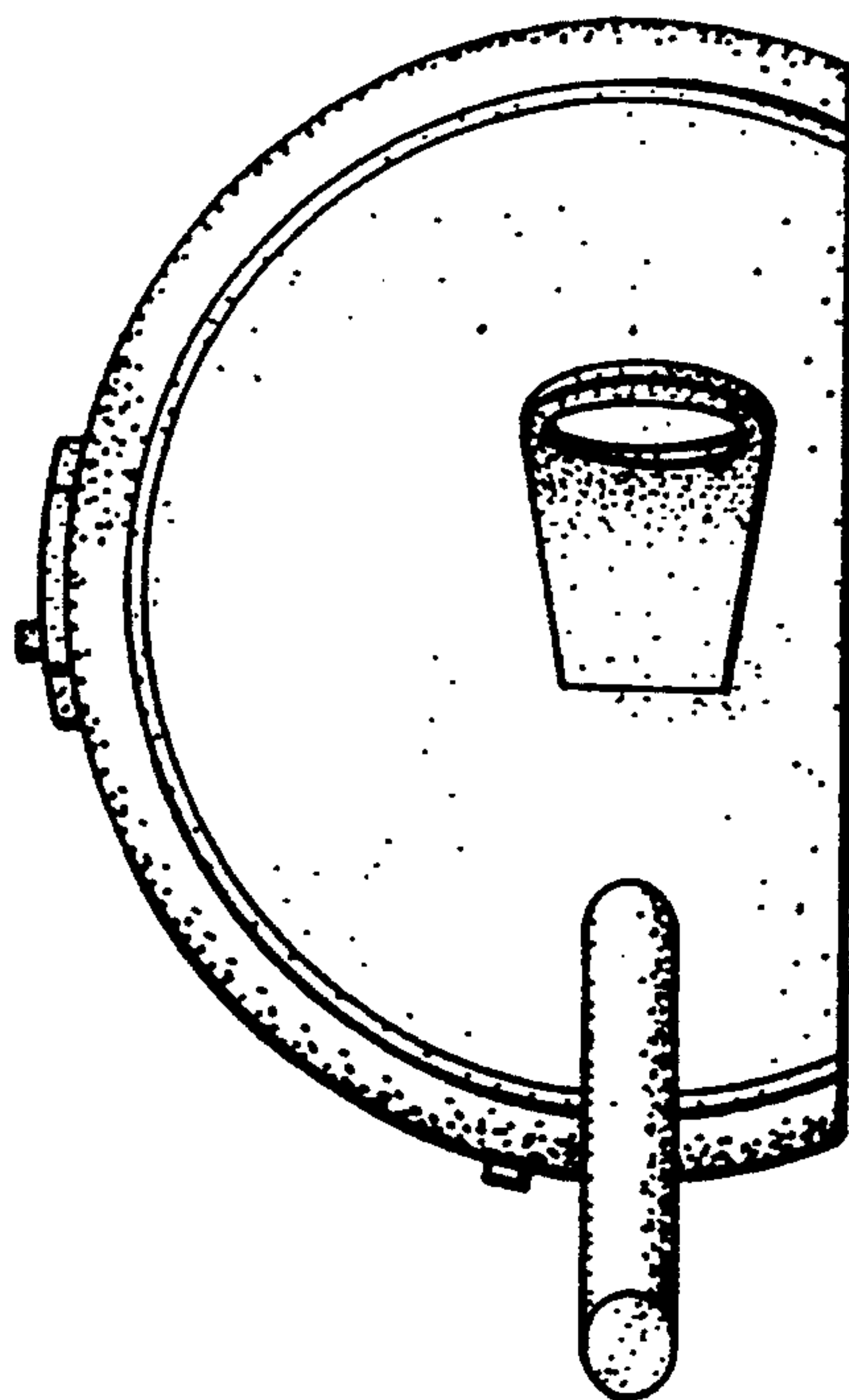

FIG. 18