



US00D350975S

United States Patent [19]

[11] Patent Number: **Des. 350,975**

Mizuta

[45] Date of Patent: **** Sep. 27, 1994**

[54] **IMAGE FORMING APPARATUS**

[75] Inventor: **Ryoko Mizuta, Kawasaki, Japan**

[73] Assignee: **Canon Kabushiki Kaisha, Tokyo, Japan**

[**] Term: **14 Years**

[21] Appl. No.: **429**

[22] Filed: **Oct. 14, 1992**

[30] **Foreign Application Priority Data**

Apr. 24, 1992 [JP] Japan 4-12484

[52] U.S. Cl. **D18/43; D18/40**

[58] Field of Search 355/200, 245, 260; 222/DIG. 1, 166, 240, 325, 541; 206/216, 229, 316; 118/653; D18/40, 43, 36

[56] **References Cited**

U.S. PATENT DOCUMENTS

- D. 276,916 12/1984 Masaki D18/36
- D. 277,289 1/1985 Sabin D18/43
- D. 287,023 12/1986 Masaki D18/36
- D. 298,255 10/1988 Hirata D18/36
- D. 298,259 10/1988 Masaki D18/36
- D. 298,333 12/1988 Masaki et al. D18/40 X
- D. 298,334 11/1988 Masaki et al. D18/36
- D. 298,335 11/1988 Masaki et al. D18/36

- D. 298,336 11/1988 Masaki D18/36
- D. 303,541 9/1989 Aoyama D18/36
- D. 303,542 9/1989 Tashiro D18/36
- D. 308,885 6/1990 Okayama et al. D18/40
- D. 313,615 1/1991 Tokuda D18/36
- D. 313,616 1/1991 Tokuda D18/36
- D. 313,813 1/1991 Tokuda D18/36
- D. 332,962 2/1993 Kikuchi et al. D18/40 X
- 4,873,940 10/1989 Ishikawa et al. 118/653 X
- 4,949,399 8/1990 Williams et al. 355/245 X

Primary Examiner—Alan P. Douglas
Assistant Examiner—Caron D. Veynar
Attorney, Agent, or Firm—Fitzpatrick, Cella, Harper & Scinto

[57] **CLAIM**

The ornamental design for an image forming apparatus, as shown and described.

DESCRIPTION

FIG. 1 is a front elevational view of an image forming apparatus showing my new design; FIG. 2 is a rear elevational view thereof; FIG. 3 is a top plan view thereof; FIG. 4 is a bottom plan view thereof; FIG. 5 is a left side elevational view thereof; FIG. 6 is a right side elevational view thereof; and, FIG. 7 is a perspective view thereof.

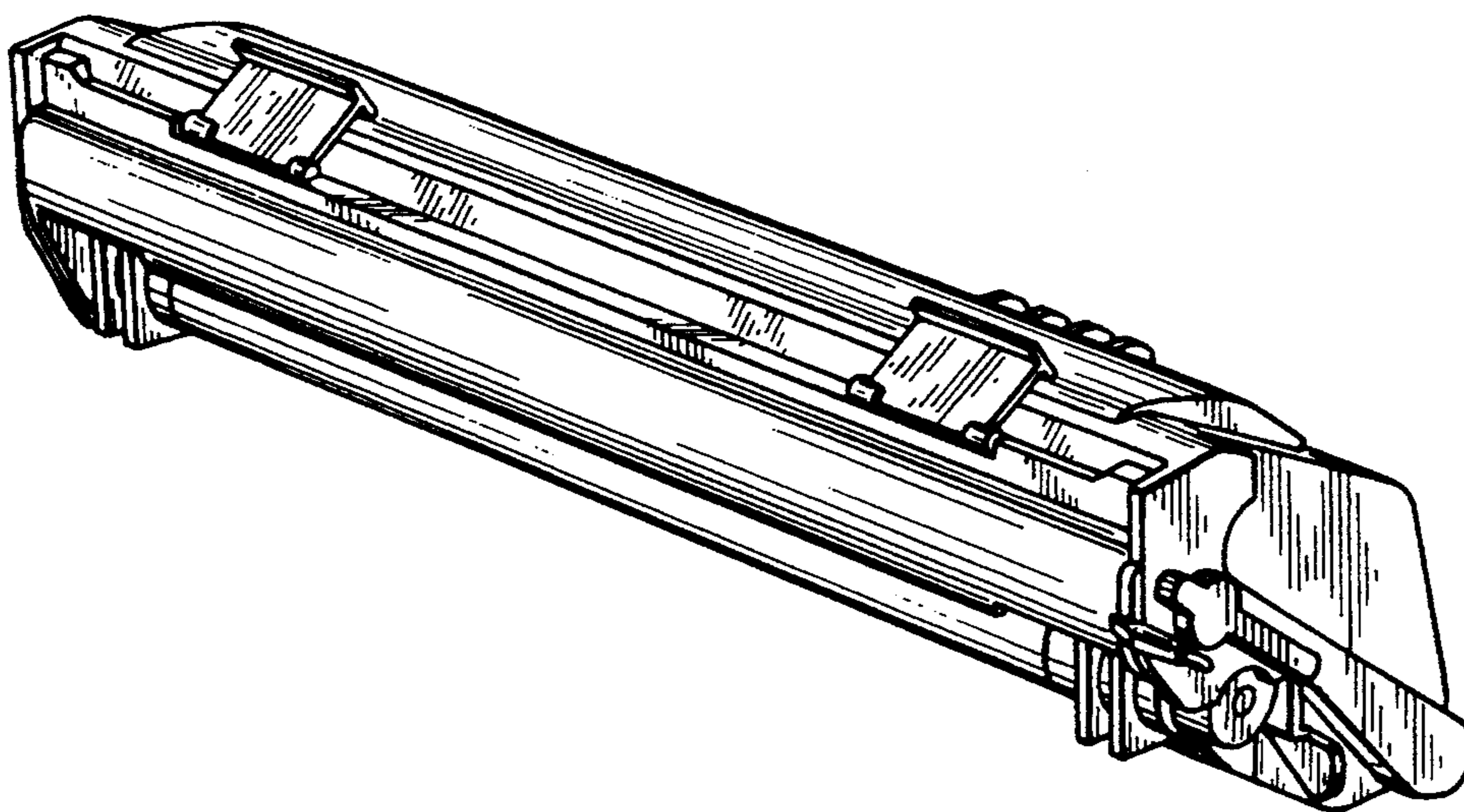

FIG. 1

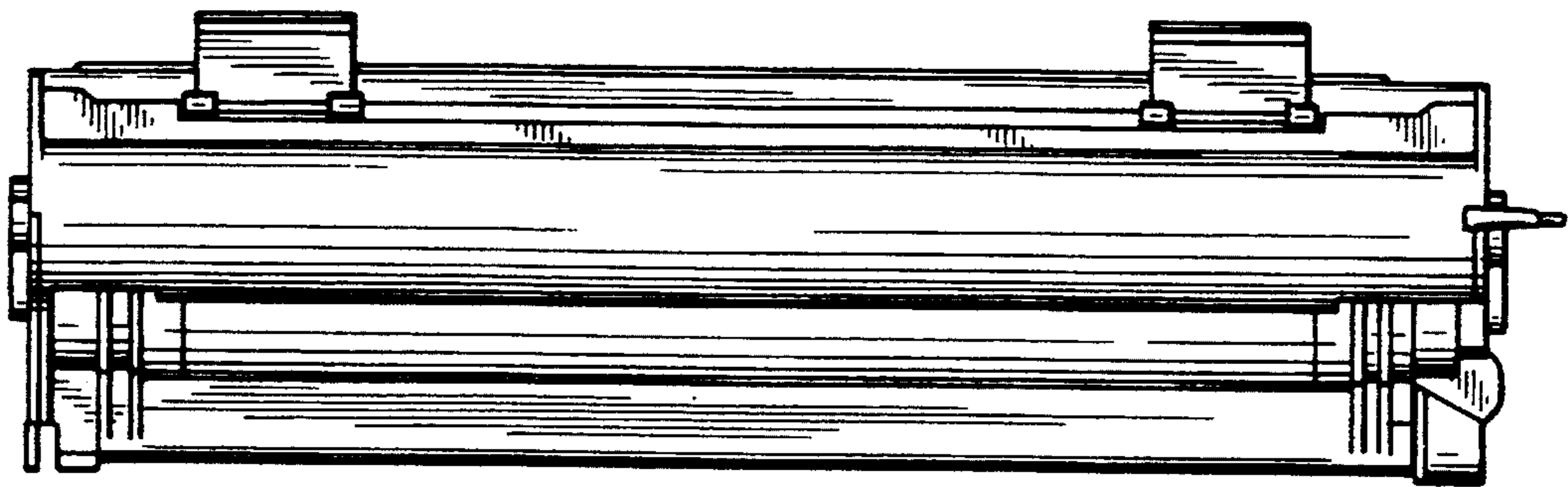

FIG. 2

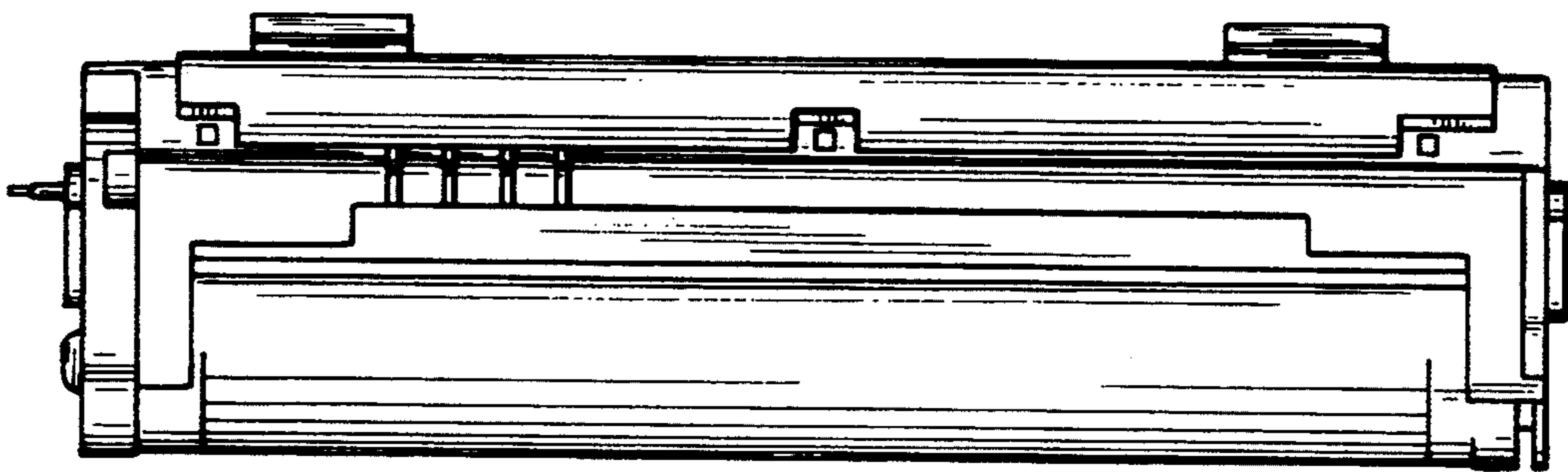

FIG. 3

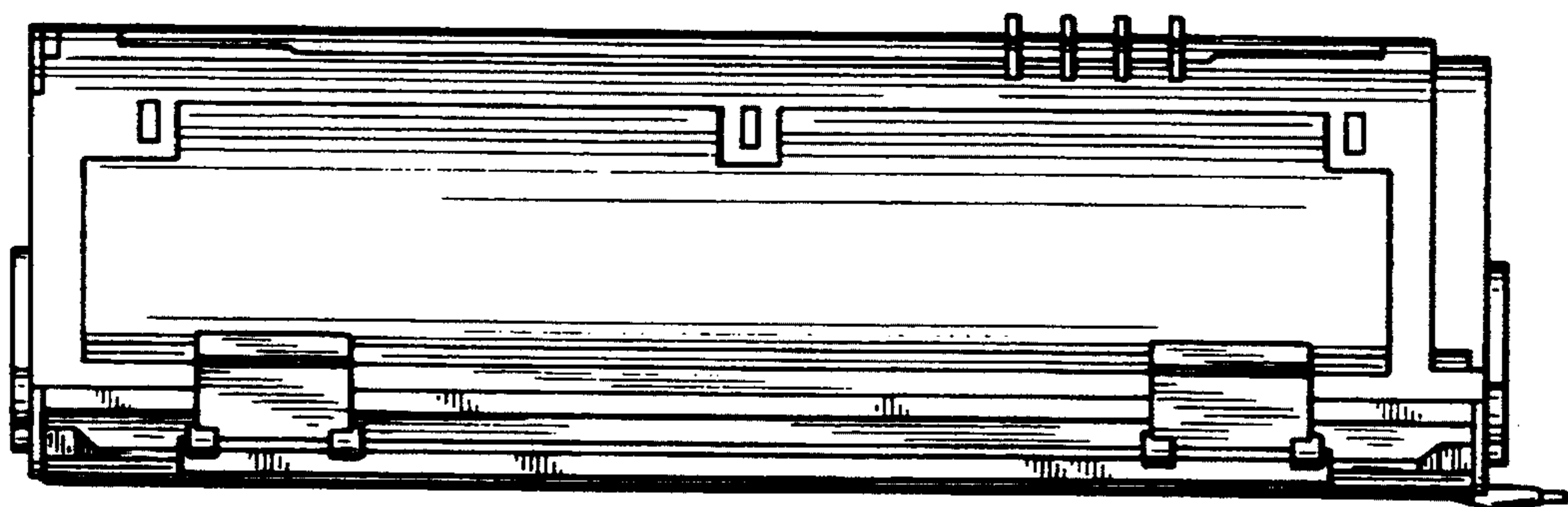

FIG. 4

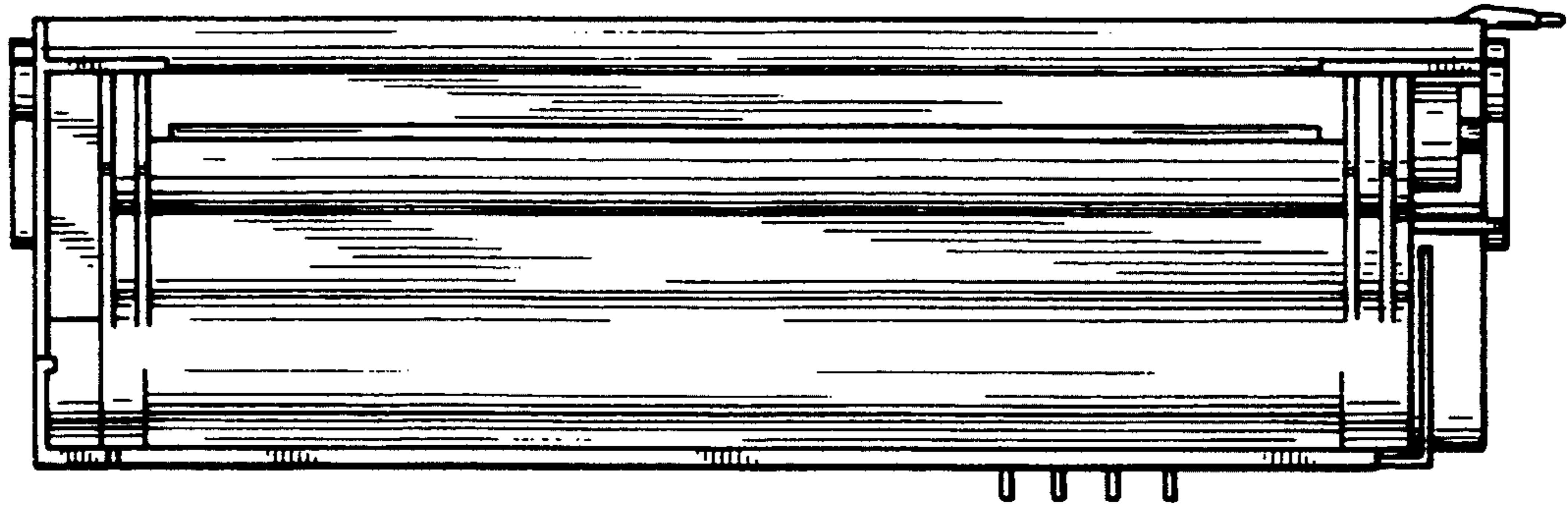

FIG. 5

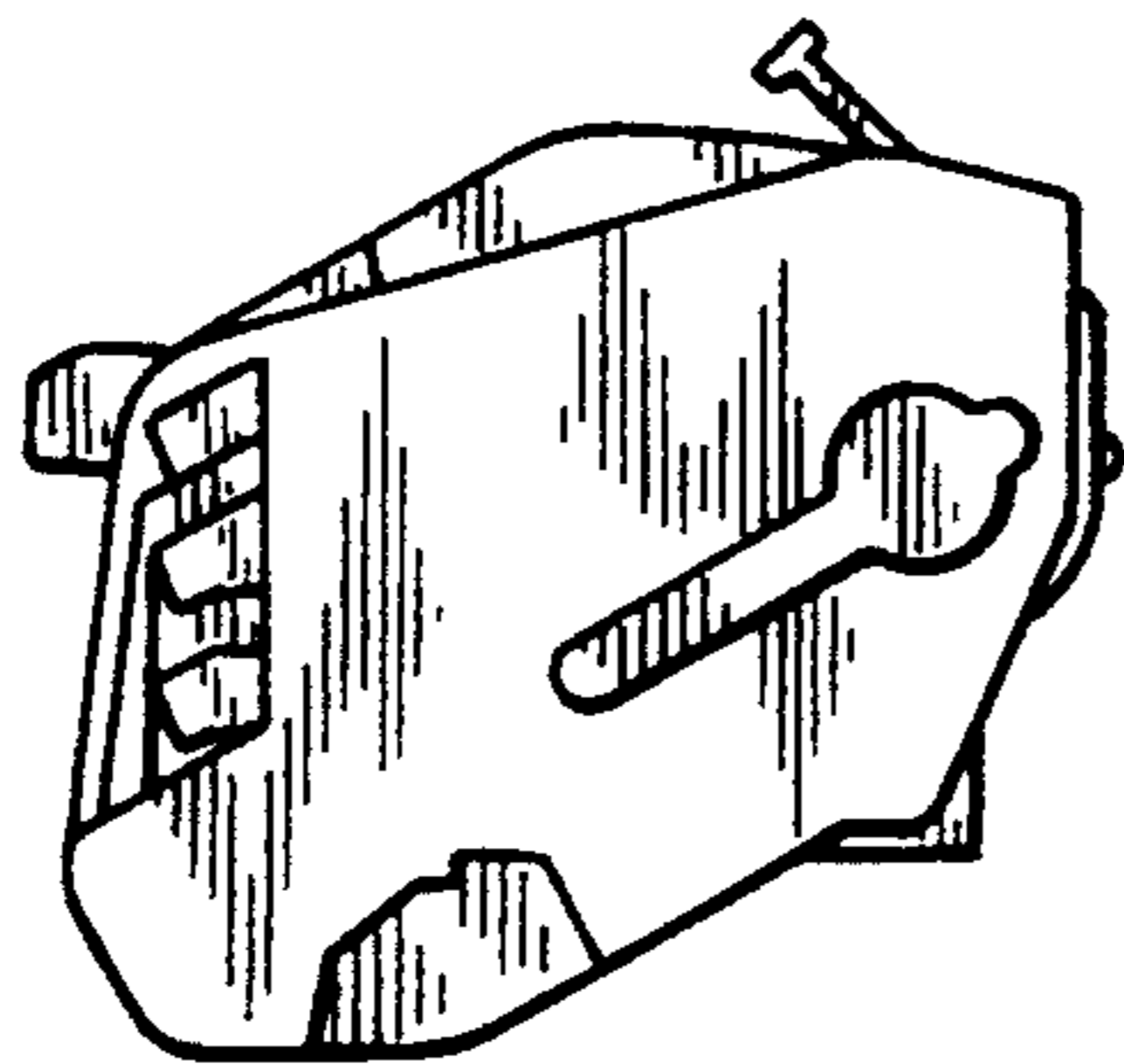

FIG. 6

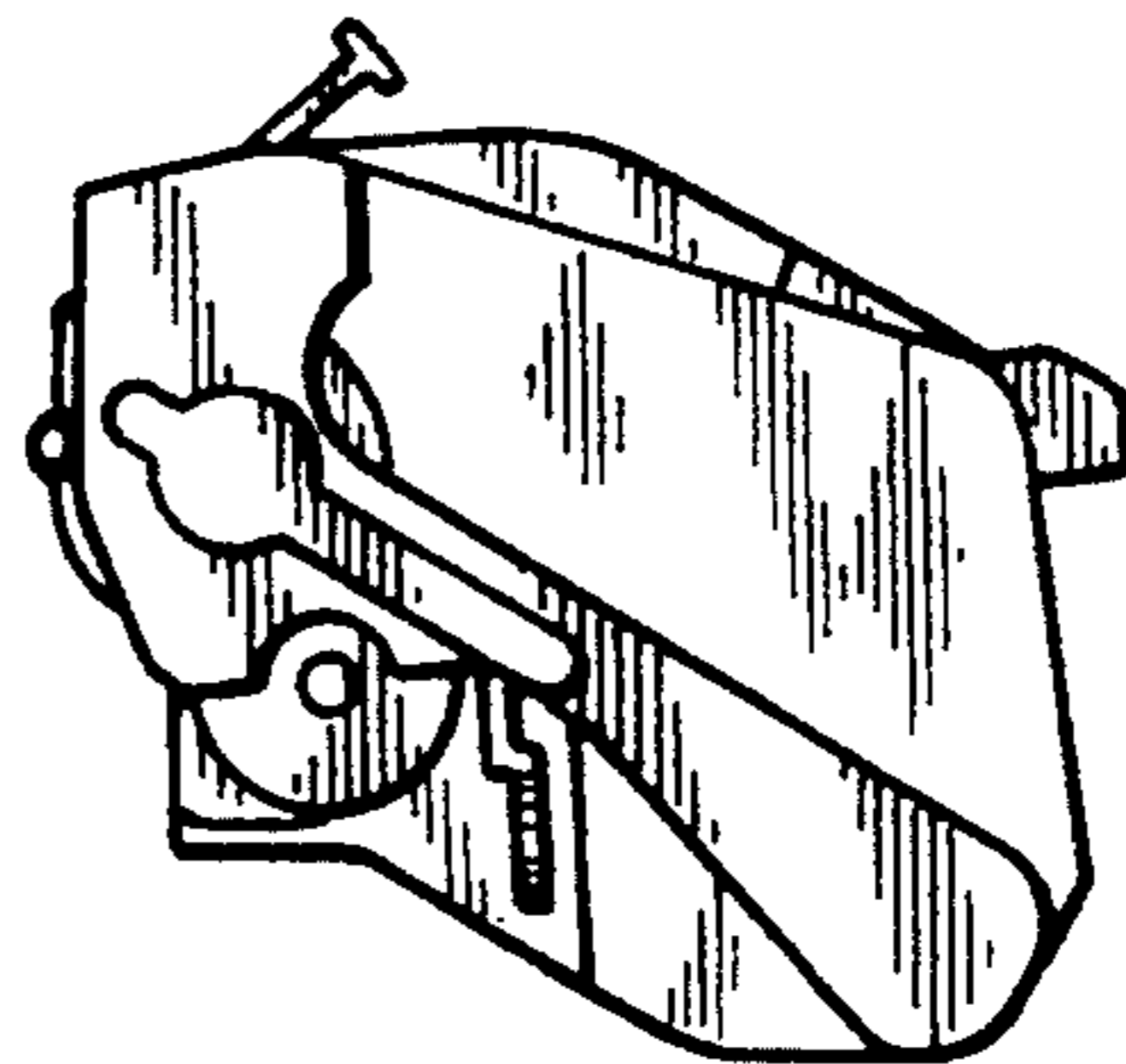

FIG. 7

