



US00D350950S

United States Patent [19]

[11] Patent Number: Des. 350,950

Liu

[45] Date of Patent: ** Sep. 27, 1994

[54] DESK SCANNER

5,173,789 12/1992 Renner et al. D14/116 X

[75] Inventor: Ted Liu, Taoyuan Hsien, Taiwan

OTHER PUBLICATIONS

[73] Assignee: Silitek Corporation, Taipei, Taiwan

Microwarehouse Catalog Item Complete Page Scanner, p. 3a, Jul. 1991.

[**] Term: 14 Years

Primary Examiner—Wallace R. Burke

[21] Appl. No.: 1,545

Assistant Examiner—M. H. Tung

[22] Filed: Nov. 18, 1992

Attorney, Agent, or Firm—Lowe, Price, LeBlanc & Becker

[52] U.S. Cl. D14/116

[57] CLAIM

[58] Field of Search 235/375, 378, 385, 454, 235/462, 472, 486; 354/80-82; 382/58-69; 250/203.1, 216, 566, 568; D14/100, 114, 116; D26/37, 45, 50

The ornamental design for a desk scanner, as shown and described.

[56] References Cited

DESCRIPTION

U.S. PATENT DOCUMENTS

- D. 296,330 6/1988 Davis et al. D14/116
- D. 304,181 10/1989 Kagayama et al. D14/116
- D. 314,951 2/1991 Swartz D14/116 X
- 5,063,508 11/1991 Yamada et al. D14/116 X

- FIG. 1 is a perspective view thereof;
- FIG. 2 is a front view thereof;
- FIG. 3 is a rear view thereof;
- FIG. 4 is a right side view thereof;
- FIG. 5 is a left side view thereof;
- FIG. 6 is a top view thereof; and,
- FIG. 7 is a bottom view thereof.

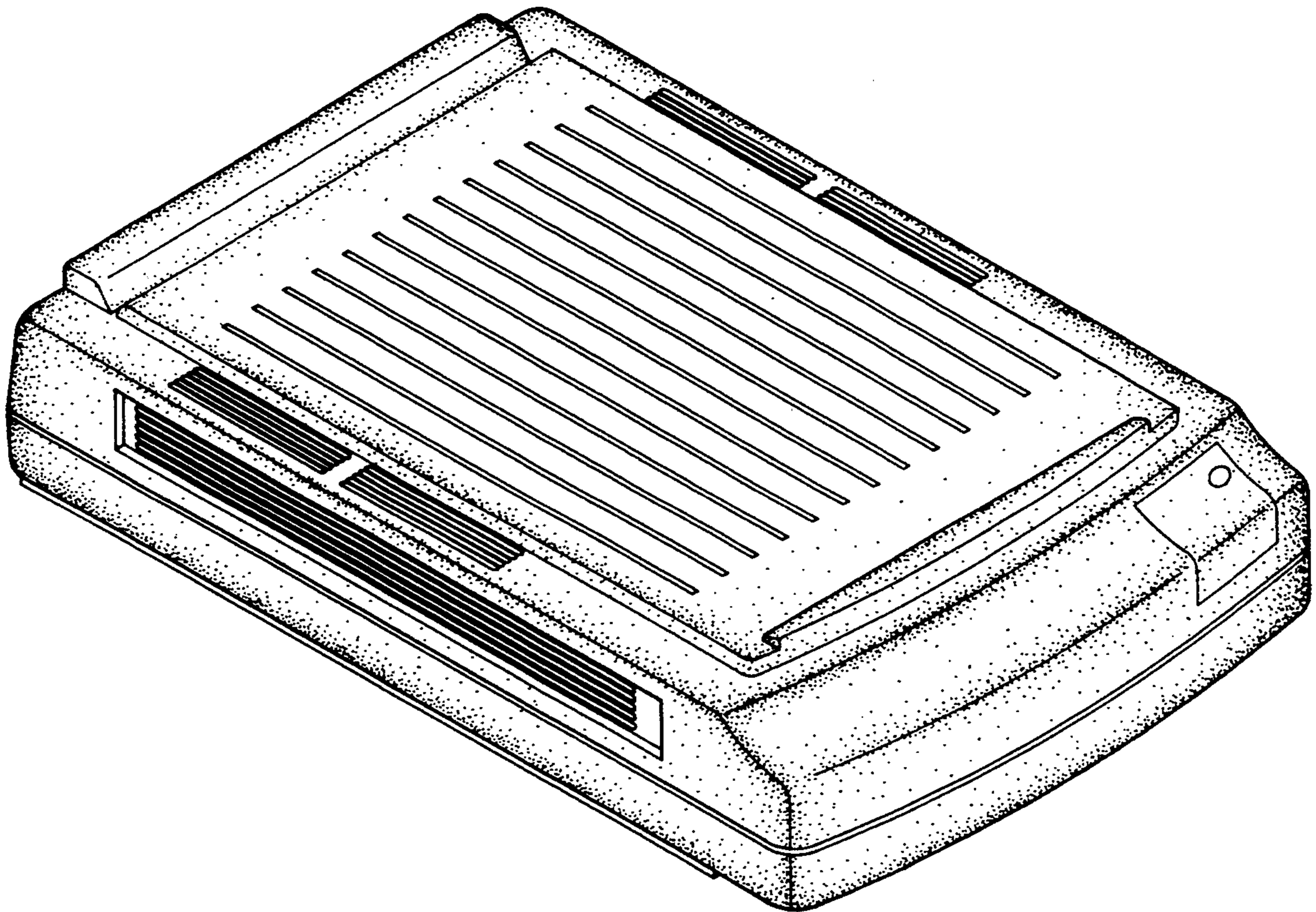

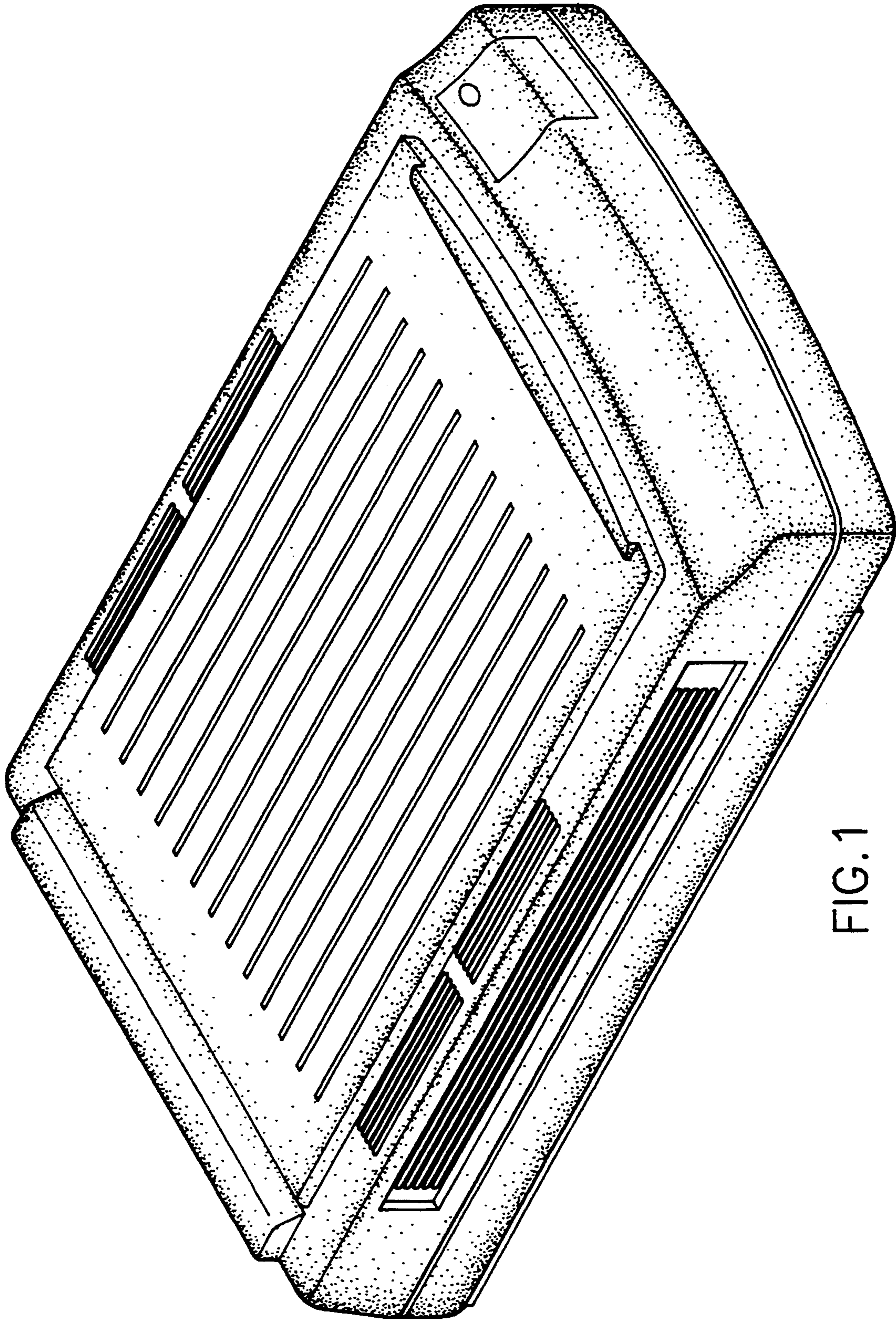

FIG. 1

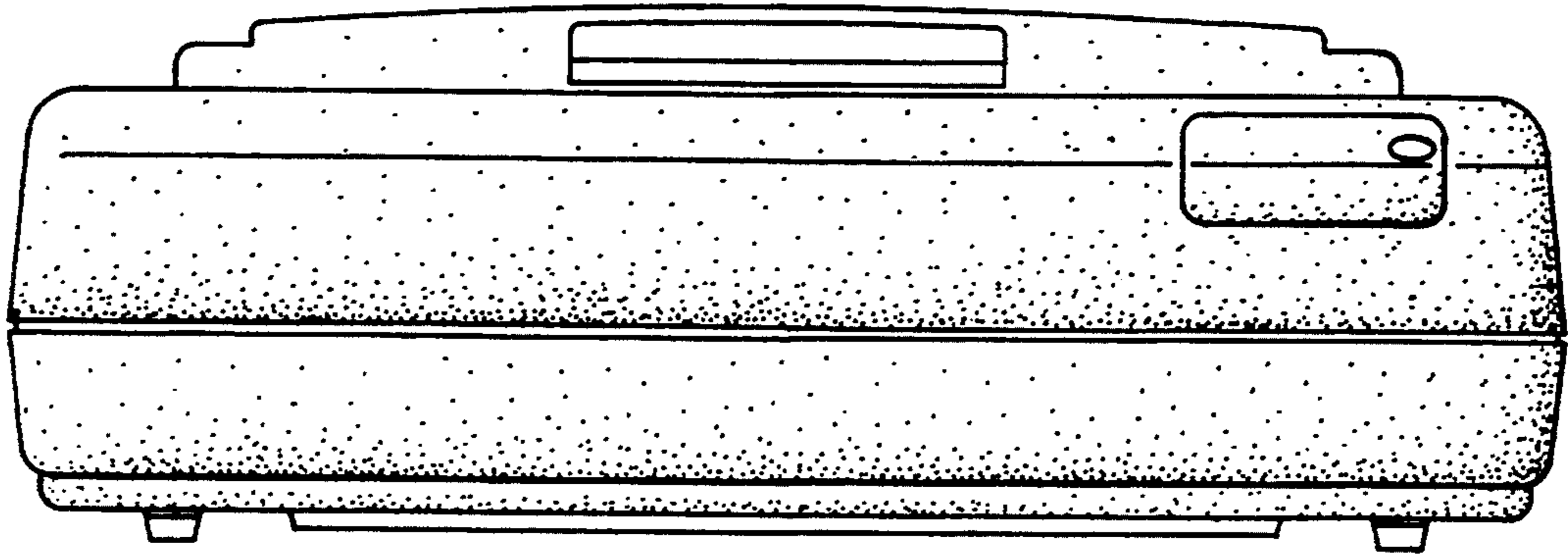

FIG. 2

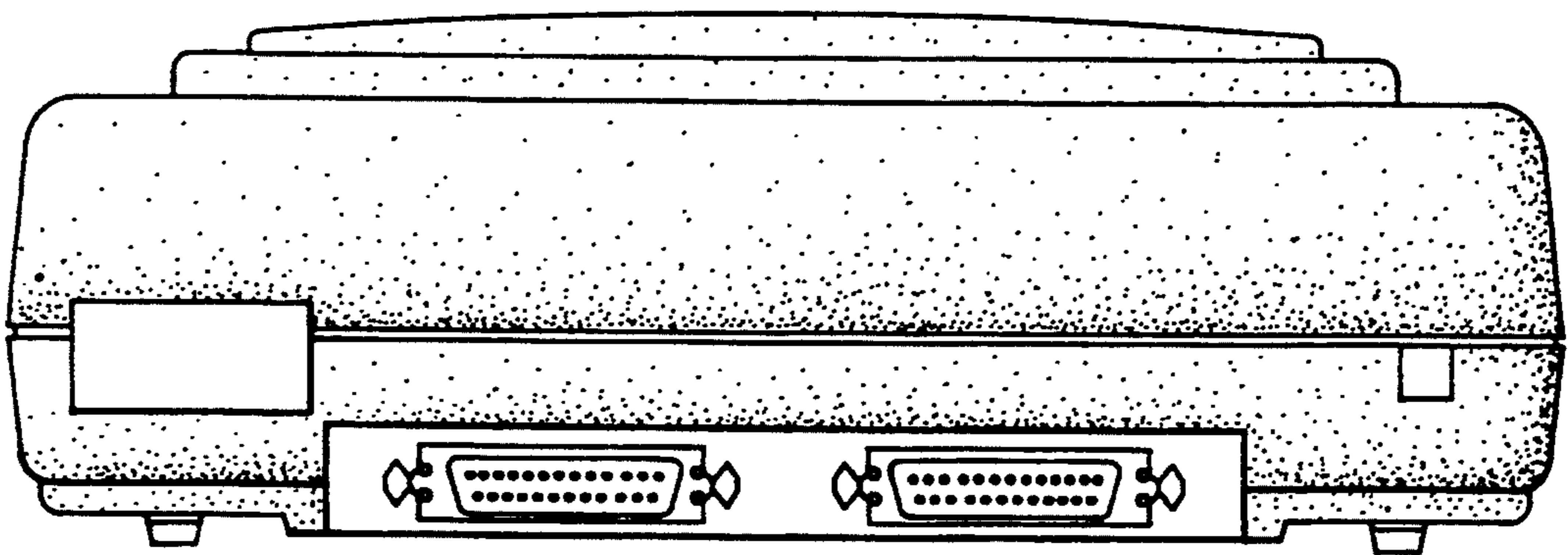

FIG. 3

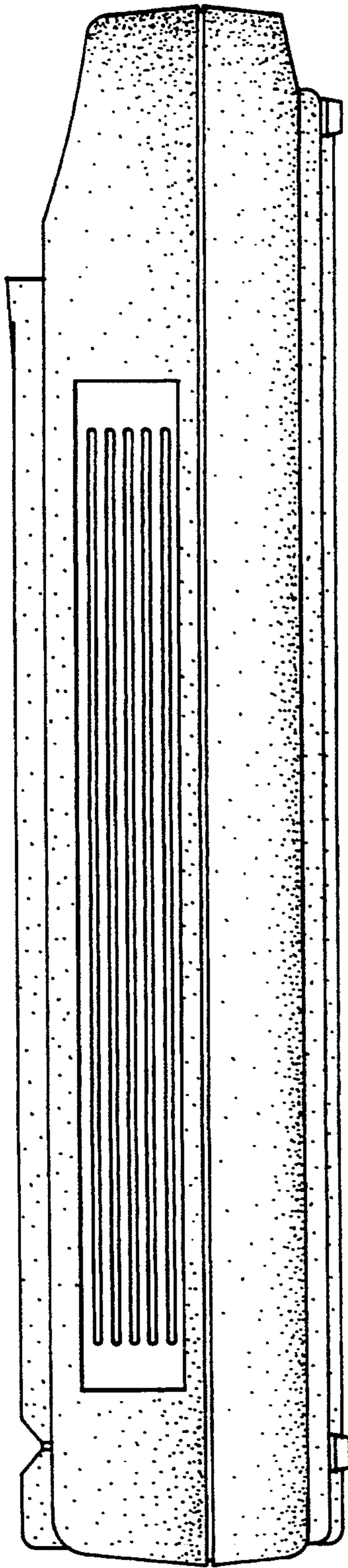

FIG. 4

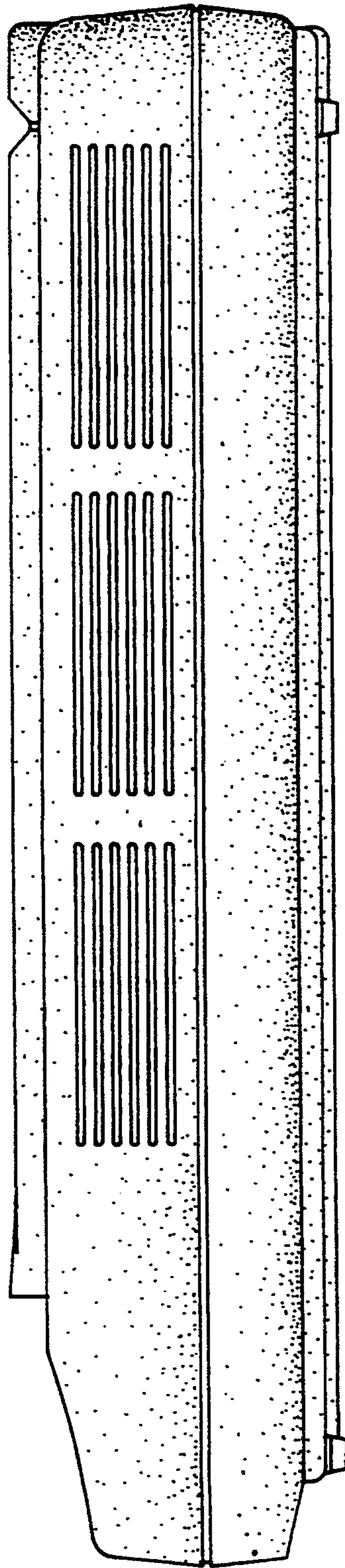

FIG. 5

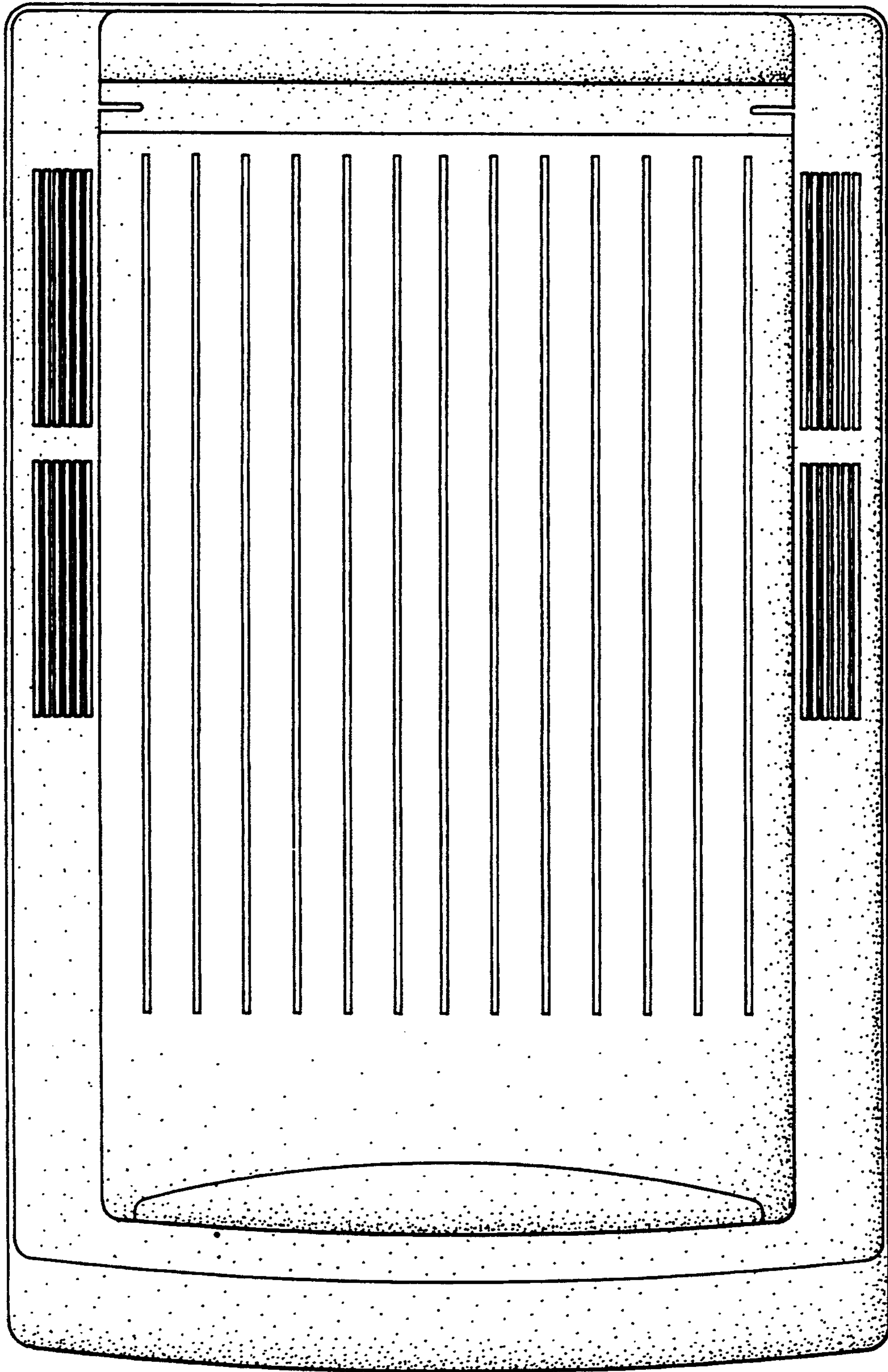

FIG. 6

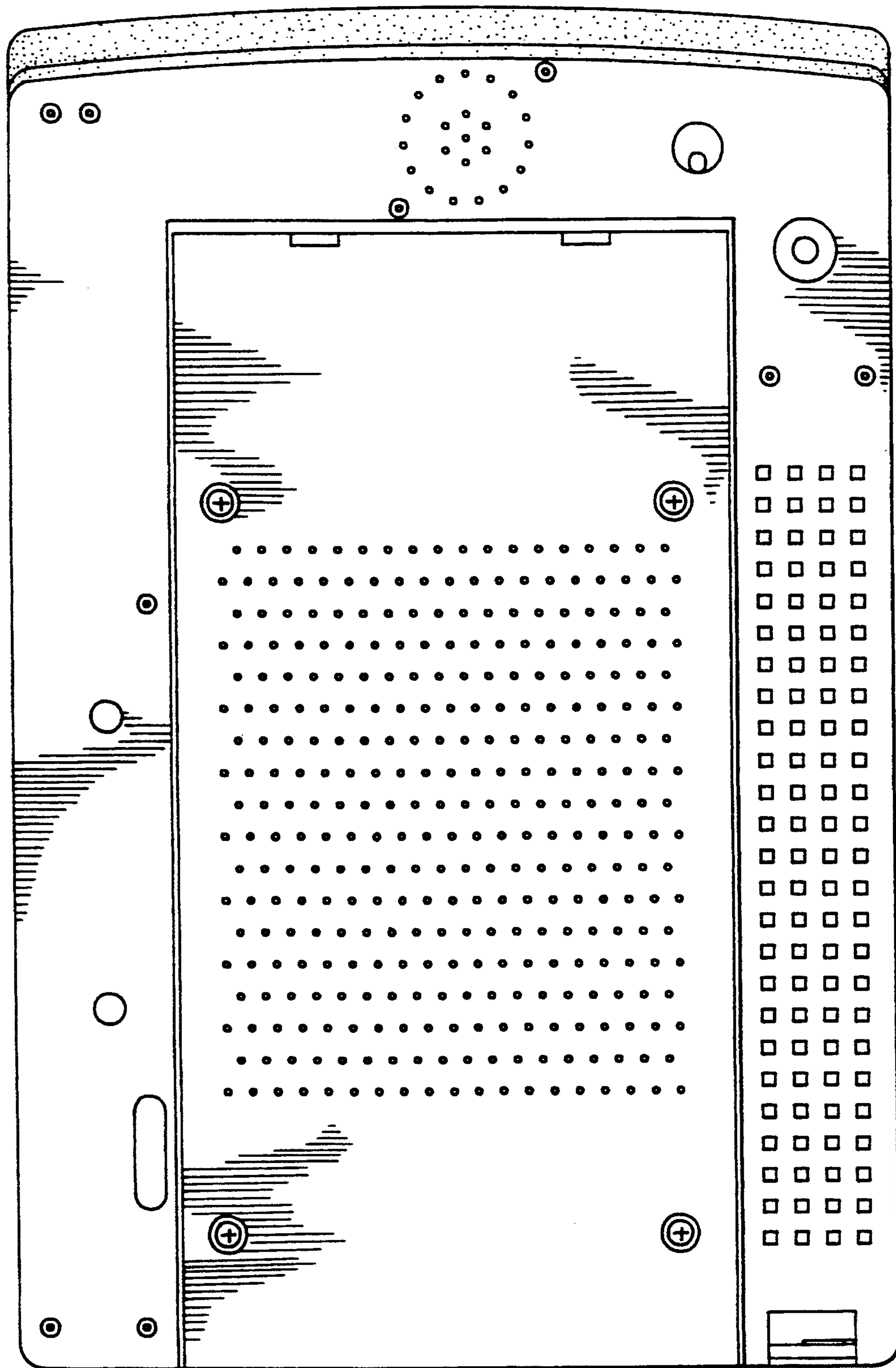

FIG. 7