



US00D350603S

# United States Patent [19]

[11] Patent Number: **Des. 350,603**

**Firlik**

[45] Date of Patent: **\*\* Sep. 13, 1994**

## [54] CELL CULTURE SCRAPER

- [75] Inventor: **Jerome T. Firlik, Oneonta, N.Y.**
- [73] Assignee: **Corning Incorporated, Corning, N.Y.**
- [\*\*] Term: **14 Years**
- [21] Appl. No.: **784,039**

- [22] Filed: **Oct. 28, 1991**
- [52] U.S. Cl. .... **D24/119; D8/11; D32/46**
- [58] Field of Search ..... **128/757; 435/292, 295; 422/100, 102; D8/11, 9, 1; D24/119; D32/46, 49**

## [56] References Cited

### U.S. PATENT DOCUMENTS

D. 240,794	8/1976	Mary	.....	D32/49	X
D. 251,013	2/1979	Kettel	.....	D24/149	
D. 271,519	11/1983	Baitz	.....	D24/119	
D. 274,464	6/1984	Baitz	.....	D24/119	
D. 304,892	12/1989	Bevilacqua	.....	D32/46	X
D. 317,854	7/1991	Pifalo	.....	D8/11	
D. 322,316	12/1991	Wong	.....	D24/119	
52,079	1/1866	Rogers	.....	D8/11	X
1,422,773	7/1992	McCarthy	.....	15/236.5	X
1,477,653	12/1923	Barre	.....	30/169	X
2,253,116	8/1941	Findlay	.....	D8/9	X
2,747,911	5/1956	Kuever	.....	15/236.7	X
2,824,323	2/1958	Tos et al.	.....	15/236.5	X
3,345,669	10/1967	Starry	.....	D24/119	X
4,687,746	8/1987	Rosenberg et al.	.....	D24/119	X
4,892,831	1/1990	Wong	.....	128/759	X

## OTHER PUBLICATIONS

- The Fisher Catalog 1991/1992 "Cell Scrapers" p. 1563 ©1990.
- Union Fork and Hoe Co Catalog "Rakes and Hoes" Dec. 4, 1986, p. 30.
- Primary Examiner—A. Hugo Word
- Assistant Examiner—I. Simmons
- Attorney, Agent, or Firm—Brian R. Leslie

## [57] CLAIM

The ornamental design is a cell culture scraper, as shown and described.

## DESCRIPTION

FIG. 1 is a side view of the disclosed cell culture scraper, shown in a section broken away for ease of illustration;

FIG. 2 is a front view of the disclosed cell culture scraper;

FIG. 3 is a cross-sectional view of the disclosed cell culture scraper taken along the line 3—3 of FIG. 1;

FIG. 4 is a cross-sectional view of the disclosed cell culture scraper taken along the line 4—4 of FIG. 1;

FIG. 5 is a cross-sectional view of the disclosed cell culture scraper taken along the line 5—5 of FIG. 1;

FIG. 6 is an enlarged fragmented side view of the tip portion of the disclosed cell culture scraper, with the scraper portion removed;

FIG. 7 is a top view of the disclosed cell culture scraper, shown with a section broken away for ease of illustration;

FIG. 8 is a bottom view of the disclosed cell culture scraper, shown with a section broken away for ease of illustration; and,

FIG. 9 is a rear view of the disclosed cell culture scraper.

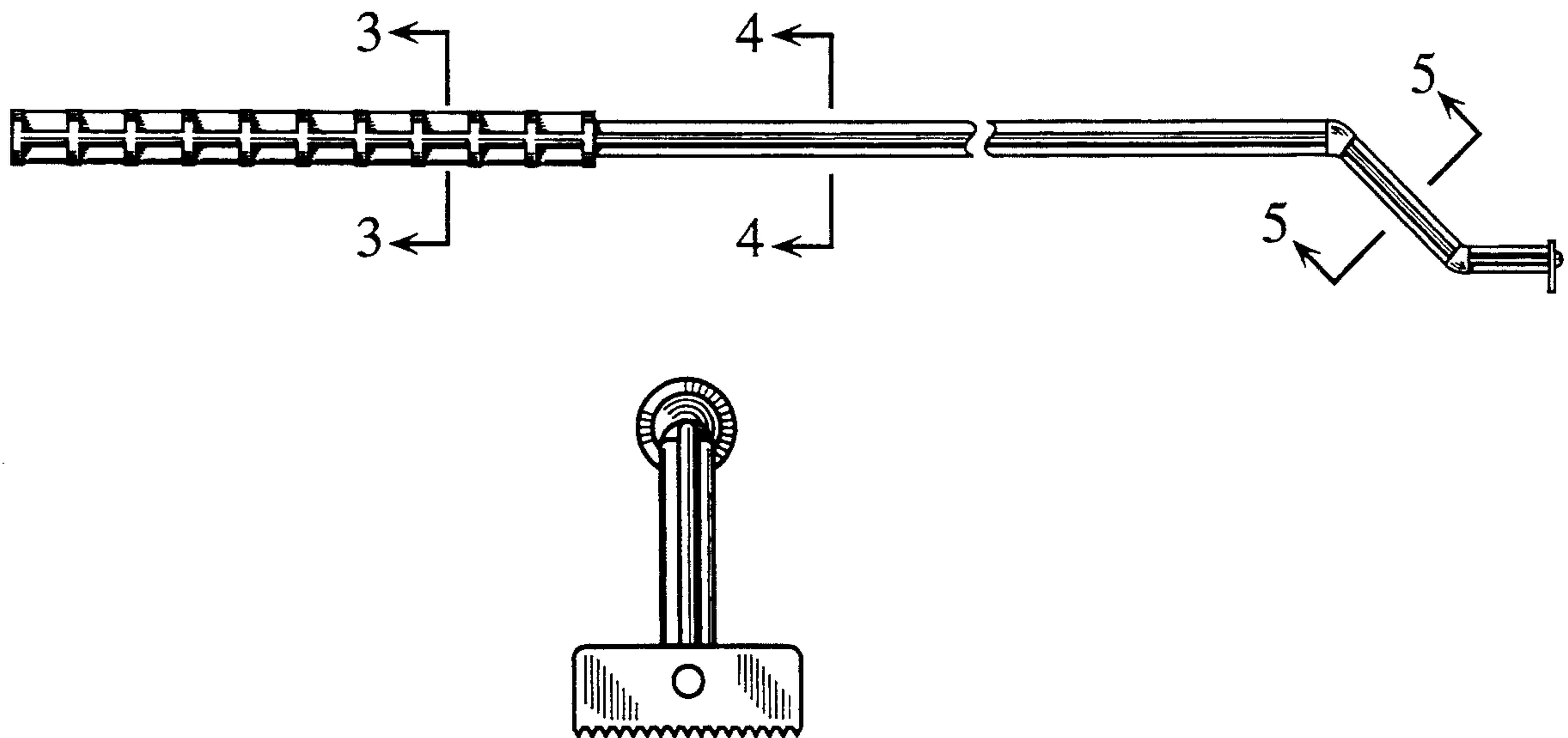

FIG. 7

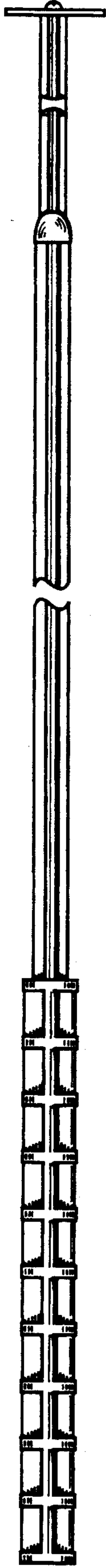

FIG. 1

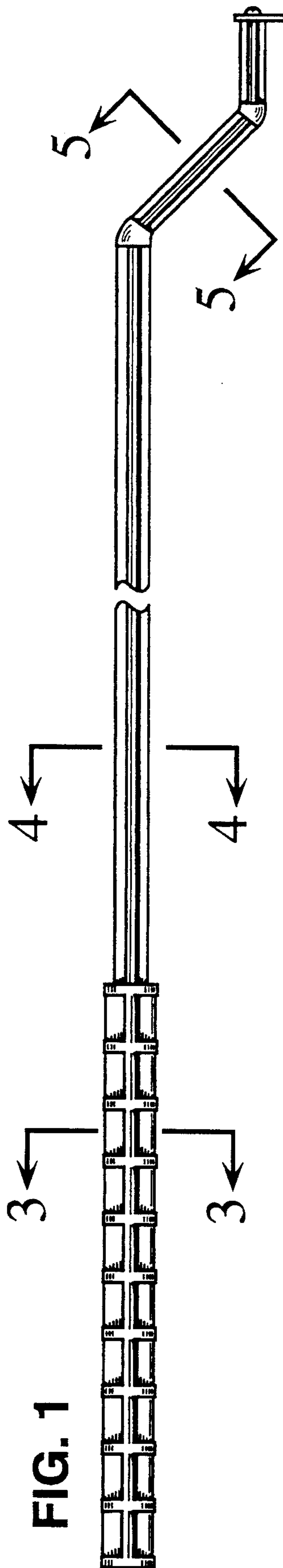

FIG. 8

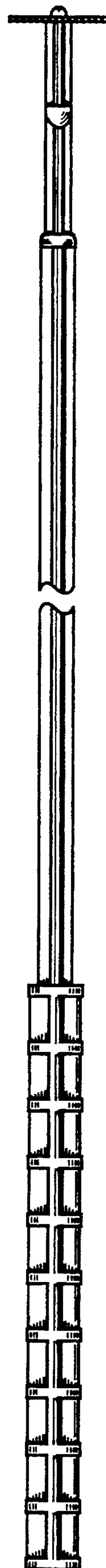

FIG. 3

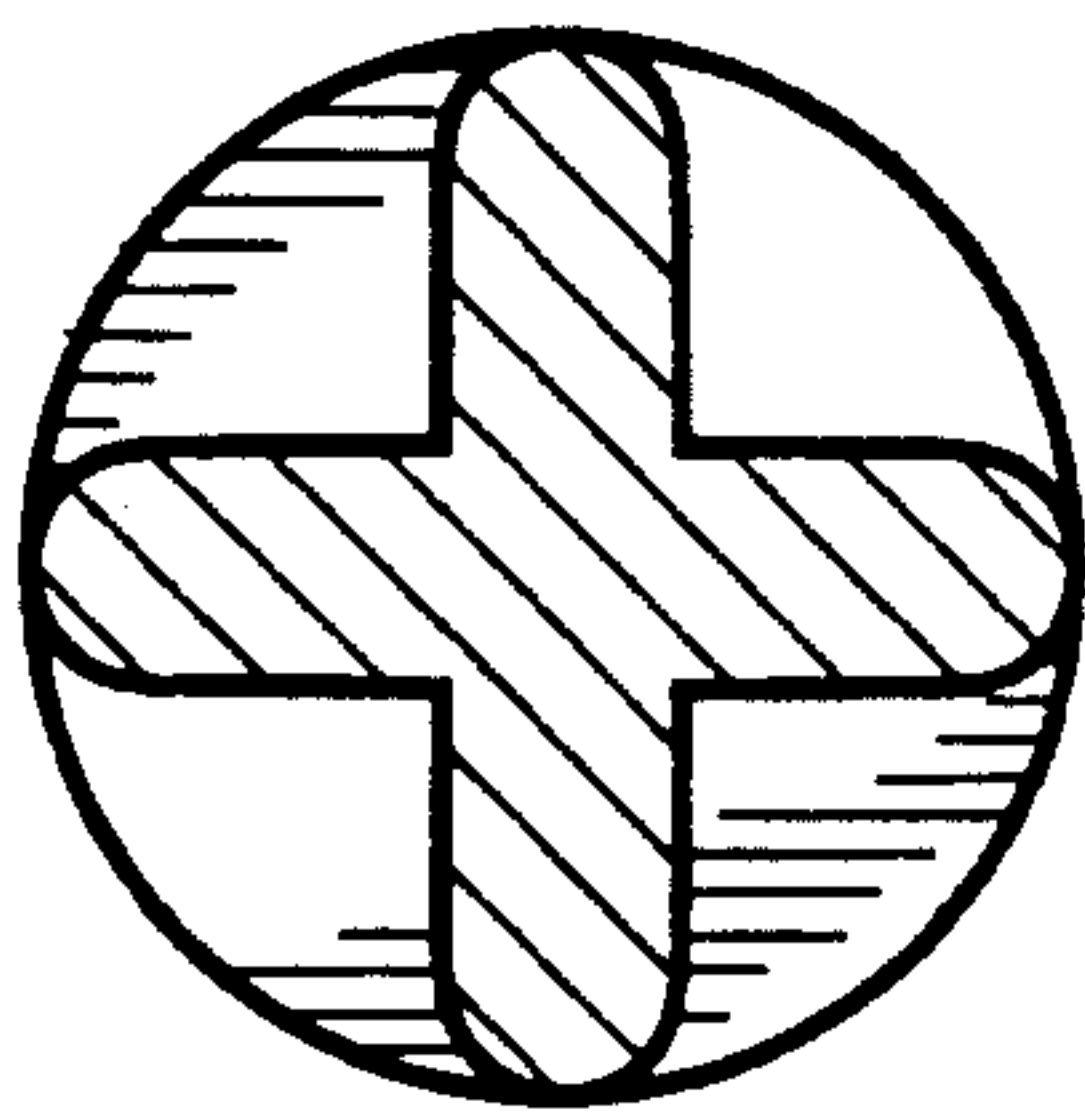

FIG. 4

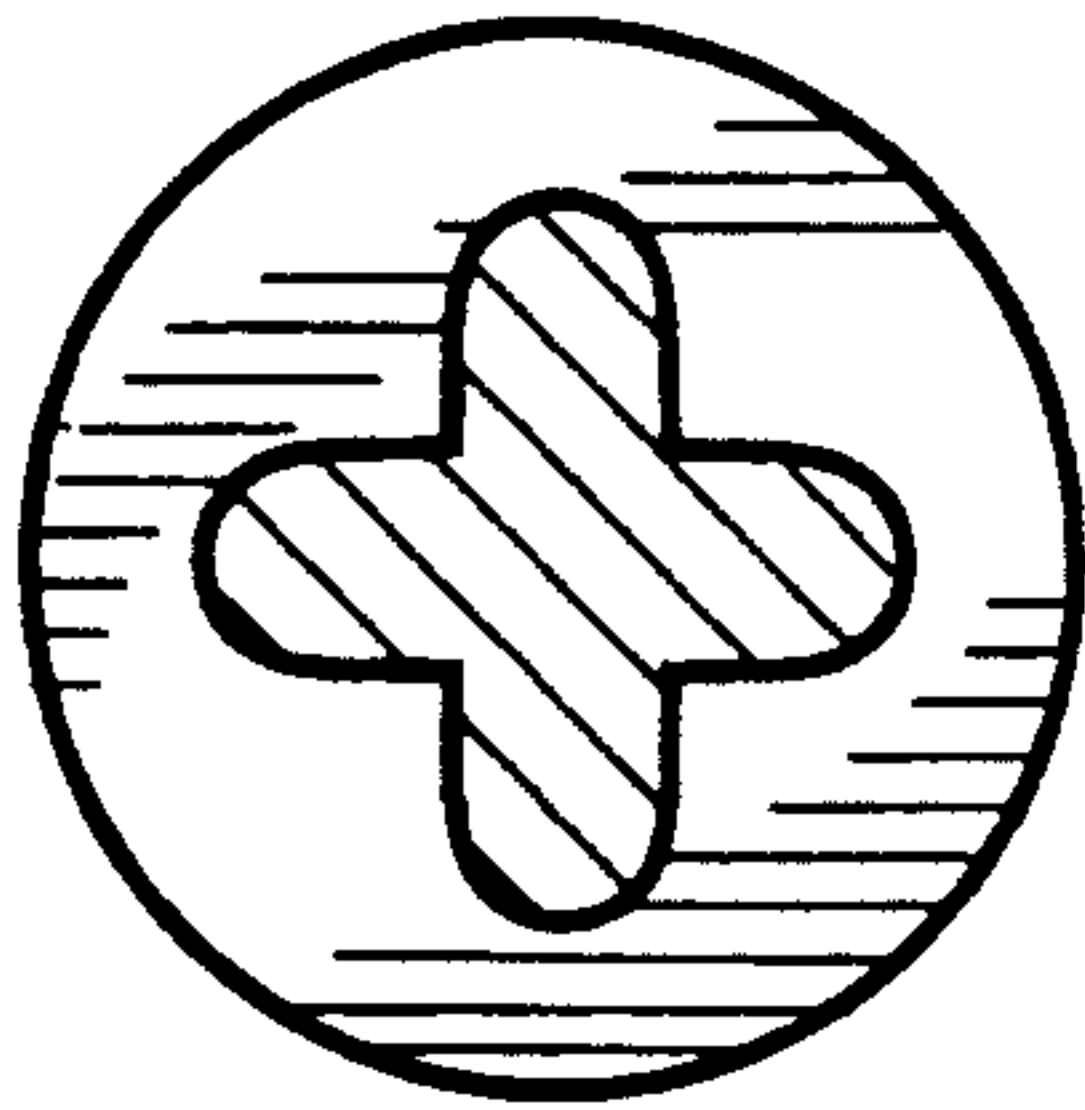

FIG. 5



FIG. 6

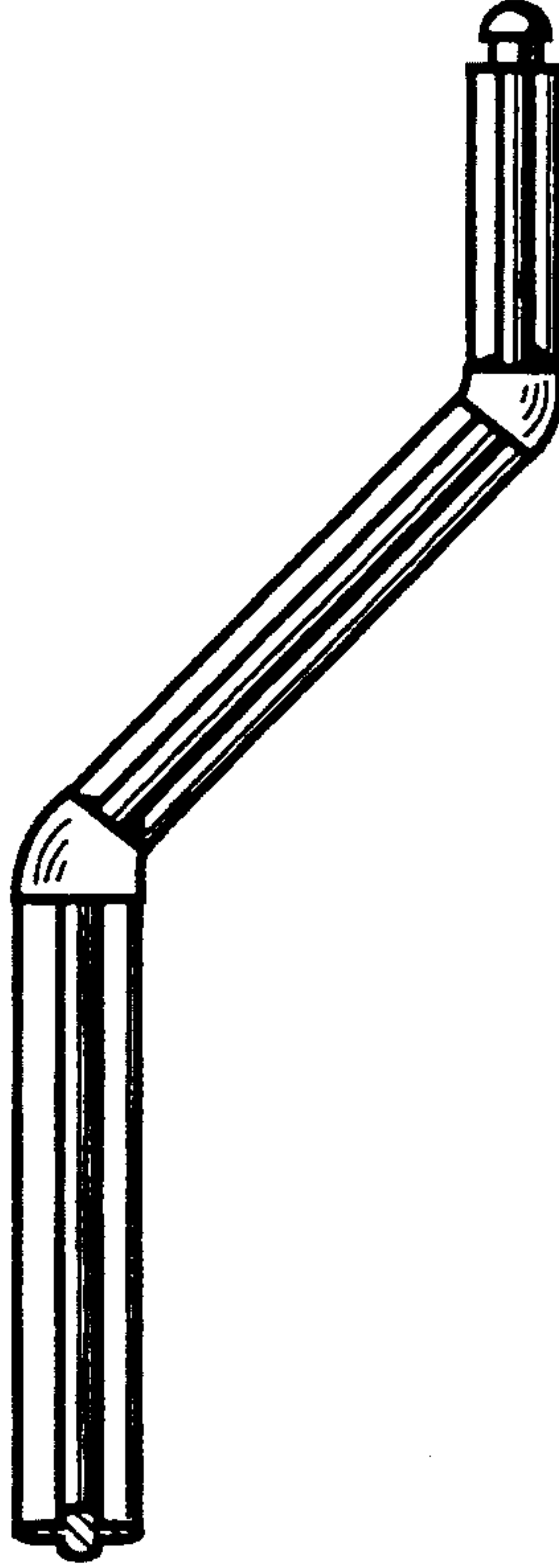

FIG. 2

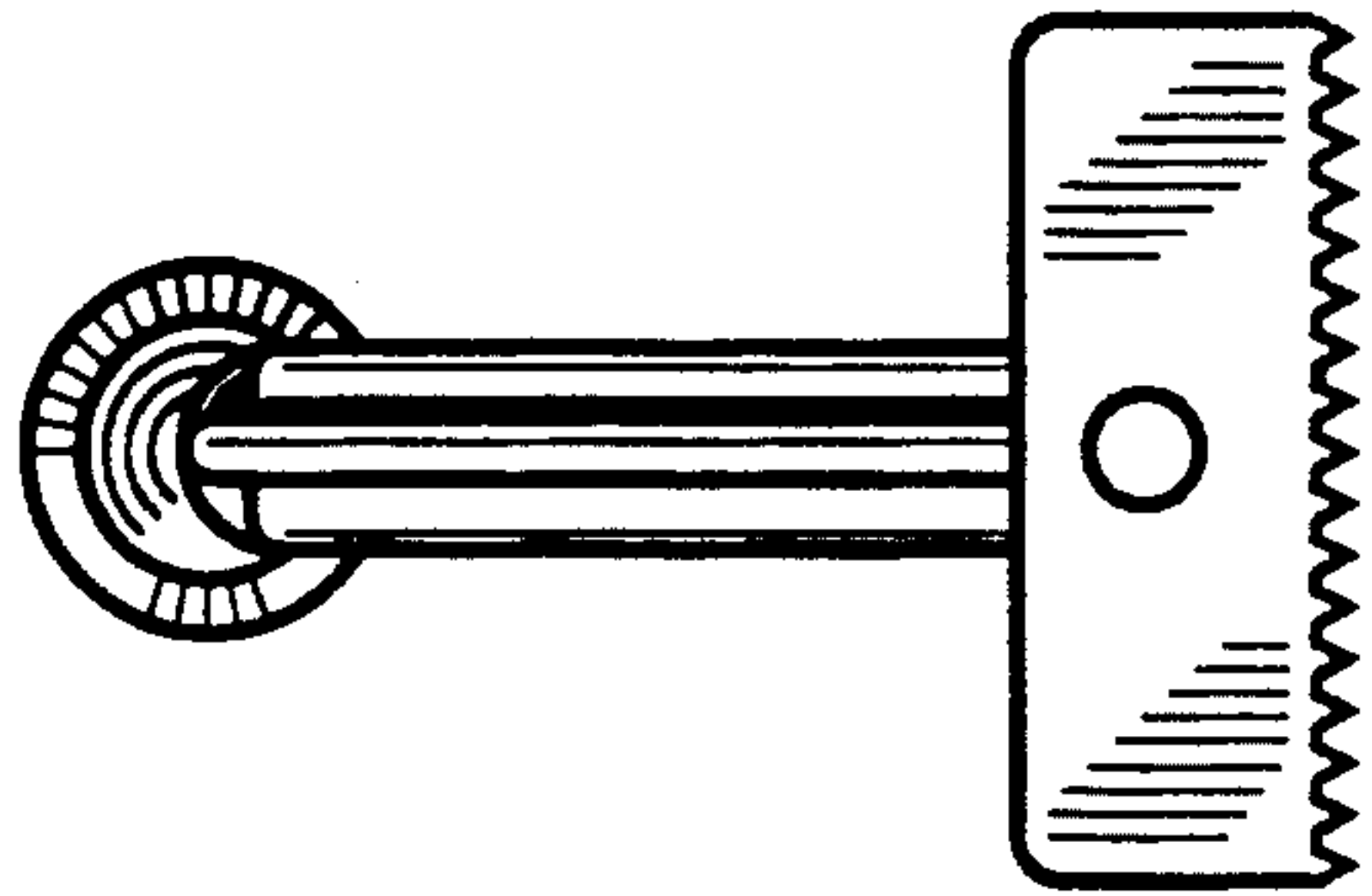

FIG. 9

