



US00D350590S

# United States Patent [19]

[11] Patent Number: **Des. 350,590**

Fischer

[45] Date of Patent: **\*\* Sep. 13, 1994**

[54] **AUTOMATIC FAUCET**

[75] Inventor: **Gerhard Fischer**, Campione, Switzerland

[73] Assignee: **Cosmos Entwicklungs- und Forschungsanstalt**, Vaduz, Liechtenstein

[\*\*] Term: **14 Years**

[21] Appl. No.: **56**

[22] Filed: **Sep. 30, 1992**

[30] **Foreign Application Priority Data**

Apr. 2, 1992 [DE] Fed. Rep. of Germany ..... 9202708

[52] U.S. Cl. .... **D23/238**

[58] Field of Search ..... 4/623, 675-678; 137/216, 606, 625.17, 801; D23/238-243

[56] **References Cited**

**U.S. PATENT DOCUMENTS**

- D. 205,253 7/1966 Russell ..... D23/238
- D. 220,101 3/1971 Brown et al. .... D23/238
- D. 227,761 7/1973 Arbon ..... D23/238
- D. 313,464 1/1991 Di Maggio ..... D23/238

- D. 325,771 4/1992 Di Maggio ..... D23/238
- D. 339,628 9/1993 Jans ..... D23/238
- D. 341,873 11/1993 Allen et al. .... D23/238
- 3,415,280 12/1968 Bucknell et al. .... 137/625.17
- 3,974,858 8/1976 Nielsen ..... 137/606
- 4,762,273 8/1988 Gregory et al. .... 4/623
- 4,767,922 8/1988 Stauffer ..... 4/623 X
- 4,894,874 1/1990 Wilson ..... 4/623
- 4,953,236 9/1990 Lee et al. .... 4/623

*Primary Examiner*—James R. Largen  
*Attorney, Agent, or Firm*—Robert W. Becker & Associates

[57] **CLAIM**

The ornamental design of a automatic faucet, as shown and described.

**DESCRIPTION**

FIG. 1 is a front view of a automatic faucet showing my new design;  
FIG. 2 is a right side view thereof;  
FIG. 3 is a left side view thereof;  
FIG. 4 is a rear view thereof;  
FIG. 5 is a top view thereof; and,  
FIG. 6 is a bottom view thereof.

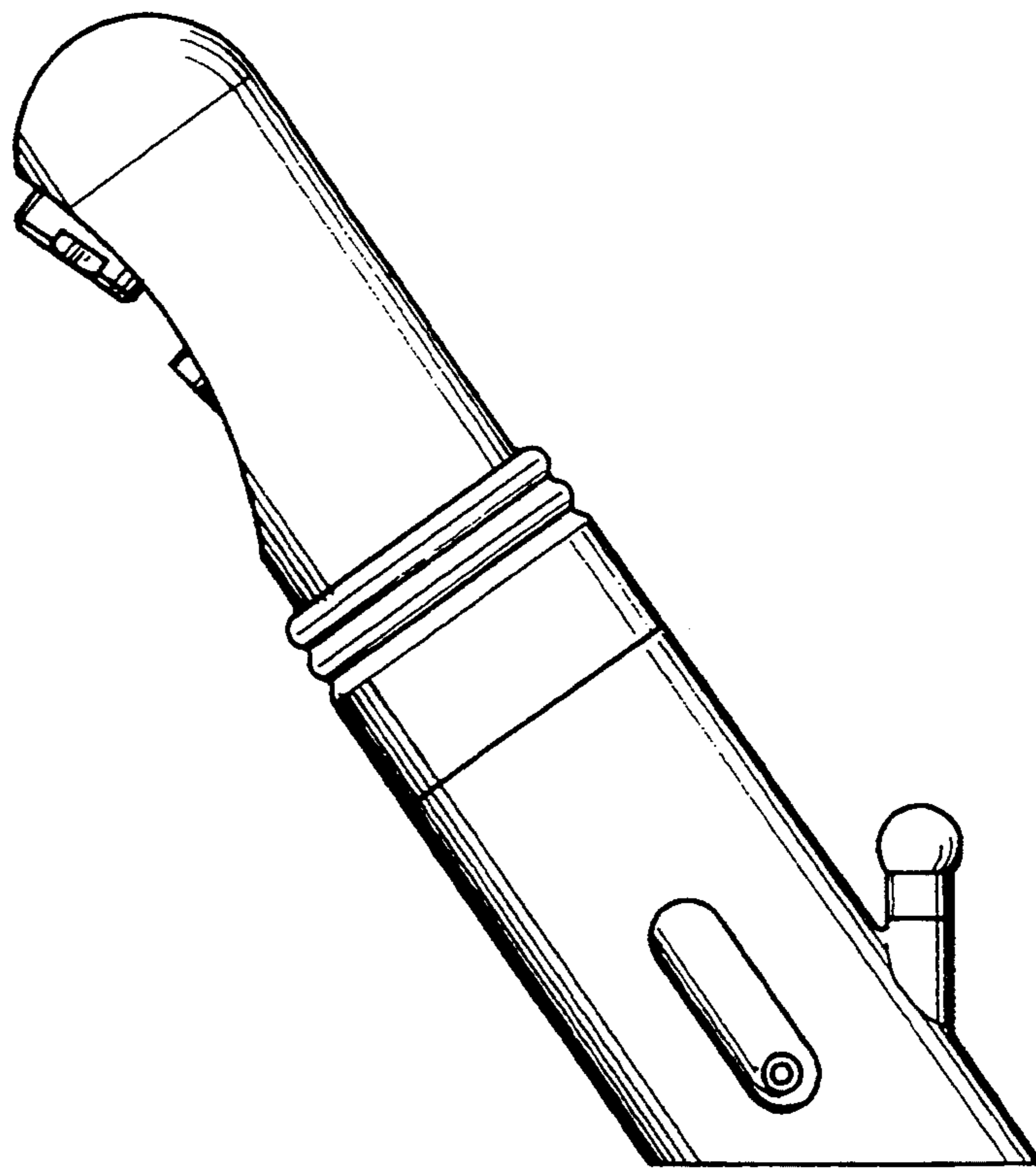
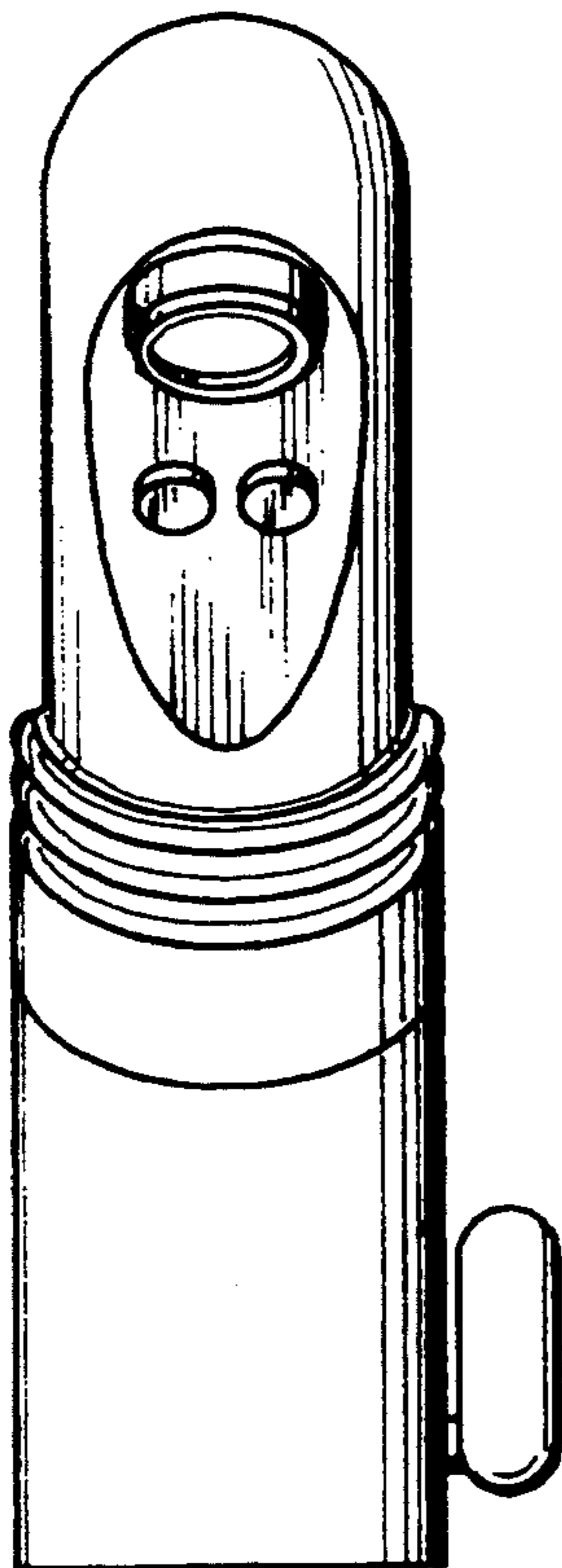

Fig. 1

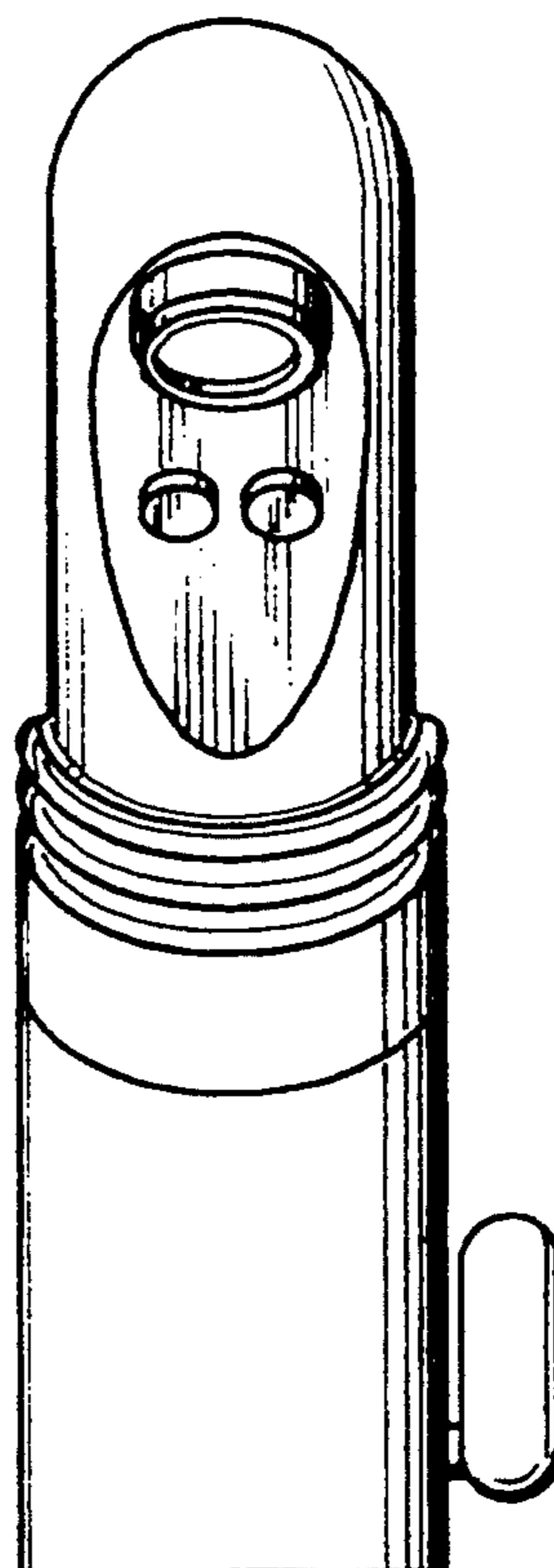

Fig. 2

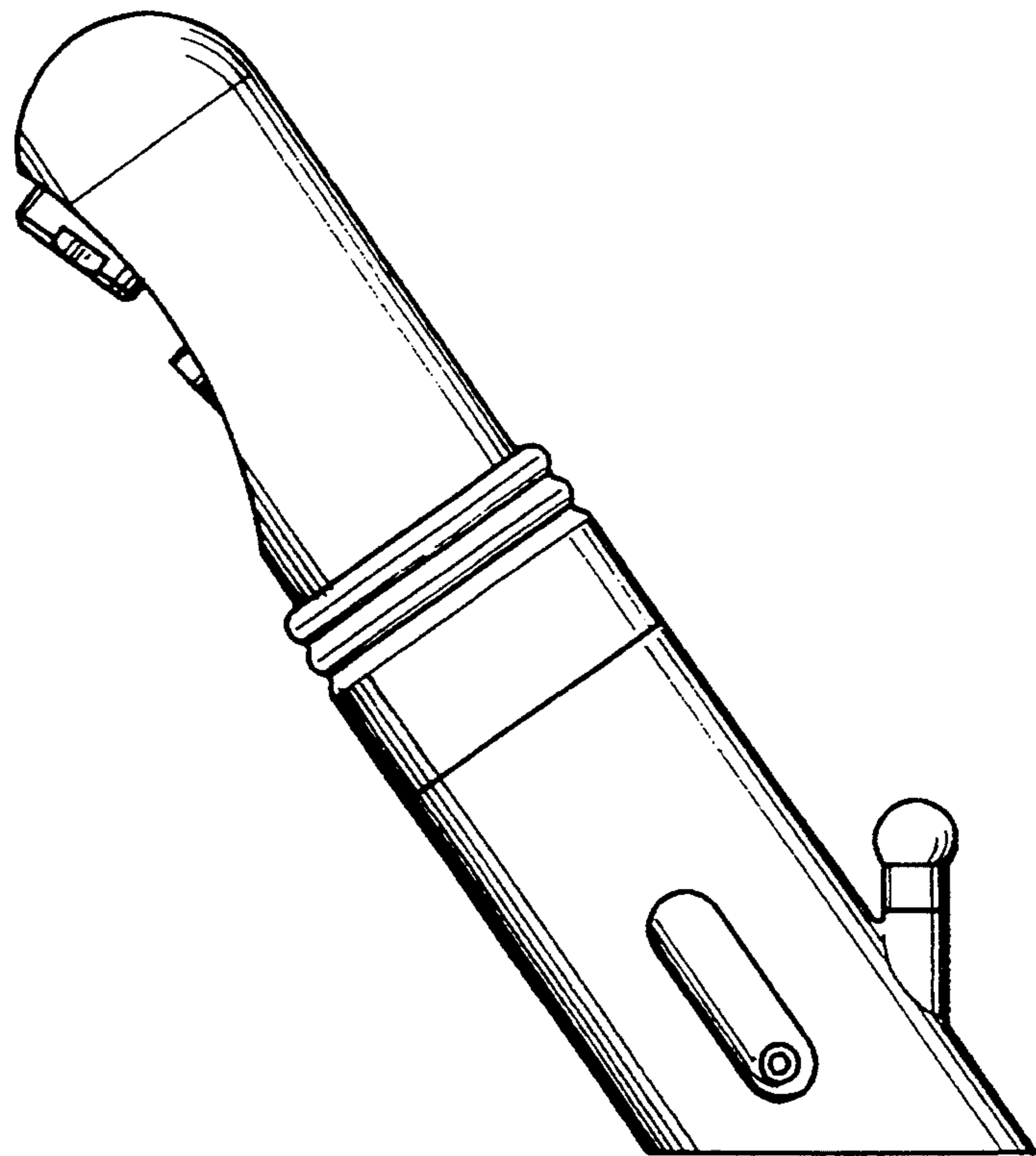

Fig. 3

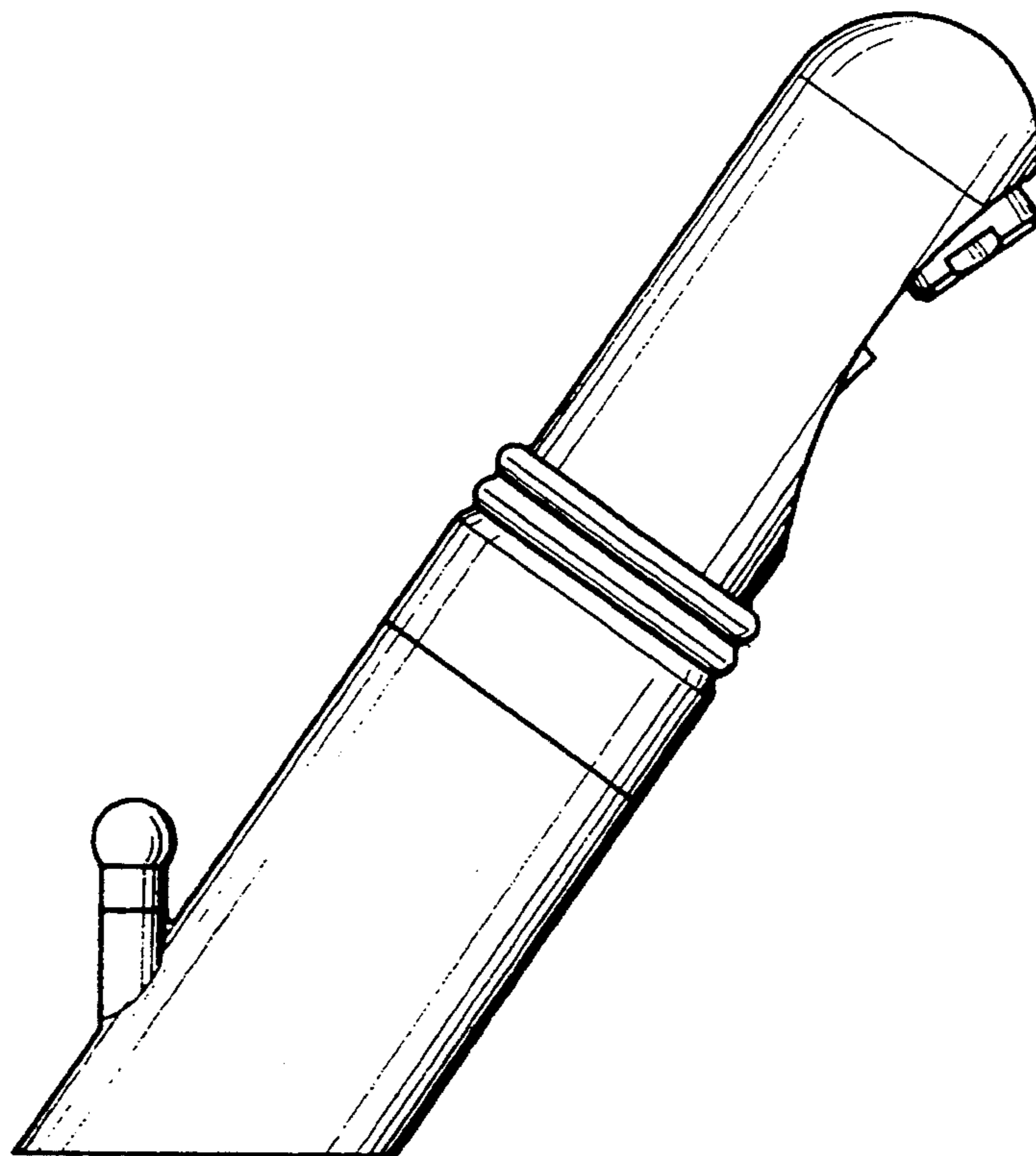

Fig. 4

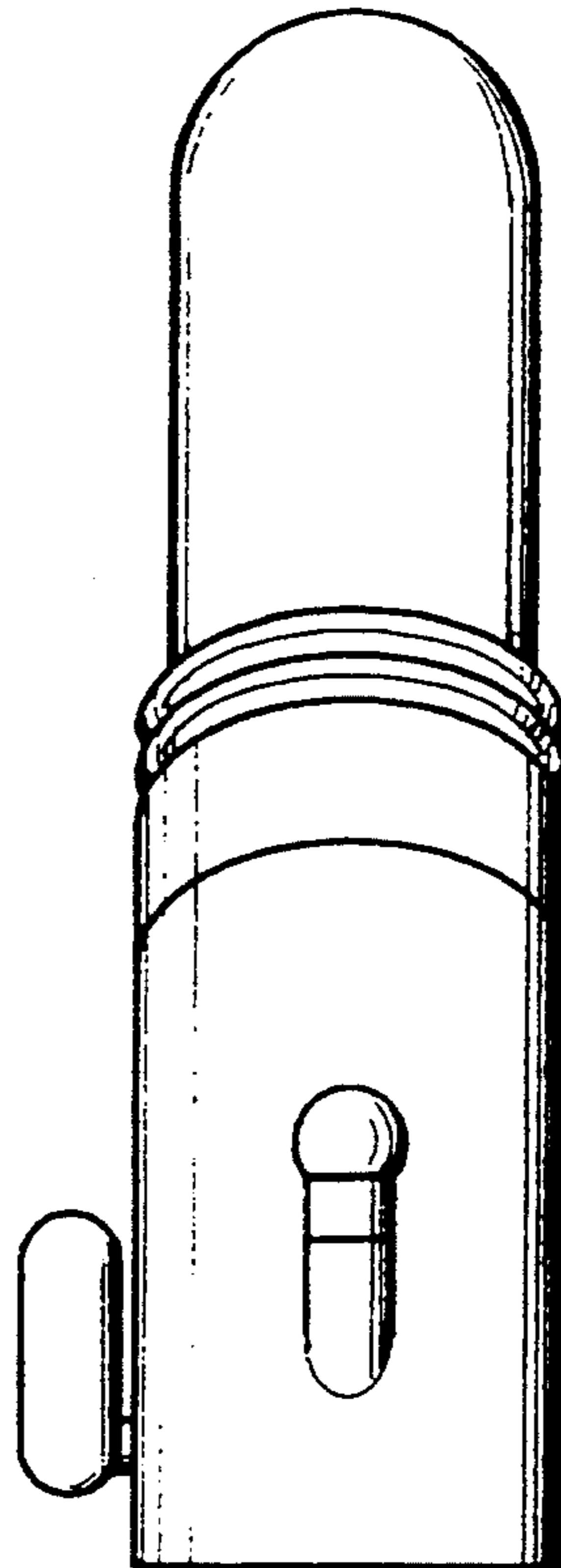

Fig. 5

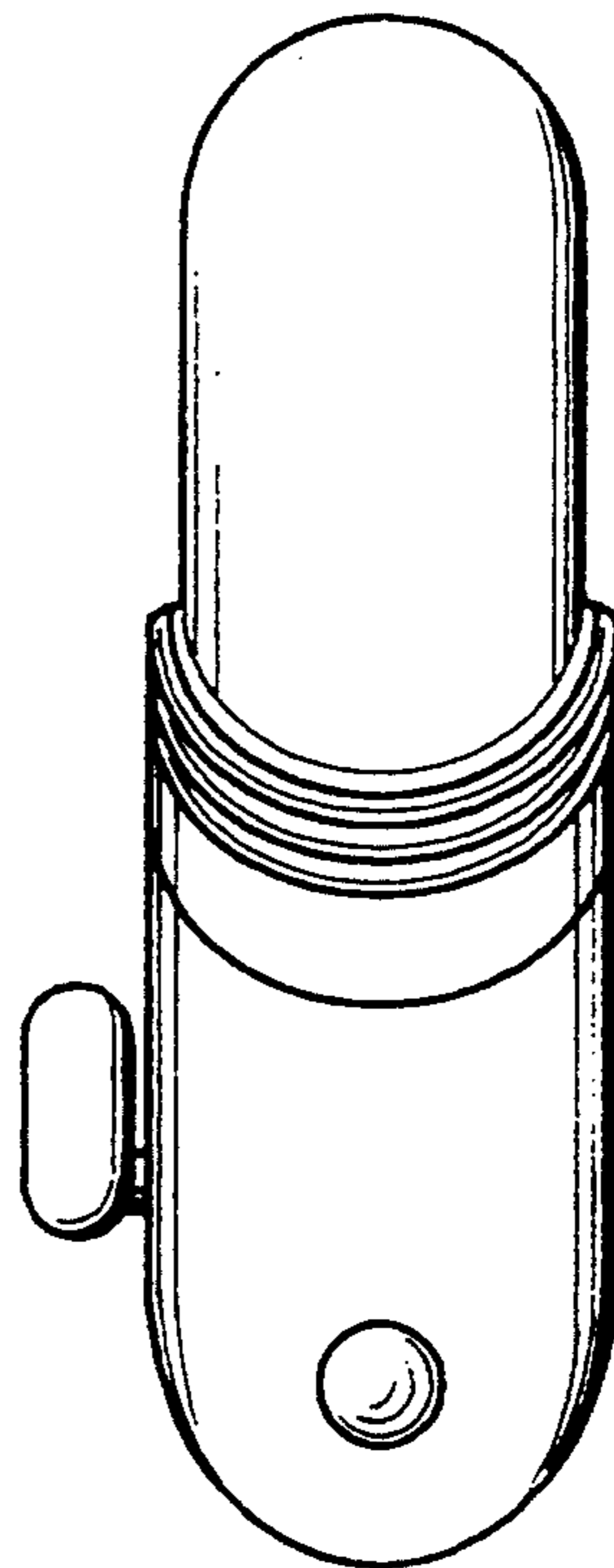

Fig. 6

