



US00D350589S

# United States Patent [19]

Hudson

[11] Patent Number: **Des. 350,589**

[45] Date of Patent: **\*\* Sep. 13, 1994**

[54] **MULTIPLE NOZZLE ON A FLEXIBLE STRAP FOR A GARDEN SPRAYER**

[75] Inventor: **William A. Hudson**, Shorewood, Wis.

[73] Assignee: **H.D. Hudson Manufacturing Company**, Chicago, Ill.

[\*\*] Term: **14 Years**

[21] Appl. No.: **14,566**

[22] Filed: **Oct. 25, 1993**

[52] U.S. Cl. .... **D23/213**

[58] Field of Search ..... 239/200-206, 239/222.11-222.21, 230-233, 273, 275-276, 288, 288.3, 288.5, 443-444, 456, 550-552, 556-558, 391, 392, 394, 395; D23/214-221

[56] **References Cited**

**U.S. PATENT DOCUMENTS**

D. 324,824	3/1992	Hansen	.....	D9/435
3,022,955	3/1962	Riddell	.	
3,091,401	5/1963	Hraby	.....	239/276
3,131,868	5/1964	Coleman	.....	239/391
3,191,809	2/1965	Schultz et al.	.	
3,908,909	9/1975	Kaatz	.....	239/276
4,135,669	1/1979	Bridges et al.	.....	239/391
4,382,530	3/1981	Calisto	.	

*Primary Examiner*—Wallace R. Burke  
*Assistant Examiner*—Robin V. Taylor  
*Attorney, Agent, or Firm*—Kane, Dalsimer, Sullivan, Kurucz, Levy, Eisele & Richard

[57] **CLAIM**

The original design for multiple nozzle on a flexible strap for a garden sprayer, as shown and described.

**DESCRIPTION**

FIG. 1 is a top plan view of a multiple nozzle on a flexible strap for a garden sprayer showing my design; FIG. 2 is a side elevational view thereof; FIG. 3 is a bottom plan view thereof; FIG. 4 is a left end view thereof; FIG. 5 is a right end view thereof; FIG. 6 is a perspective view thereof; the broken line showing is for illustrative purposes only and forms no part of the claimed design; FIG. 7 is a top plan view of a multiple nozzle on a flexible strap for a garden sprayer showing another embodiment of my design; FIG. 8 is a side elevational view thereof; FIG. 9 is a bottom plan view thereof; FIG. 10 is a left end view thereof; FIG. 11 is a right end view thereof; FIG. 12 is perspective view thereof; the broken line showing is for illustrative purposes only and forms no part of the claimed design.

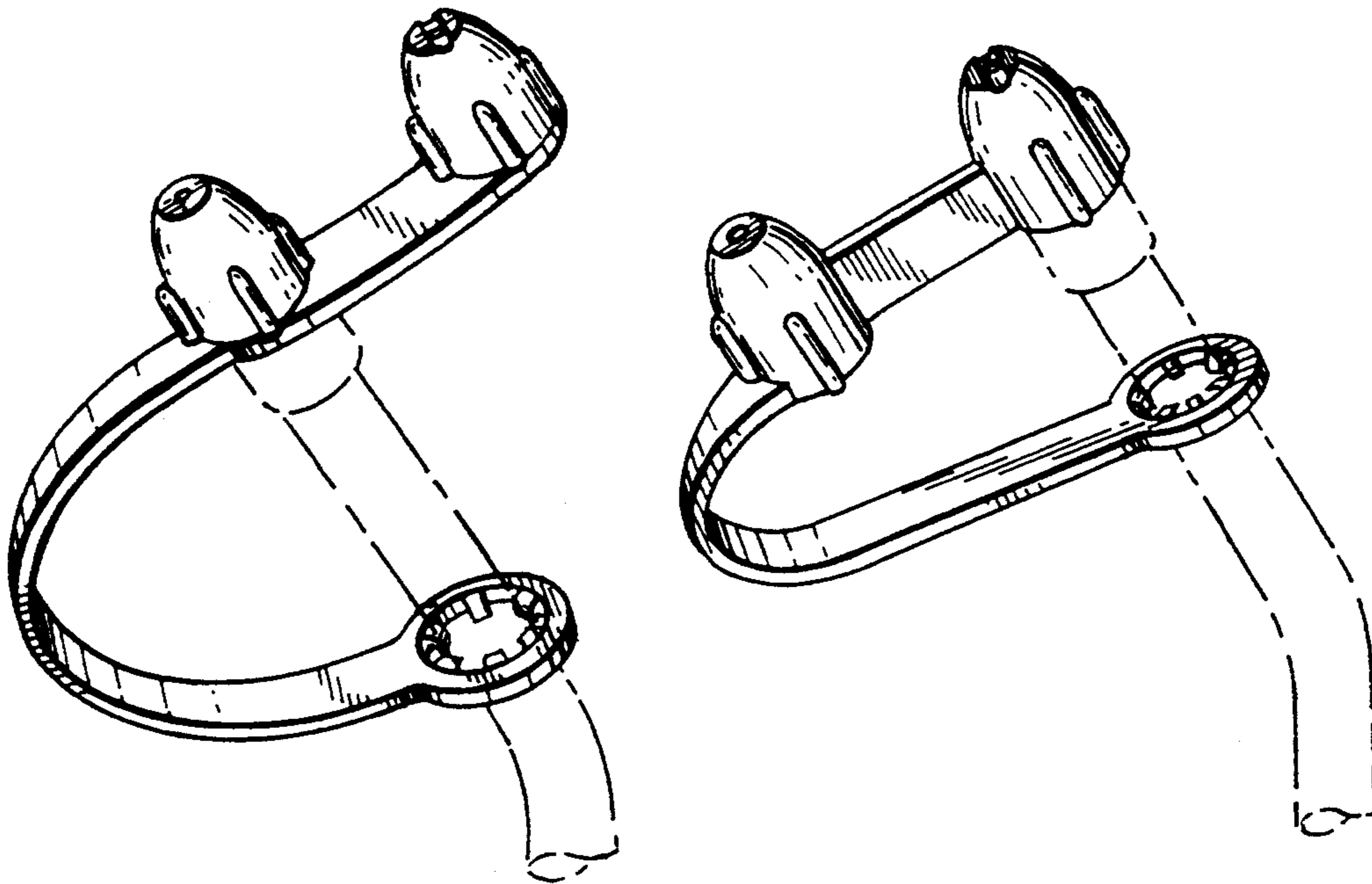

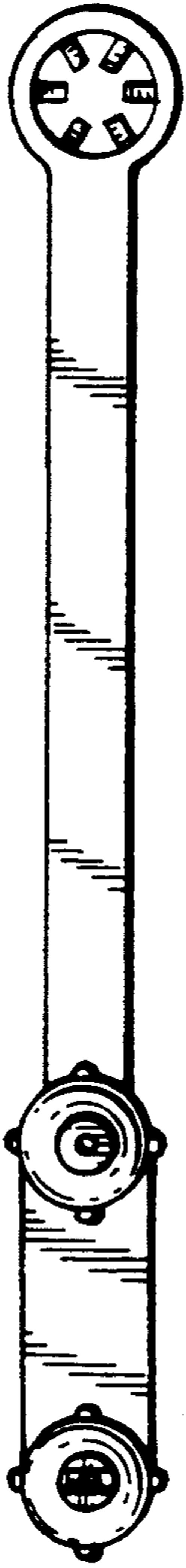

FIG. 1

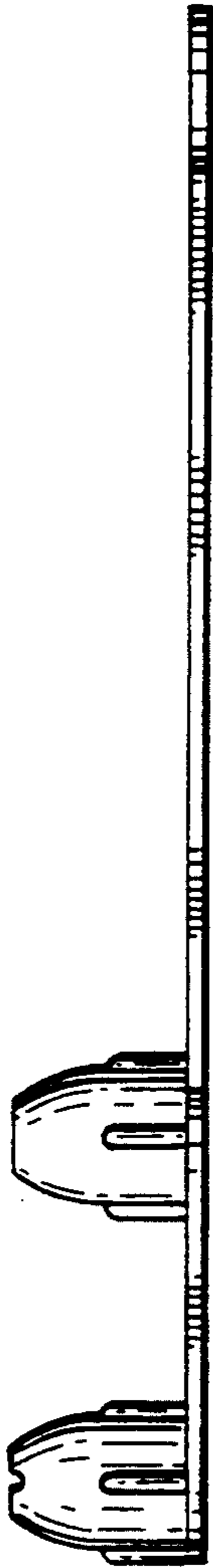

FIG. 2



FIG. 4  
FIG. 5

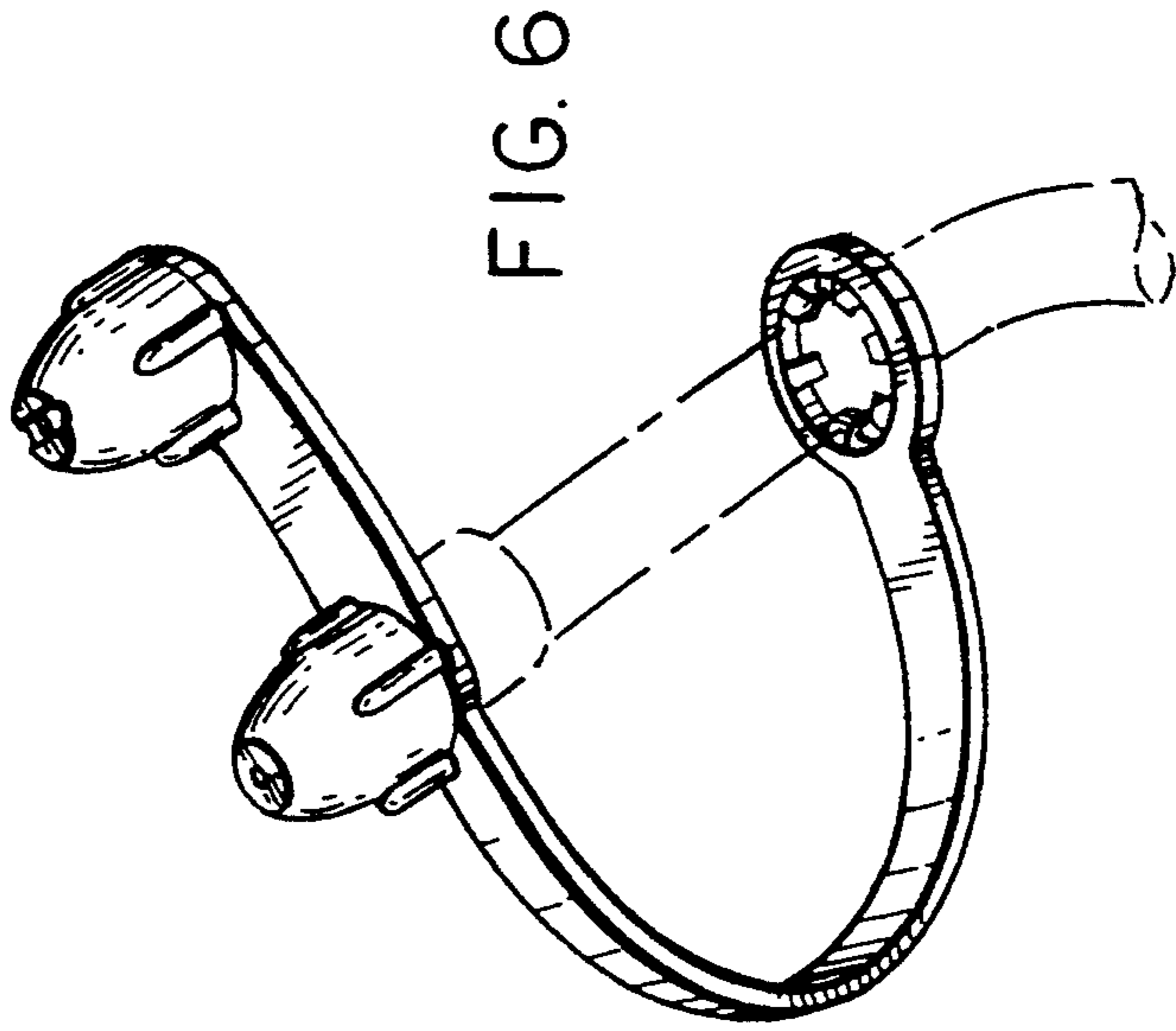

FIG. 6

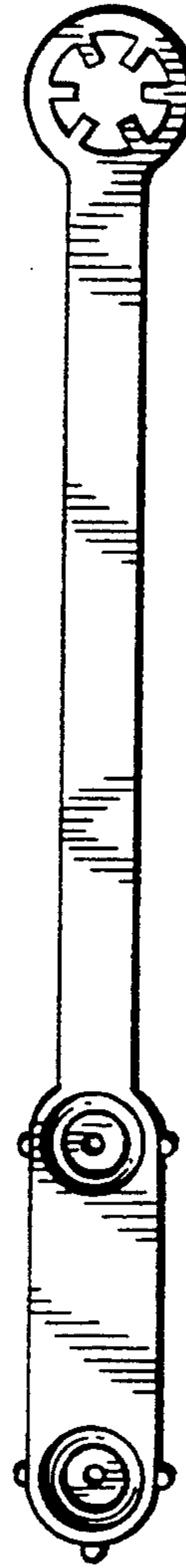

FIG. 3

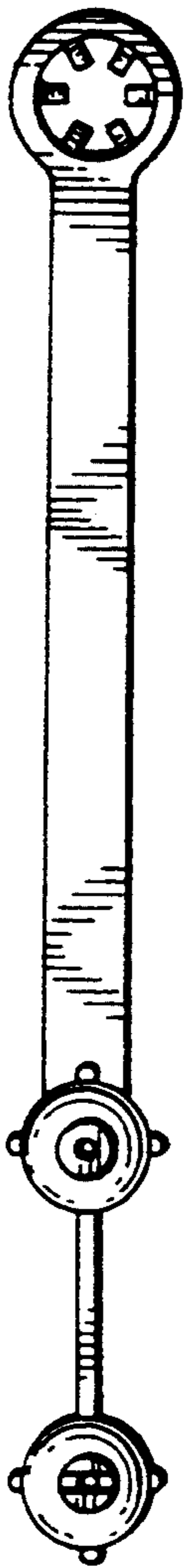

FIG. 7



FIG. 8

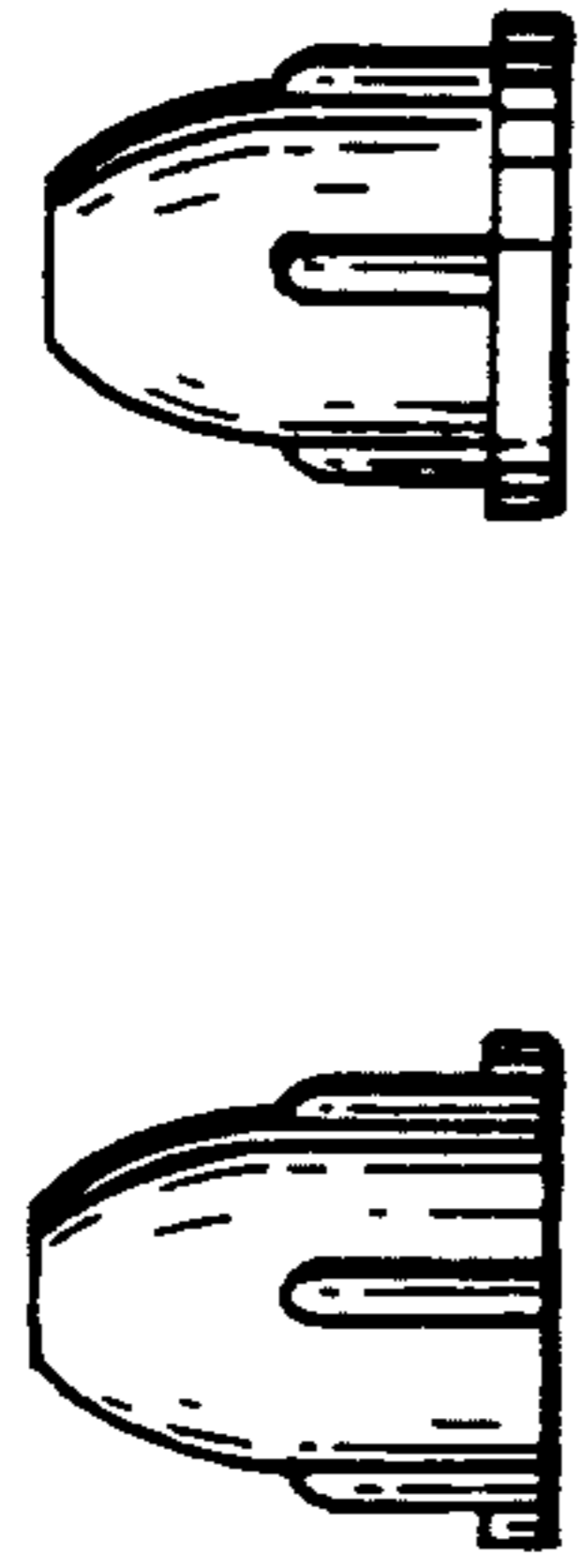

FIG. 10

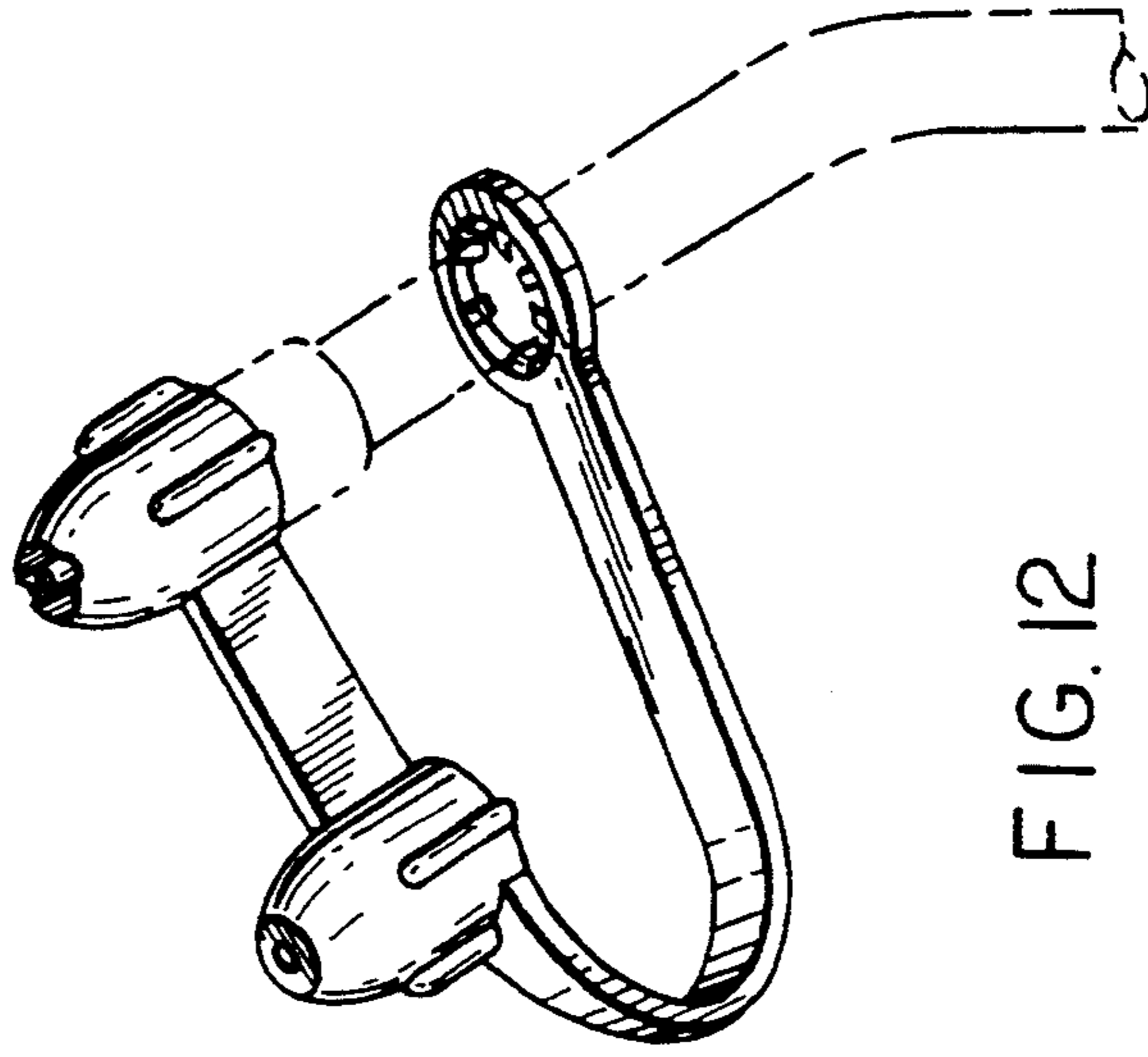

FIG. 12