



US00D350522S

United States Patent [19]

[11] Patent Number: **Des. 350,522**

Myles et al.

[45] Date of Patent: **** Sep. 13, 1994**

[54] **VEHICLE MIRROR BASE**

[75] Inventors: **Dennis Myles, W. Bloomfield; John R. Starr, Woodhaven; Trevor M. Creed, W. Bloomfield, all of Mich.**

[73] Assignee: **Chrysler Coproration, Highland Park, Mich.**

[**] Term: **14 Years**

[21] Appl. No.: **377**

[22] Filed: **Oct. 13, 1992**

[52] U.S. Cl. **D12/187**

[58] Field of Search 359/838, 842, 843, 844, 359/849, 850, 854, 860, 862-866, 868, 876, 871-874, 881; D12/187

[56] **References Cited**

U.S. PATENT DOCUMENTS

- D. 249,340 9/1978 Braid D12/187
- D. 271,480 11/1983 Vitaloni D12/187

Primary Examiner—James M. Gandy
Attorney, Agent, or Firm—Mark P. Calcaterra

[57] **CLAIM**

The ornamental design for a vehicle mirror base, as shown and described.

DESCRIPTION

FIG. 1 is a rear perspective view of a vehicle mirror base constructed in accordance to the teachings of the present invention it being understood that the broken line showing of environmental structure is for illustrative purposes only and forms no part of the claimed design;

FIG. 2 is a rear view of the vehicle mirror base shown in FIG. 1;

FIG. 3 is a front view of the vehicle mirror base shown in FIG. 1;

FIG. 4 is a top view of the vehicle mirror base shown in FIG. 1;

FIG. 5 is a bottom view of the vehicle mirror base shown in FIG. 1;

FIG. 6 is a left end view of the vehicle mirror base shown in FIG. 1; and,

FIG. 7 is a right end view of the vehicle mirror base shown in FIG. 1.

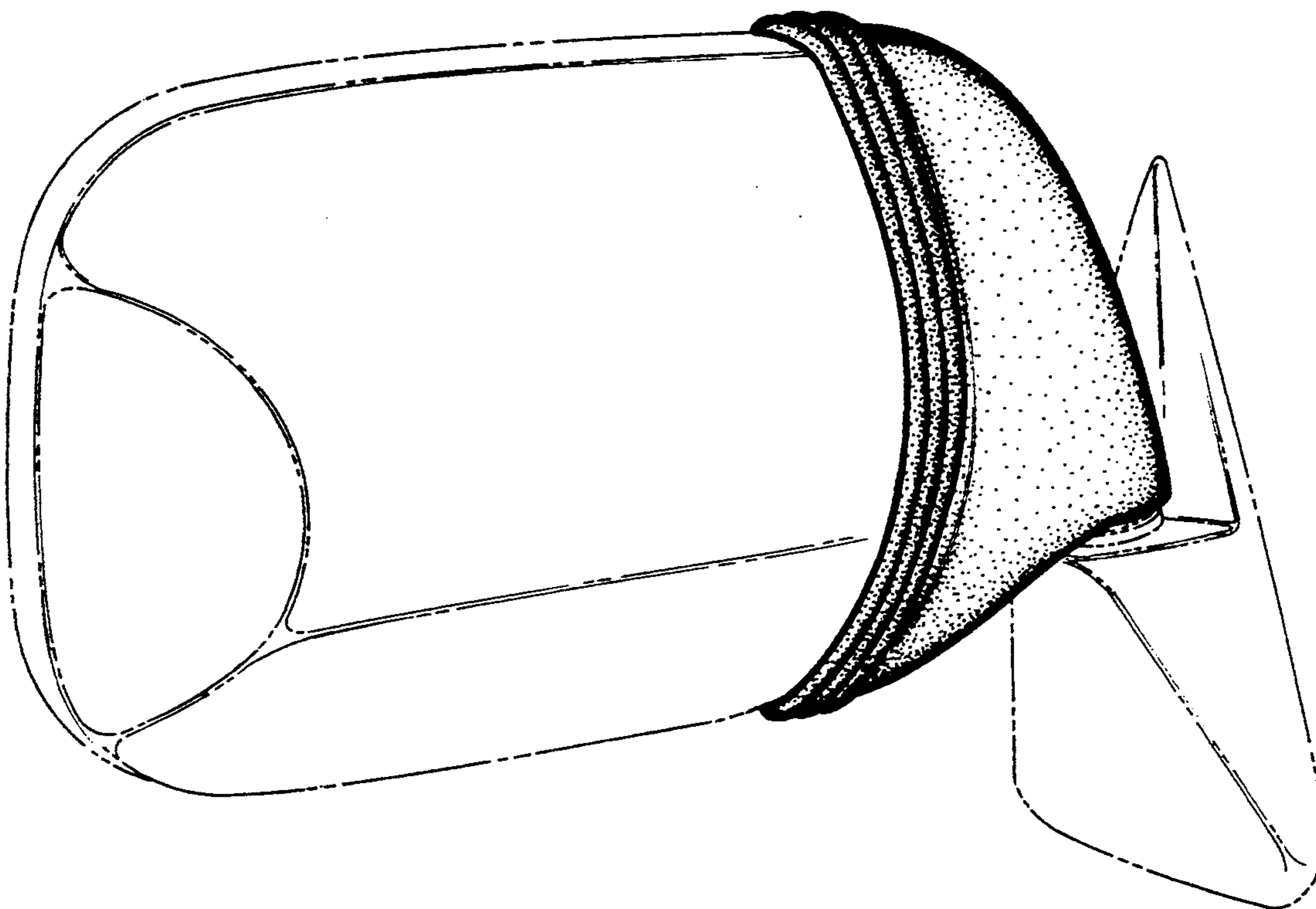

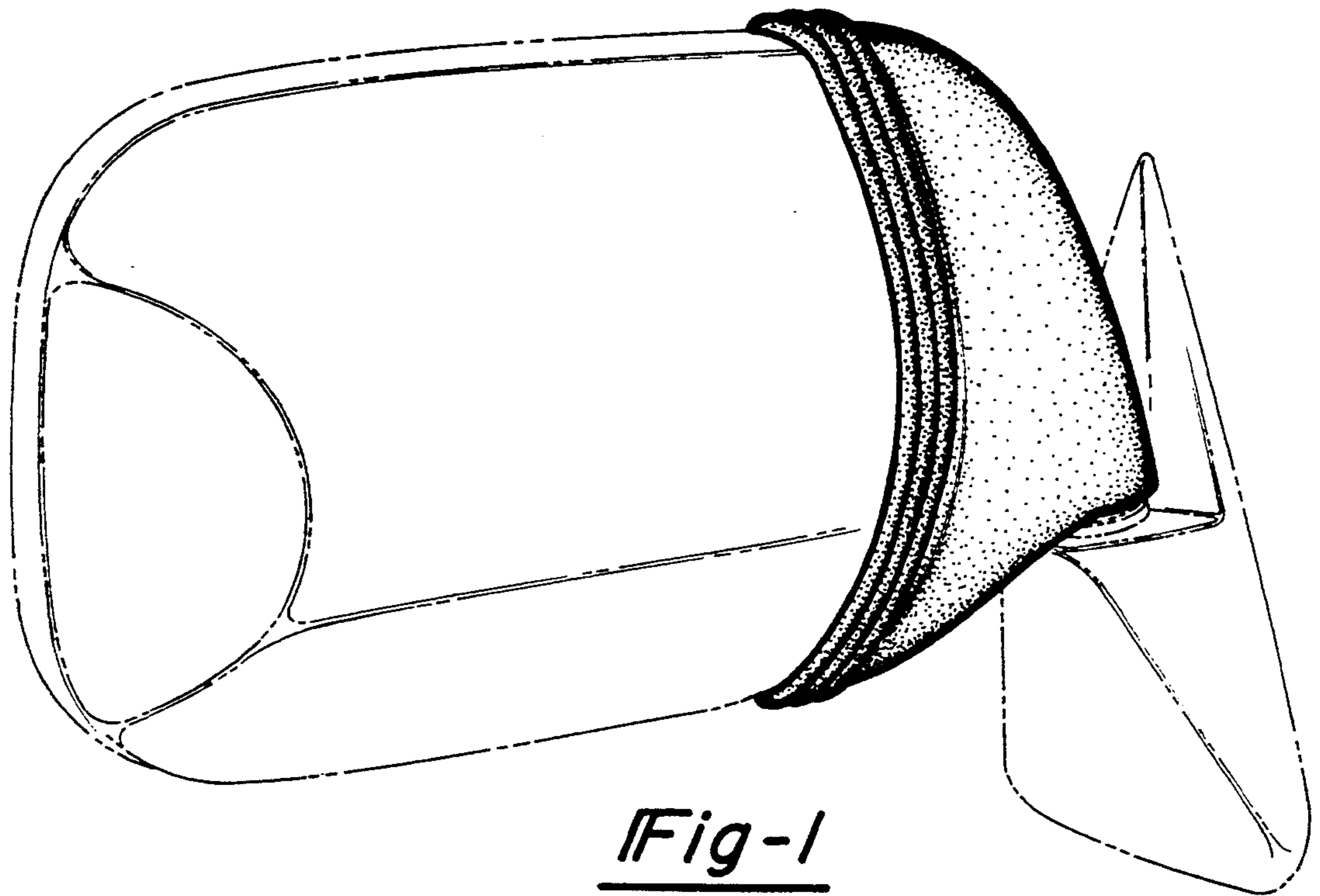

Fig-1

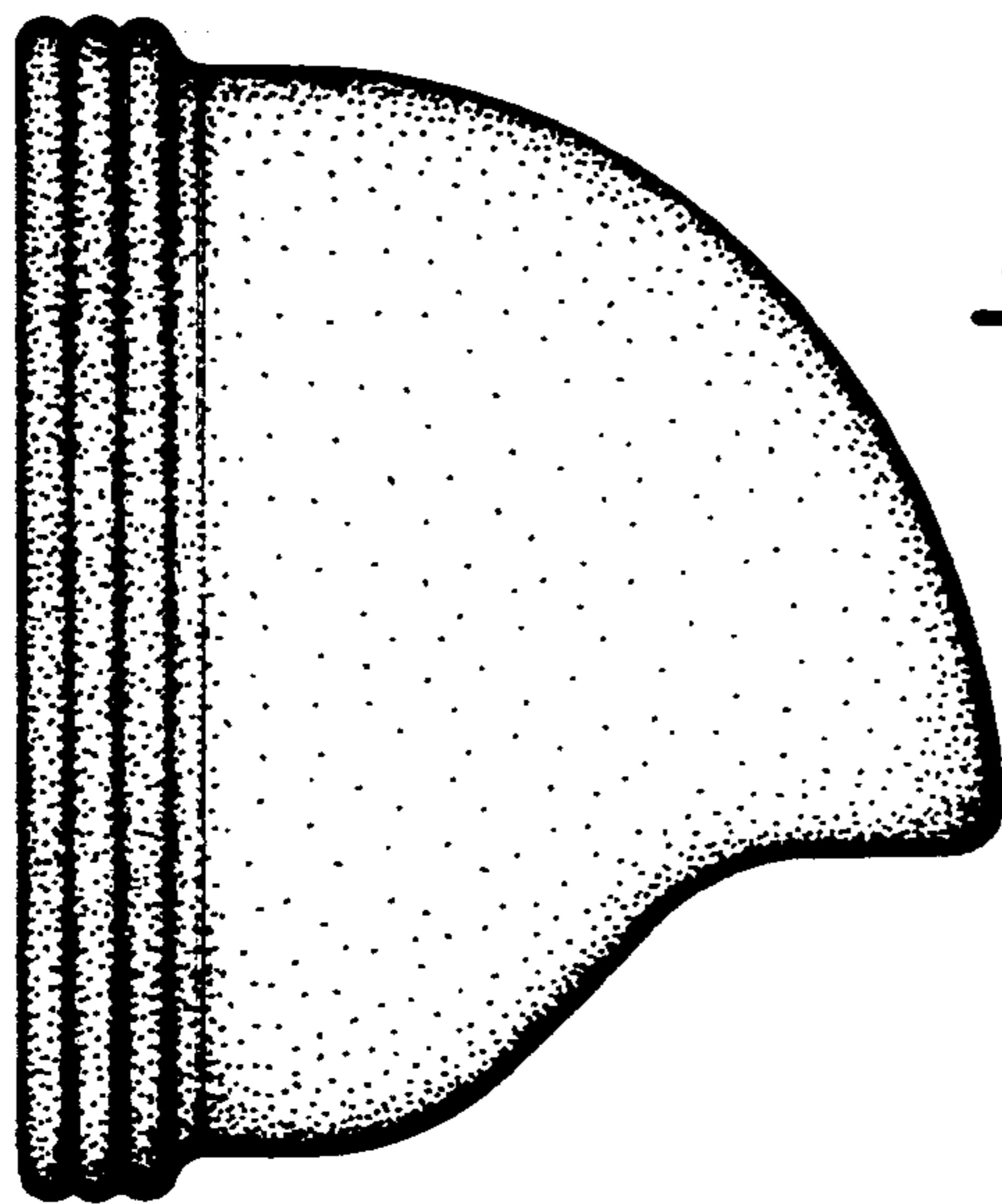

Fig-2

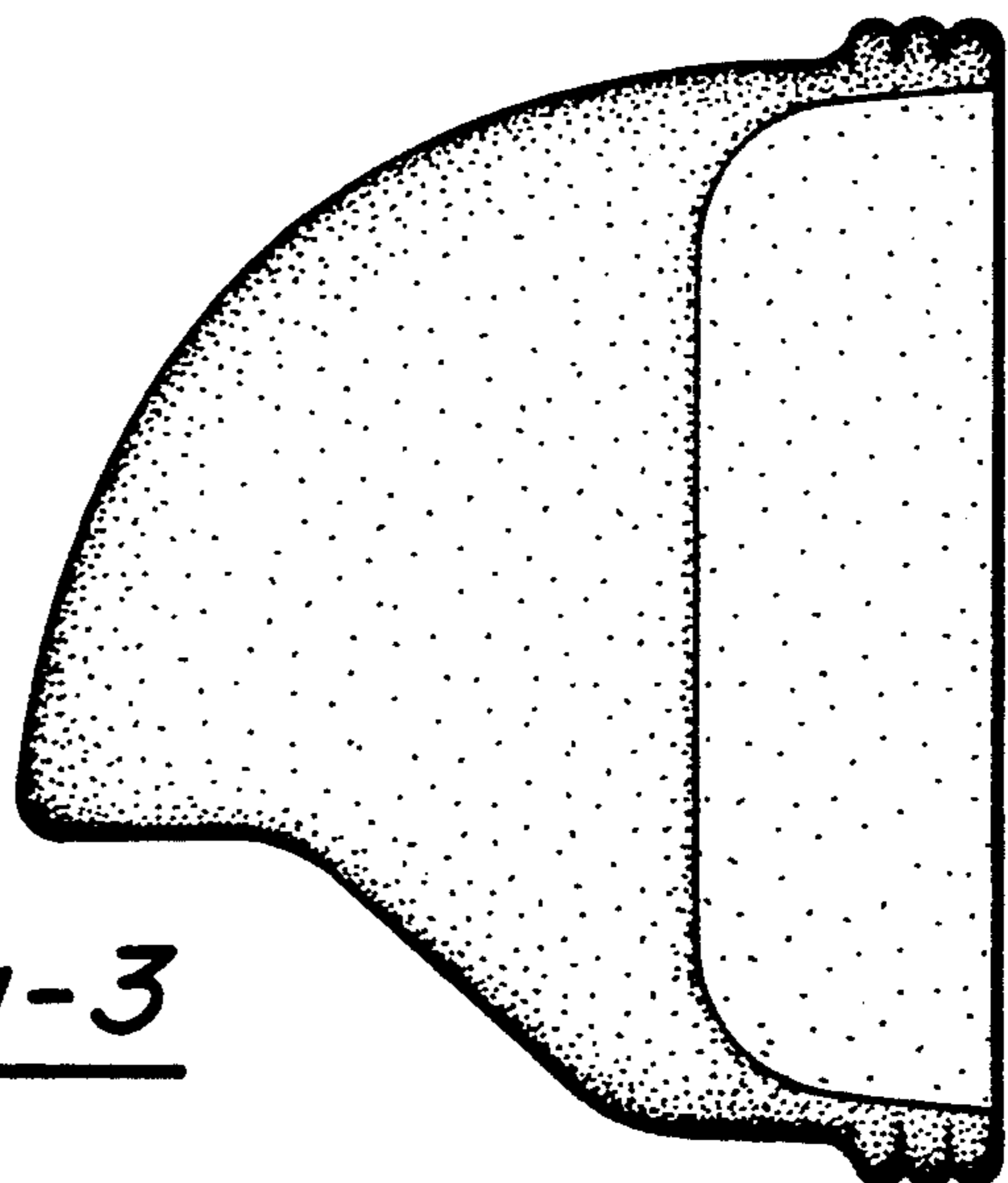

Fig-3

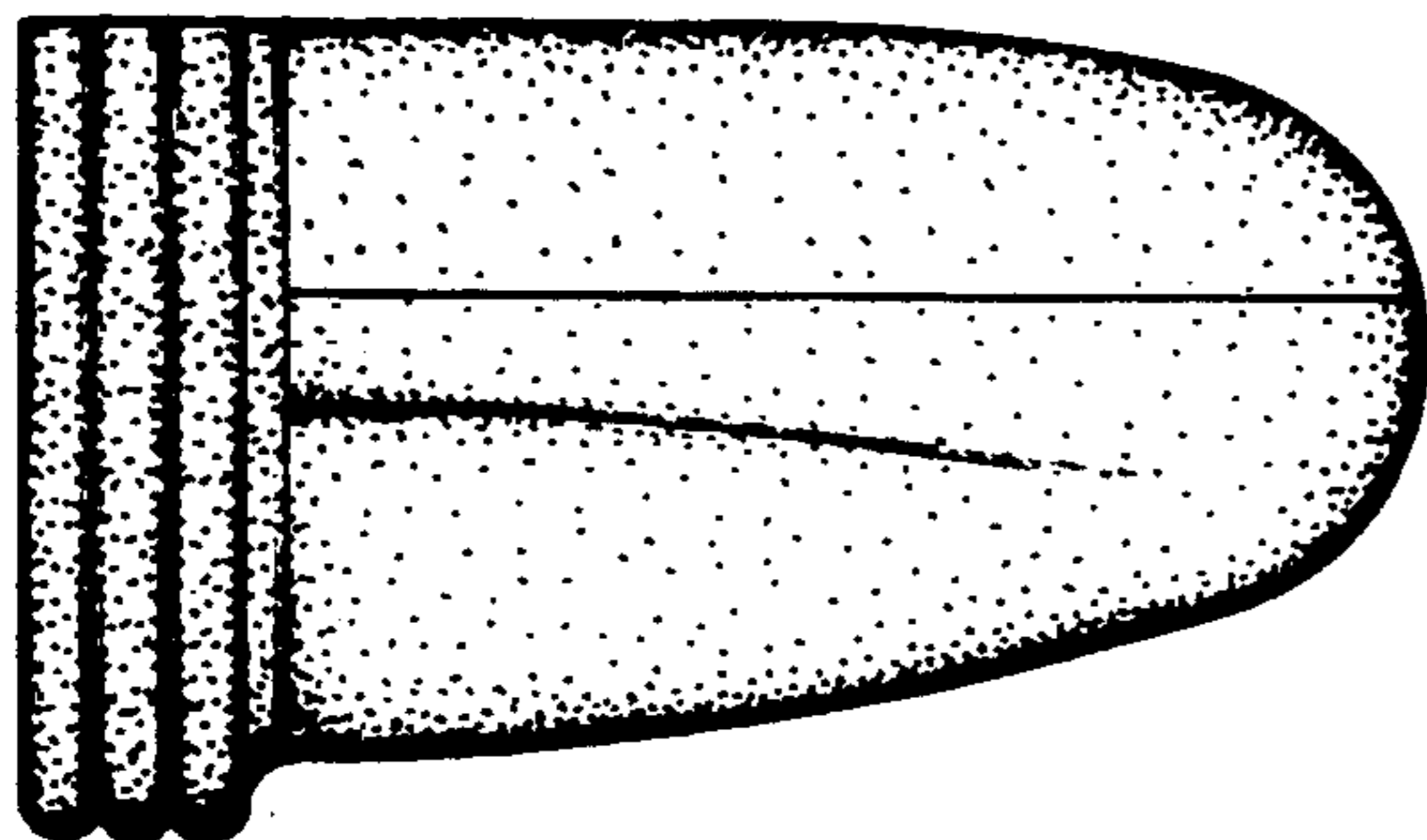

Fig-4

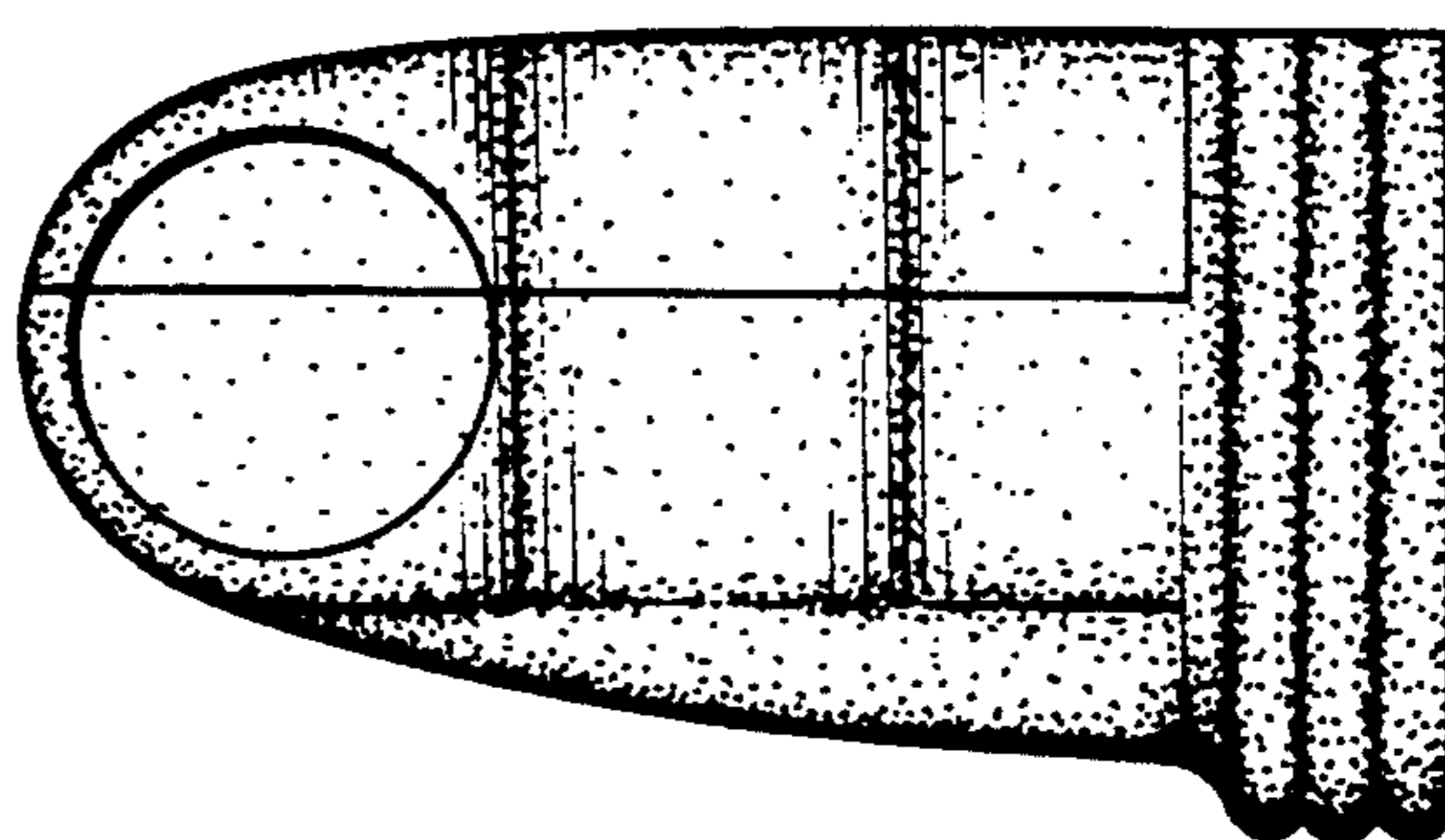

Fig-5

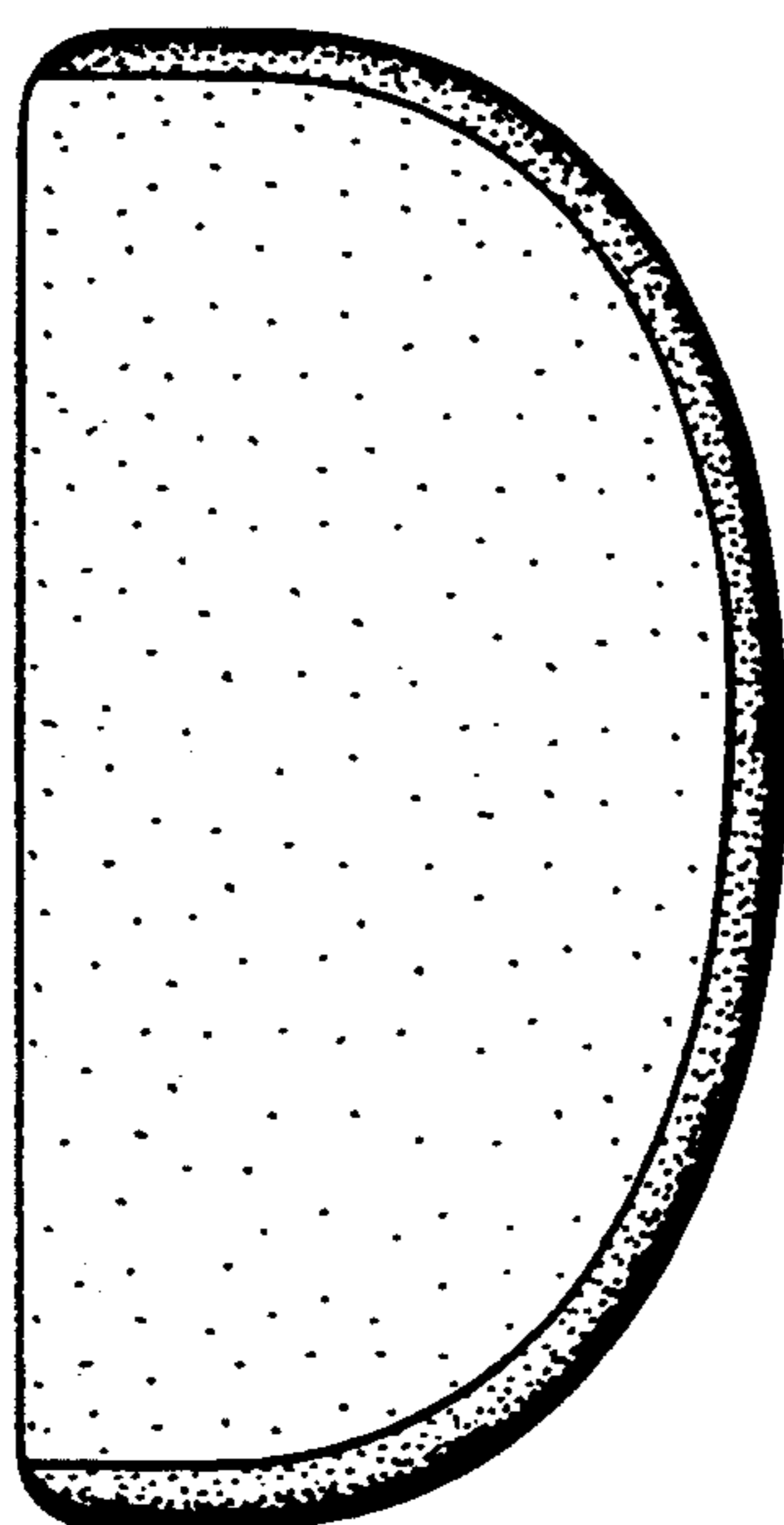

Fig-6

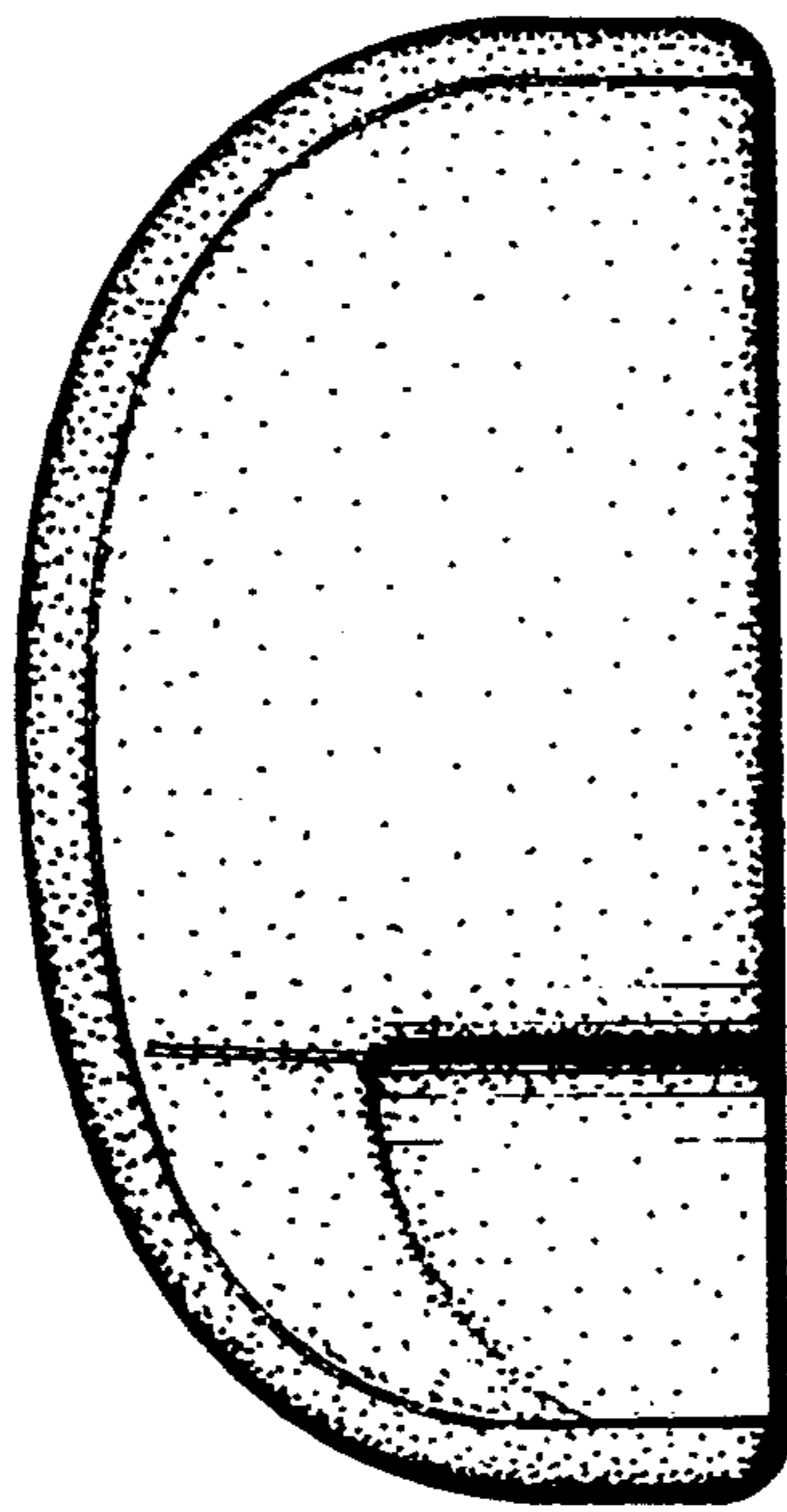

Fig-7