



US00D350470S

United States Patent [19]

[11] Patent Number: **Des. 350,470**

Majors et al.

[45] Date of Patent: **** Sep. 13, 1994**

- [54] **COMBINED HANDLE AND HEAD FOR A HAMMER**
- [75] Inventors: **Ronald O. Majors, Salem; Joseph R. Hoepfl, Greenfield, both of Wis.**
- [73] Assignee: **Snap-On Incorporated, Kenosha, Wis.**
- [**] Term: **14 Years**
- [21] Appl. No.: **4,673**
- [22] Filed: **Feb. 11, 1993**
- [52] U.S. Cl. **D8/80; D8/77**
- [58] Field of Search **D8/75, 76, 77, 78, 79, D8/80; 81/19, 20, 21, 22, 25, 26, 27**

[56] References Cited

U.S. PATENT DOCUMENTS

D. 179,018	10/1956	Lowe	D8/77
D. 182,132	2/1958	MacMinn	D8/77
D. 182,133	2/1958	MacMinn	D8/77
D. 182,134	2/1958	MacMinn	D8/77
D. 285,284	8/1986	Blomqvist	D8/77
D. 288,897	3/1987	Kalberer	D8/77
D. 302,932	8/1989	Chapin et al.	D8/77
2,808,861	10/1957	Hughes	81/19
3,088,506	5/1963	Bianchini	81/19
3,844,321	10/1974	Cook	81/26
5,012,702	5/1991	Taylor	81/26

Primary Examiner—Bernard Ansher
Assistant Examiner—Philip Hyder
Attorney, Agent, or Firm—Emrich & Dithmar

[57] CLAIM

The ornamental design for a combined handle and head for a hammer, as shown and described.

DESCRIPTION

FIG. 1 is a front elevational view of a combined handle and head for a hammer showing my new design, the rear view being identical;

FIG. 2 is a side view of one side thereof, the other side being identical;
 FIG. 3 is a top plan view thereof;
 FIG. 4 is a bottom plan view thereof;
 FIG. 5 is an enlarged sectional view taken along the line 5—5 of FIG. 1;
 FIG. 6 is an enlarged sectional view taken along the line 6—6 of FIG. 1;
 FIG. 7 is an enlarged view taken along the line 7—7 of FIG. 1;
 FIG. 8 is an enlarged sectional view taken along the line 8—8 of FIG. 1;
 FIG. 9 is an enlarged sectional view taken along the line 9—9 of FIG. 1;
 FIG. 10 is an enlarged sectional view taken along the line 10—10 of FIG. 1;
 FIG. 11 is an enlarged sectional view taken along the line 11—11 of FIG. 1;
 FIG. 12 is a front elevational view of a second embodiment thereof, the rear view being a mirror image;
 FIG. 13 is a top plan view thereof;
 FIG. 14 is a bottom plan view thereof;
 FIG. 15 is a left side elevational view thereof;
 FIG. 16 is a right side elevational view thereof;
 FIG. 17 is an enlarged sectional view taken along the line 17—17 of FIG. 12;
 FIG. 18 is an enlarged sectional view taken along the line 18—18 of FIG. 12;
 FIG. 19 is an enlarged sectional view taken along the line 19—19 of FIG. 12;
 FIG. 20 is an enlarged sectional view taken along the line 20—20 of FIG. 12;
 FIG. 21 is an enlarged sectional view taken along the line 21—21 of FIG. 12;
 FIG. 22 is an enlarged sectional view taken along the line 22—22 of FIG. 12;
 FIG. 23 is an enlarged sectional view taken along the line 23—23 of FIG. 12; and,
 FIG. 24 is an enlarged sectional view taken along the line 24—24 of FIG. 12.
 The broken line showing of the striking tips is for illustrative purposes only and forms no part of the claimed design.

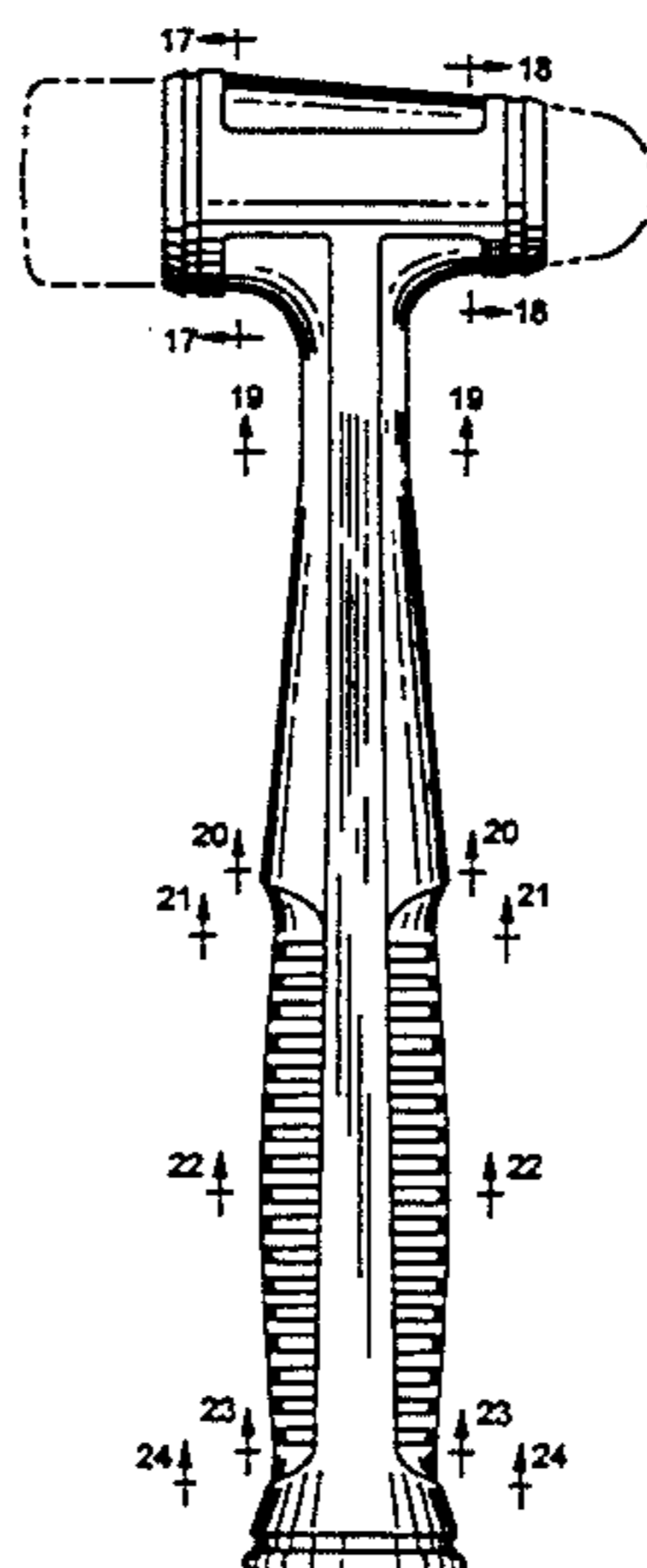

FIG. 1

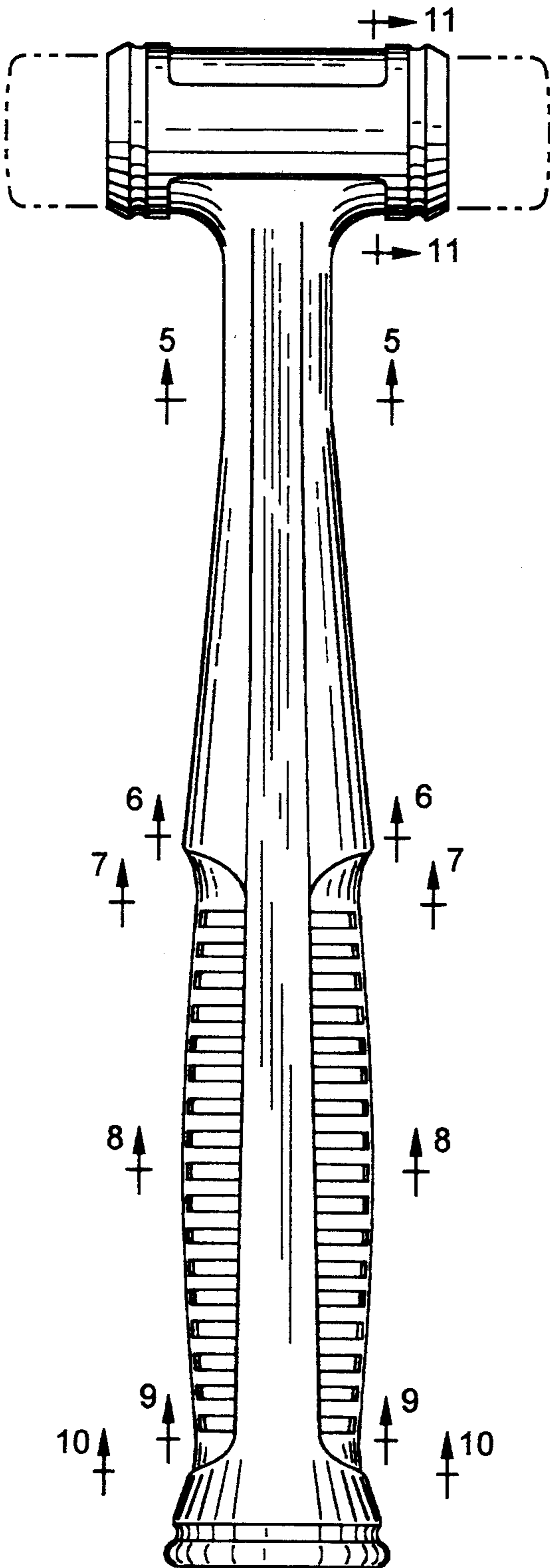

FIG. 3

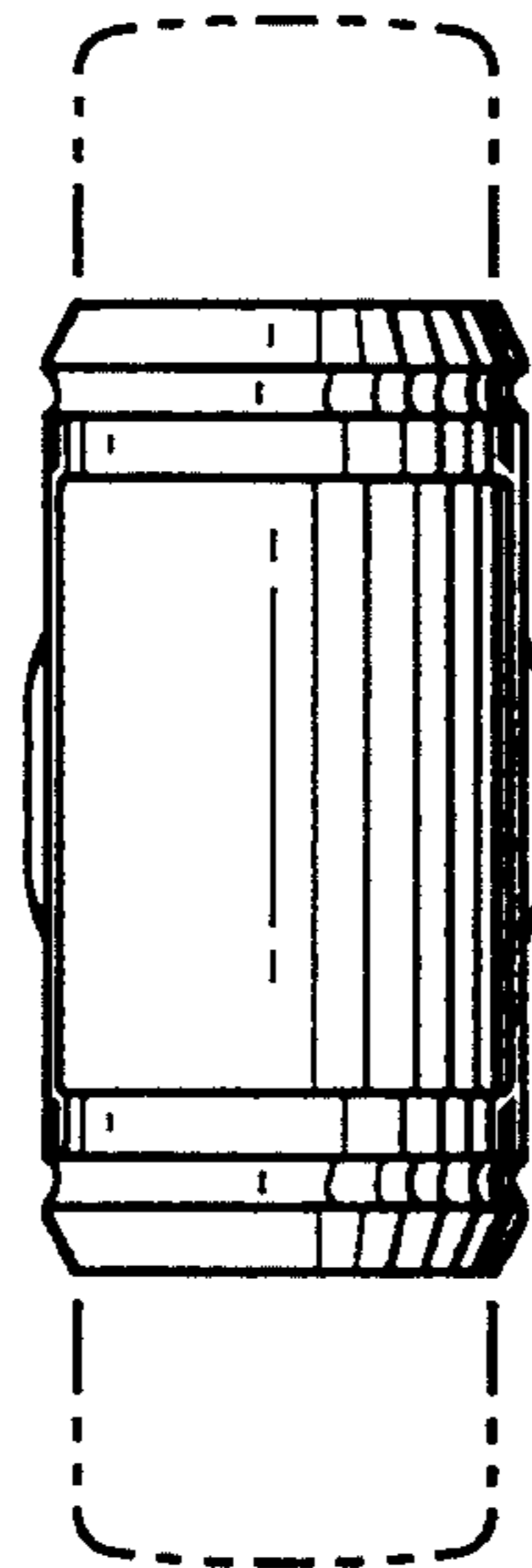

FIG. 2

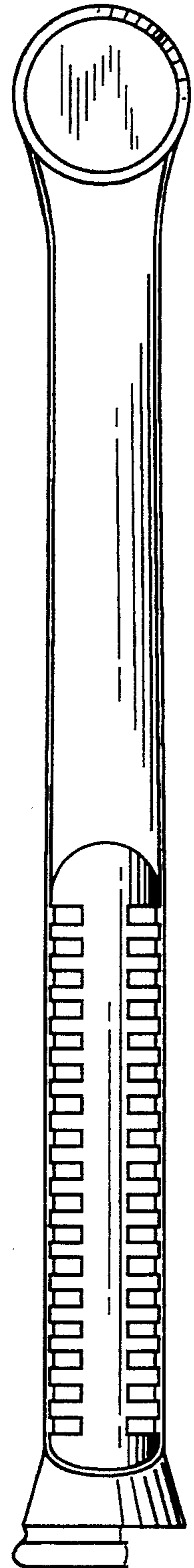

FIG. 4

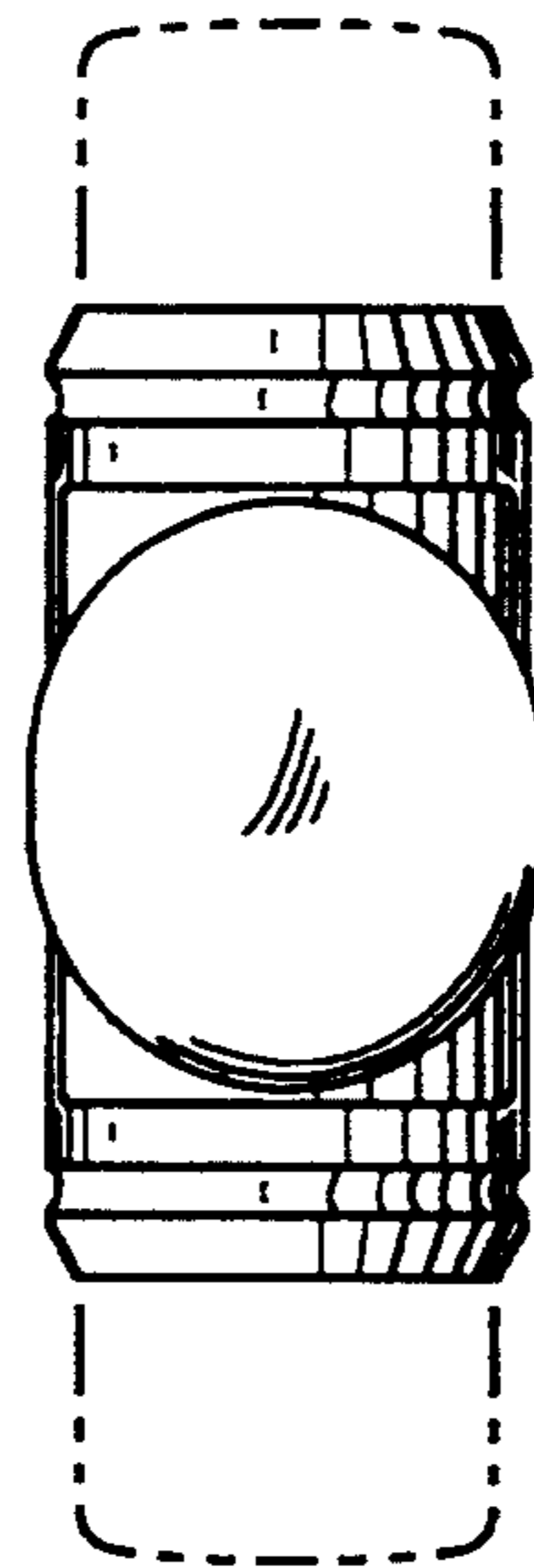

FIG. 5

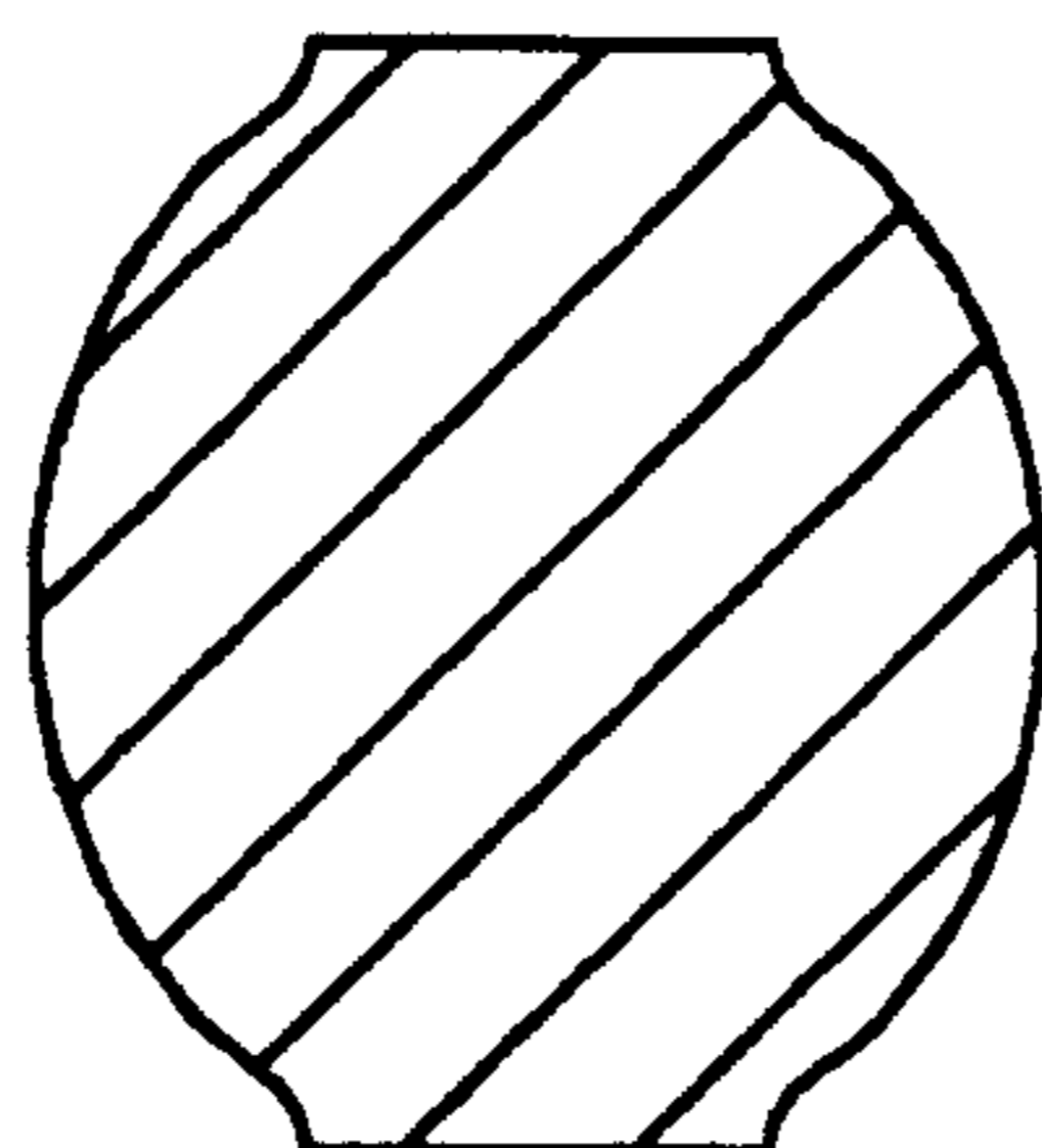

FIG. 6

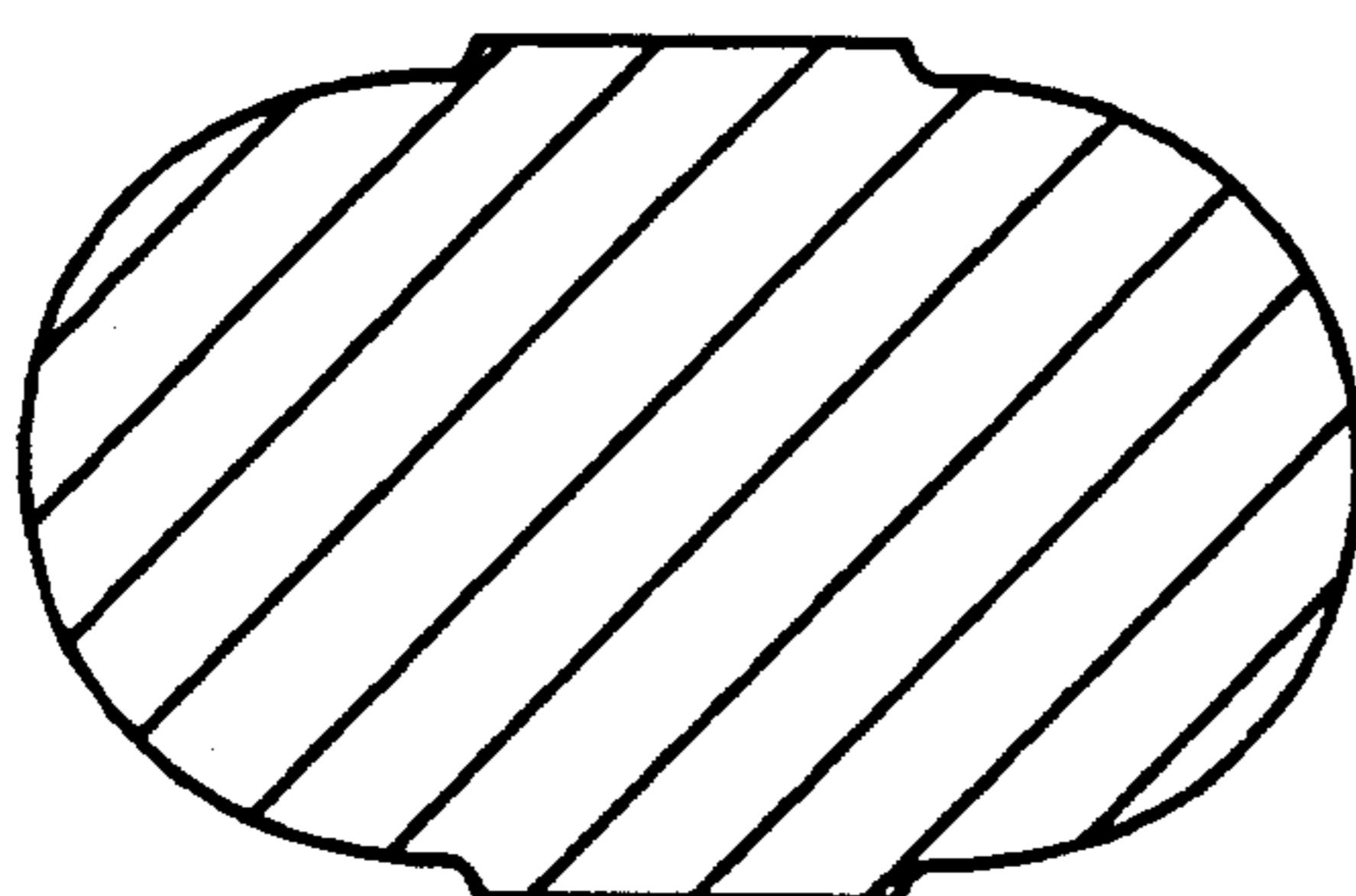

FIG. 7

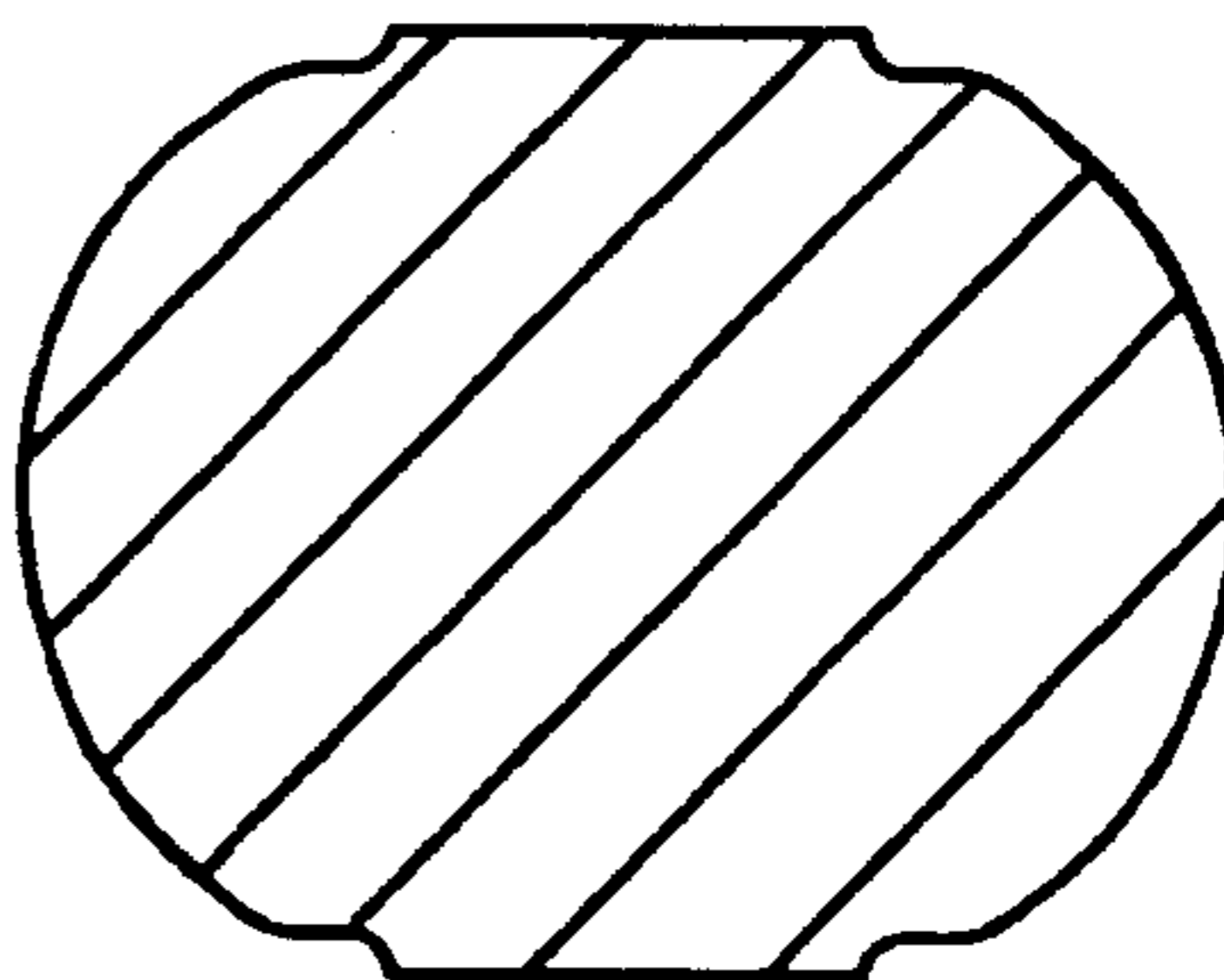

FIG. 8

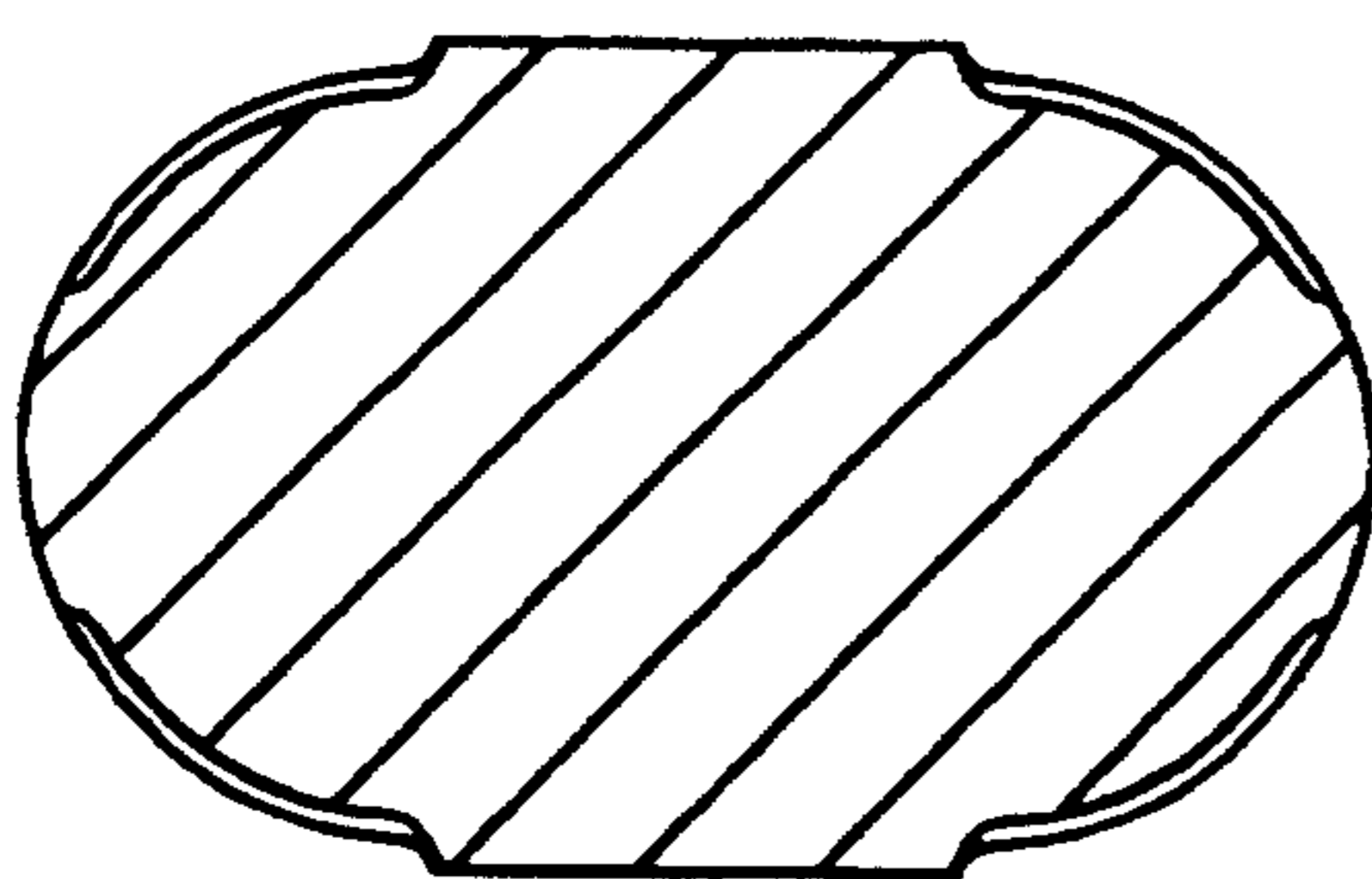

FIG. 9

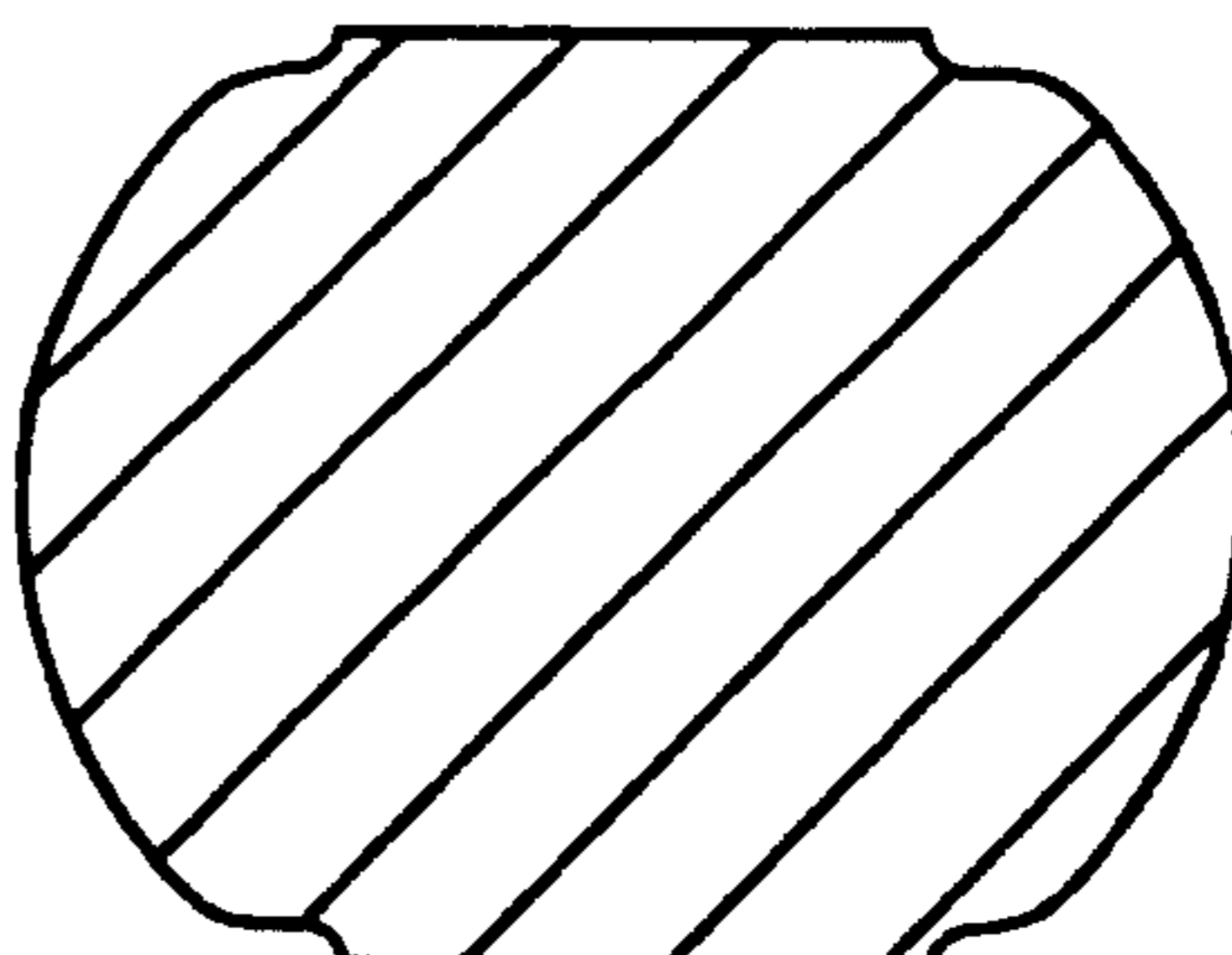

FIG. 10

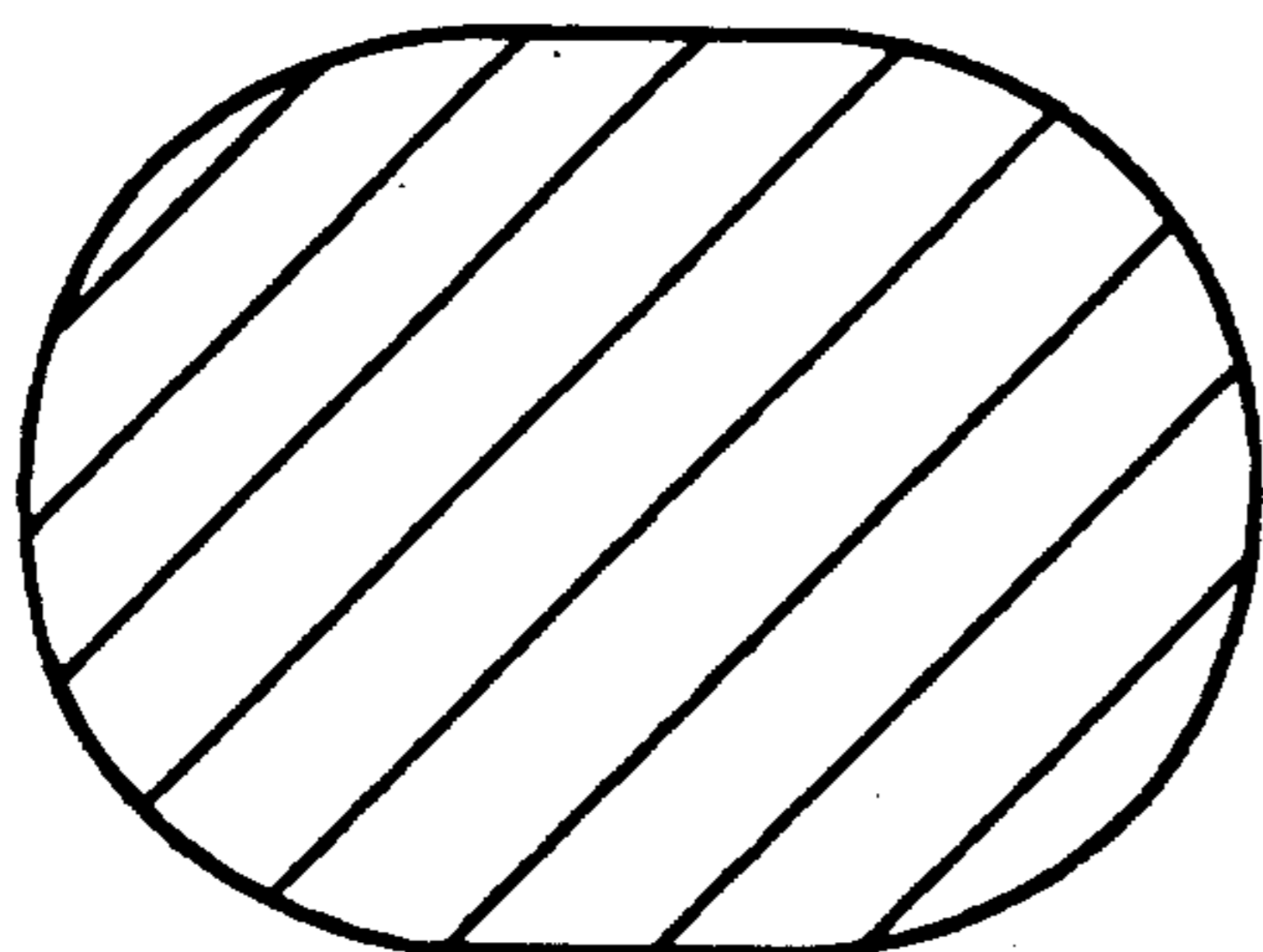

FIG. 11

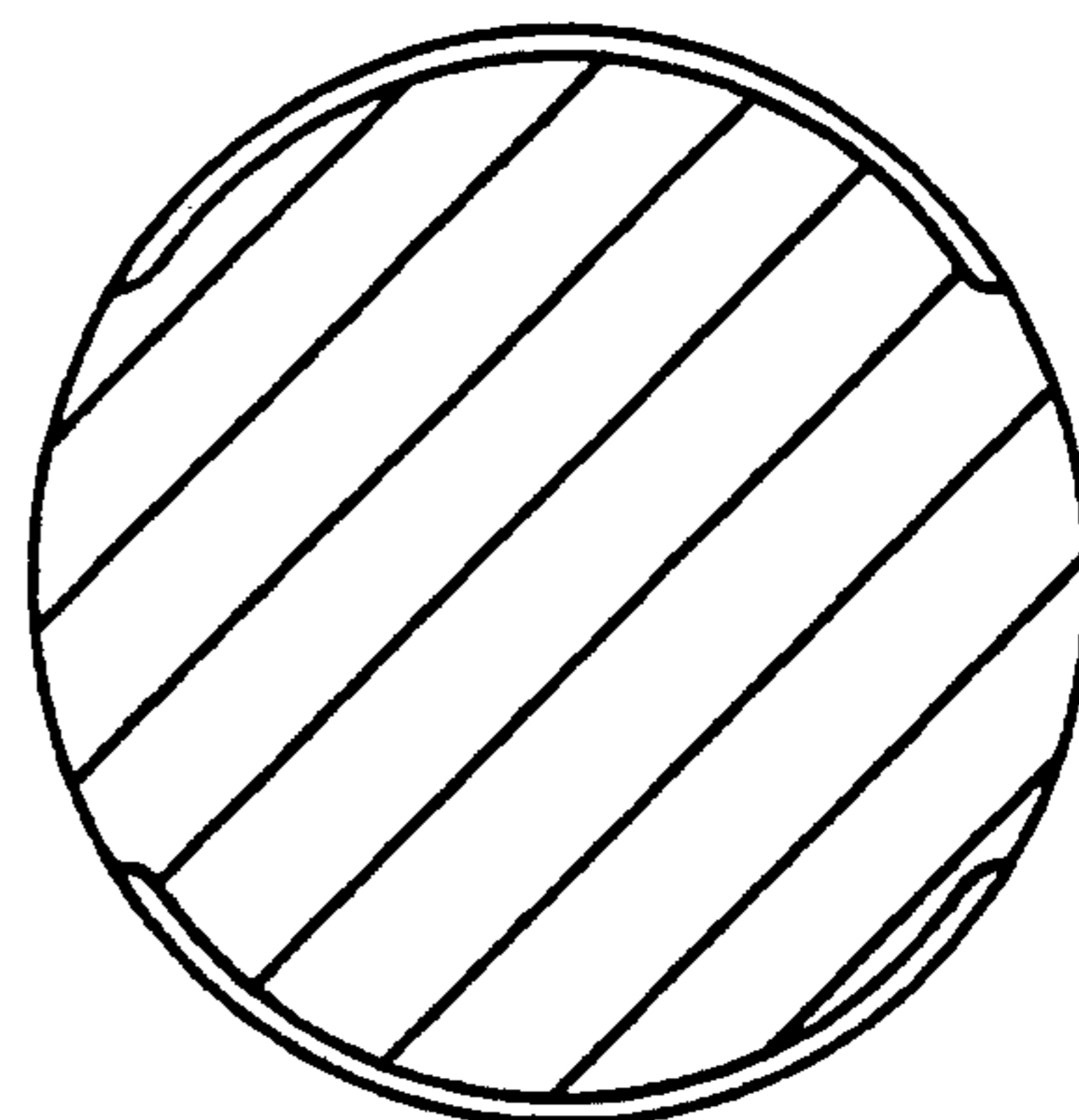

FIG. 12

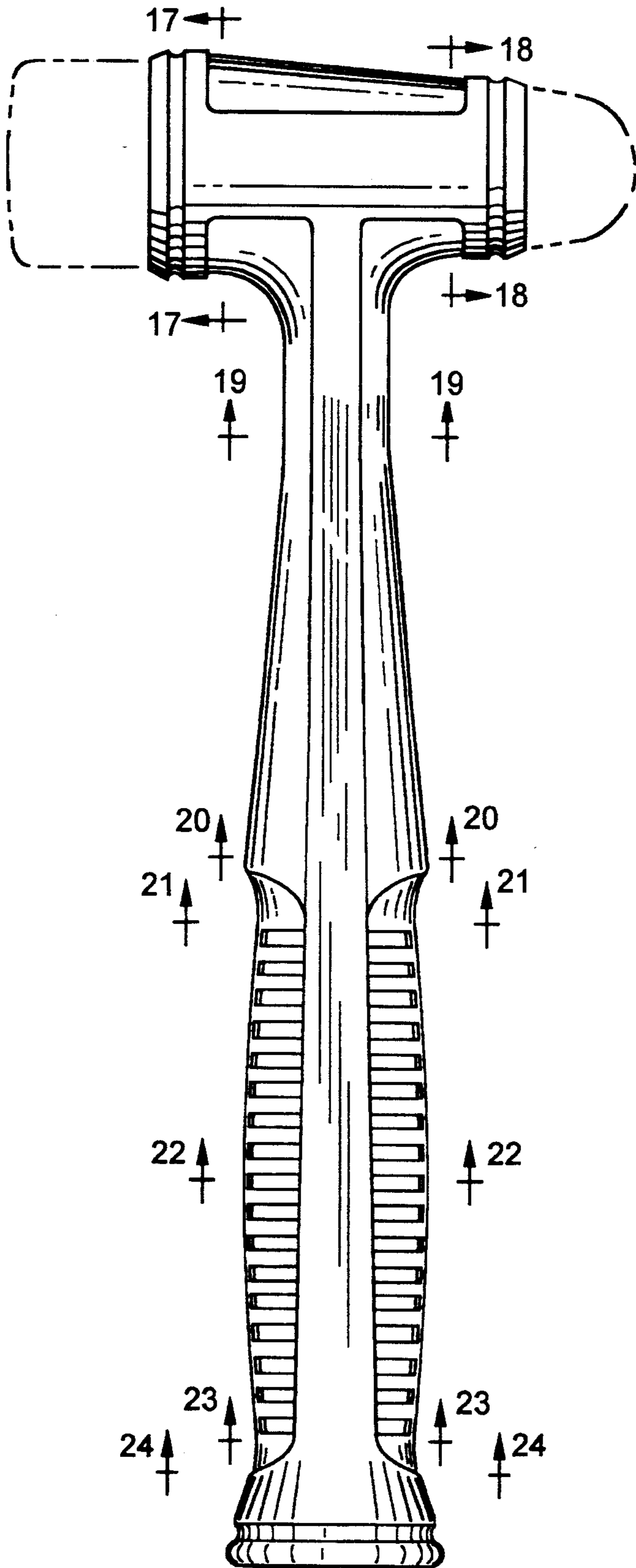

FIG. 13

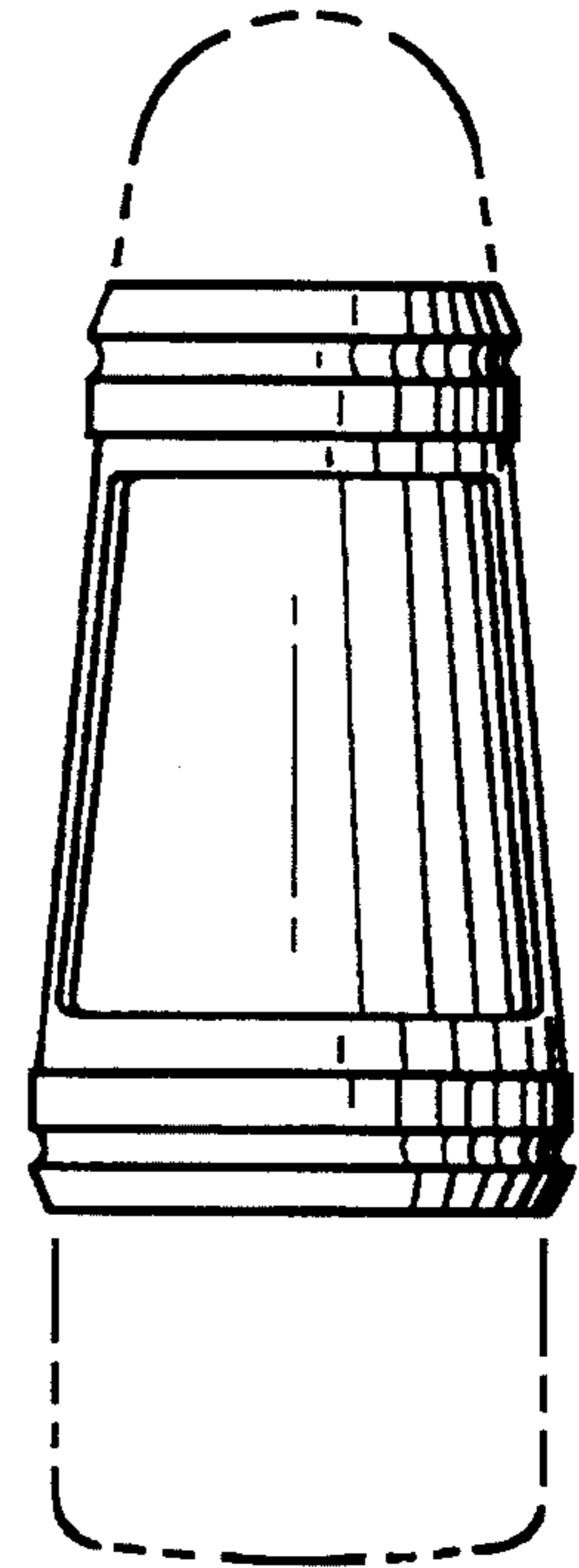

FIG. 14

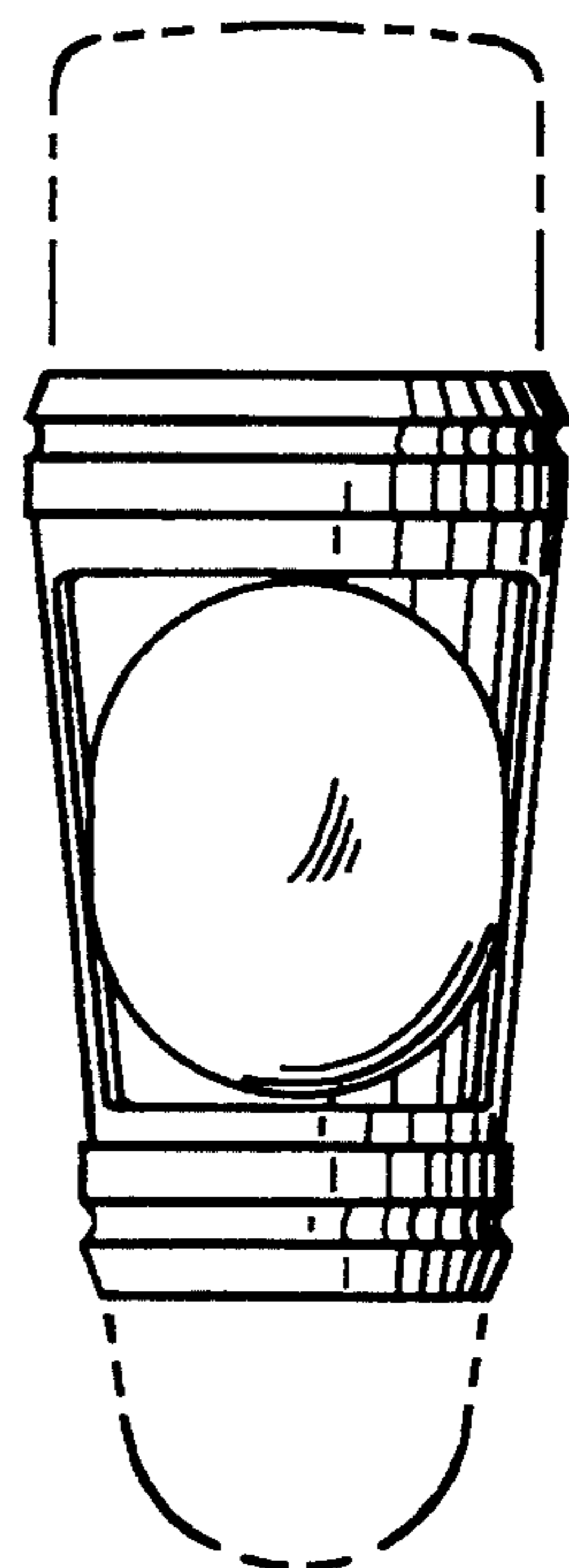

FIG. 15

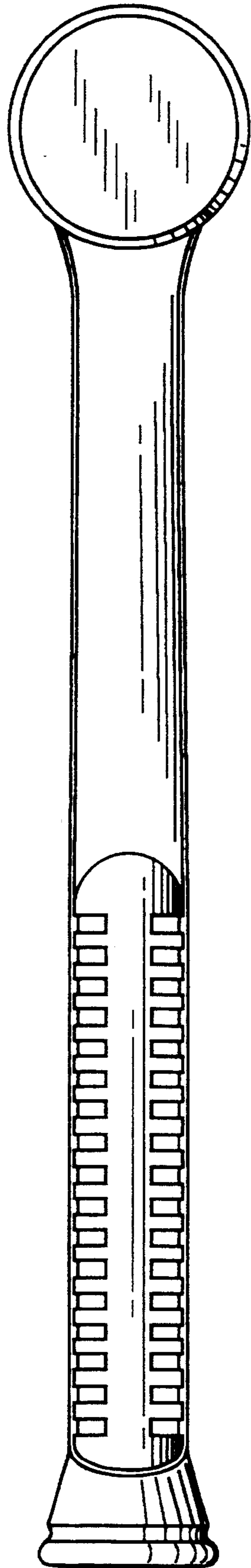

FIG. 16

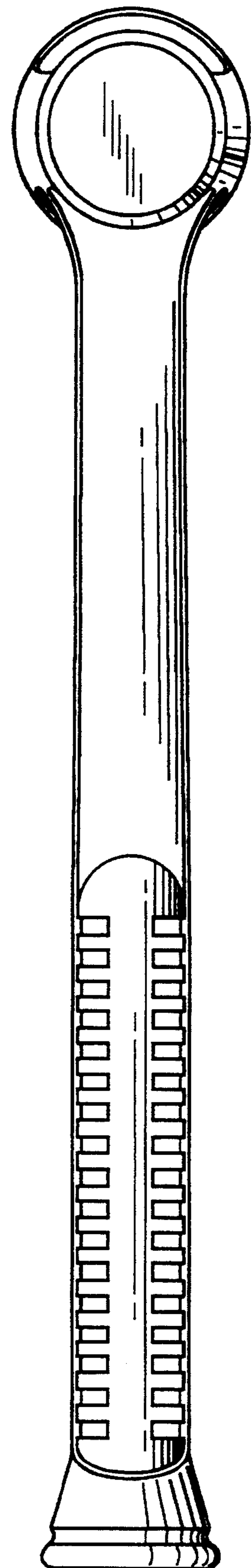

FIG. 17

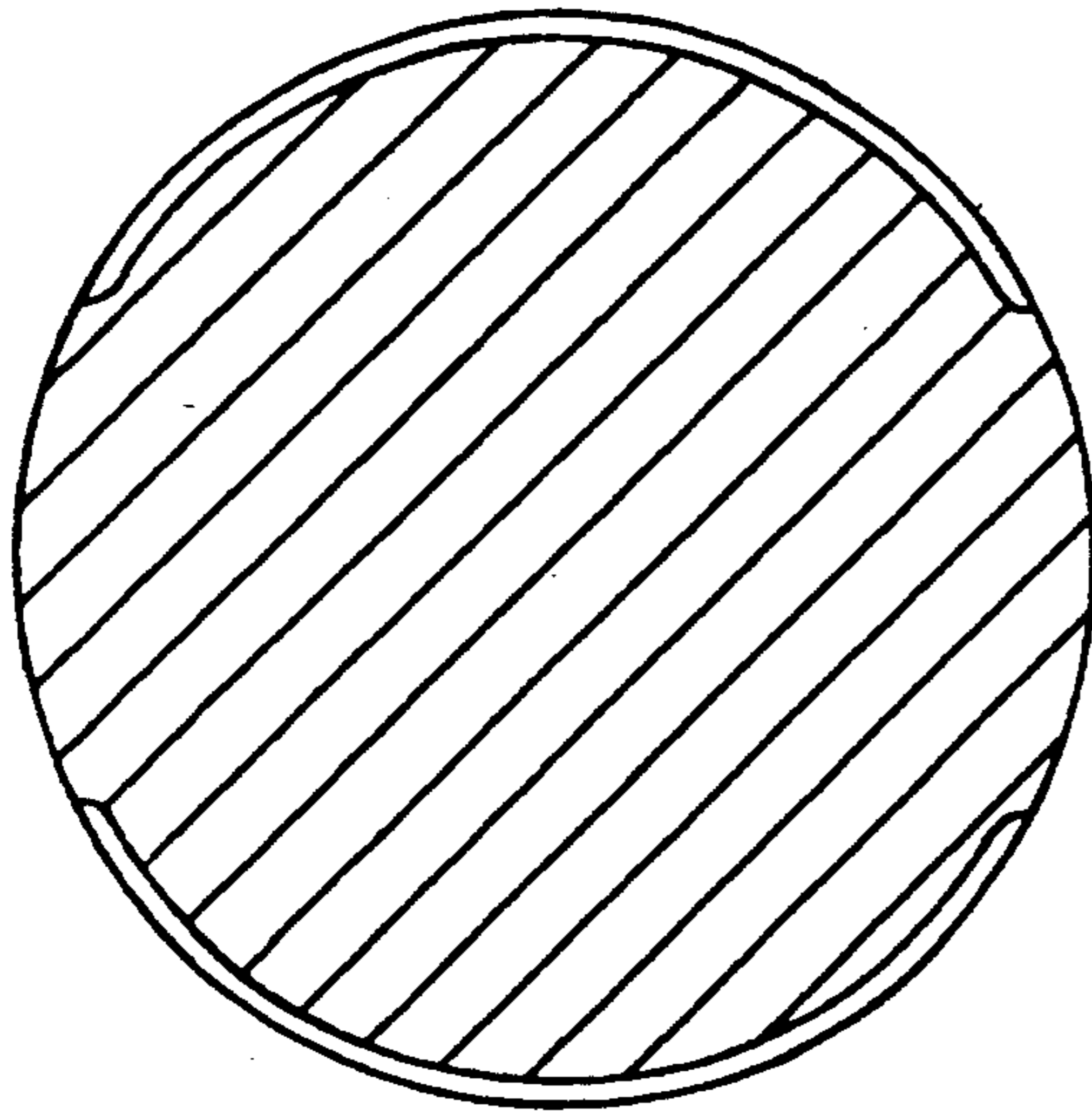

FIG. 18

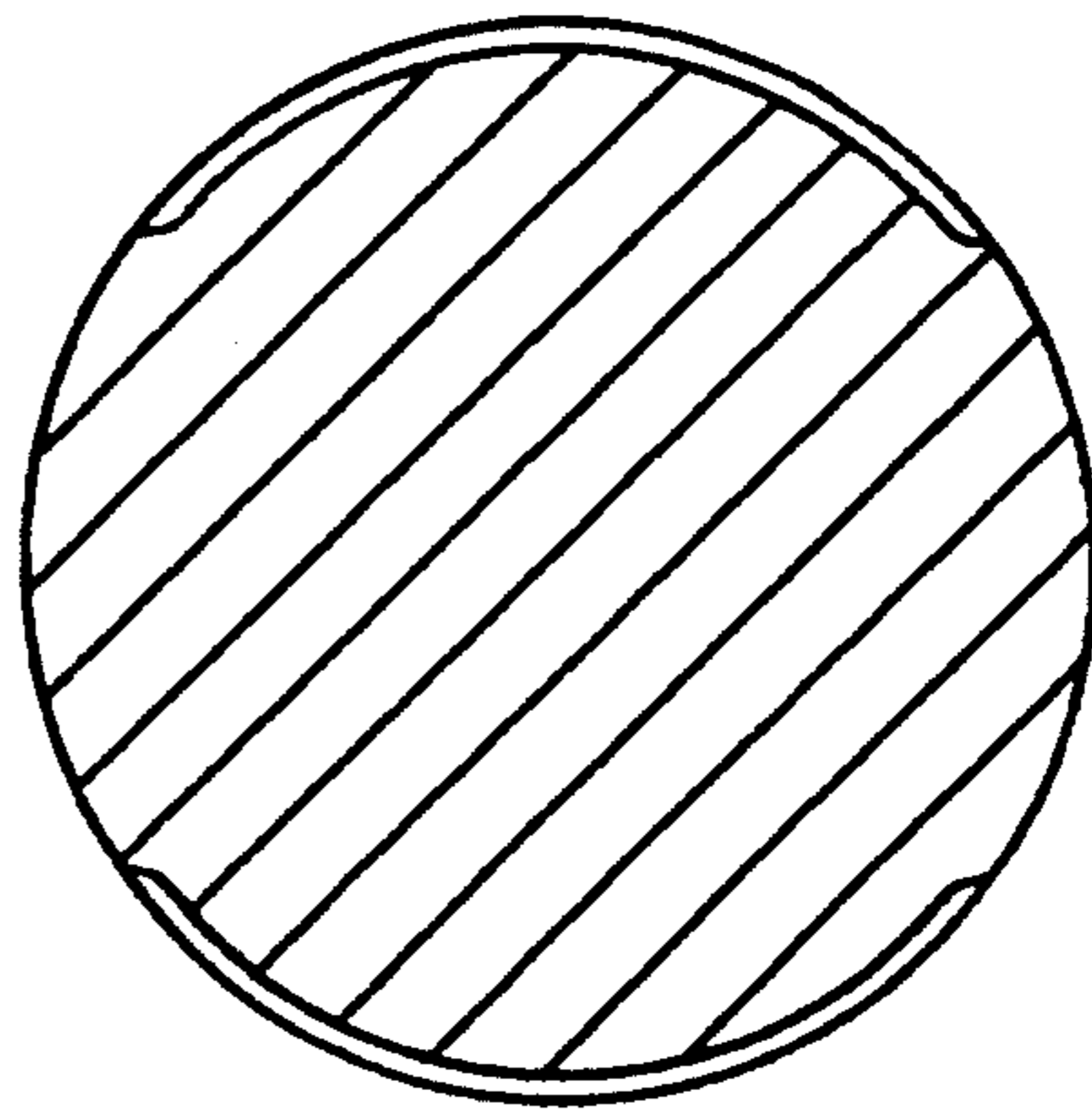

FIG. 19

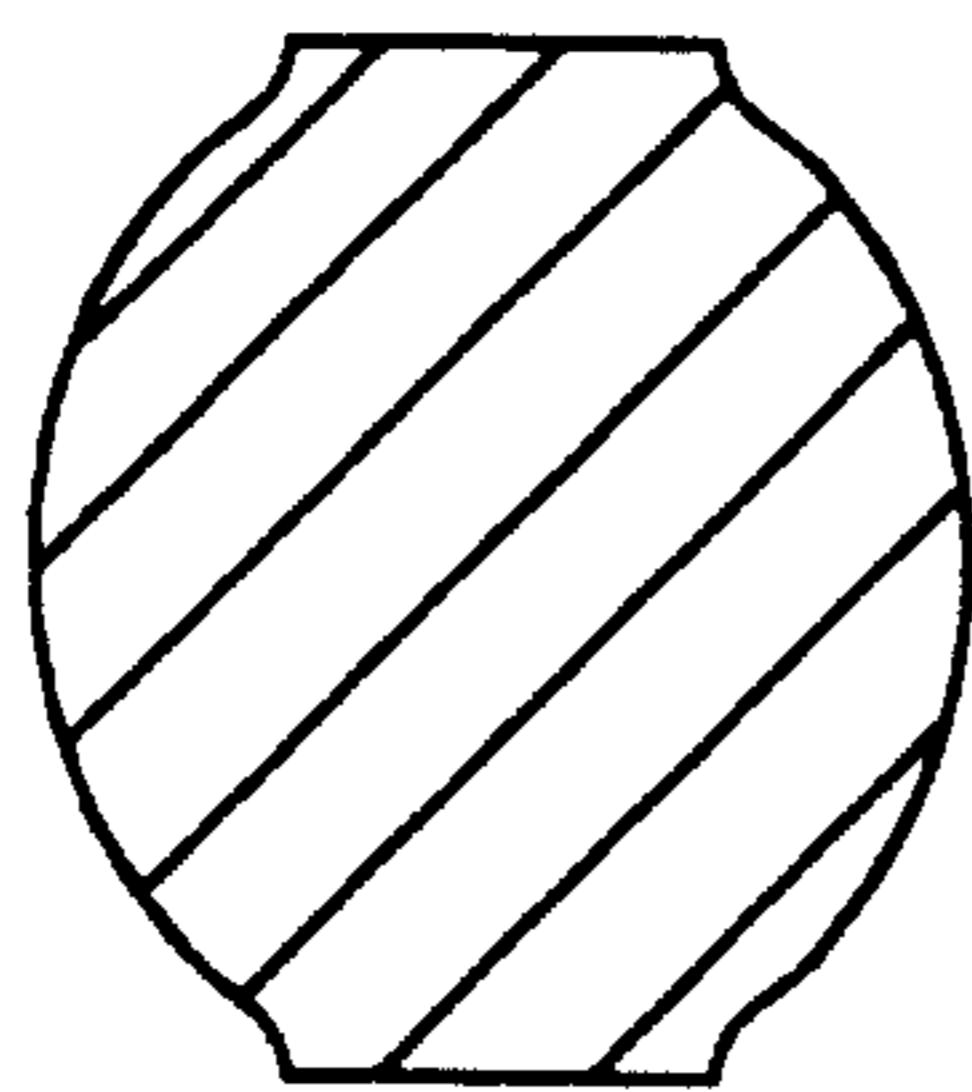

FIG. 20

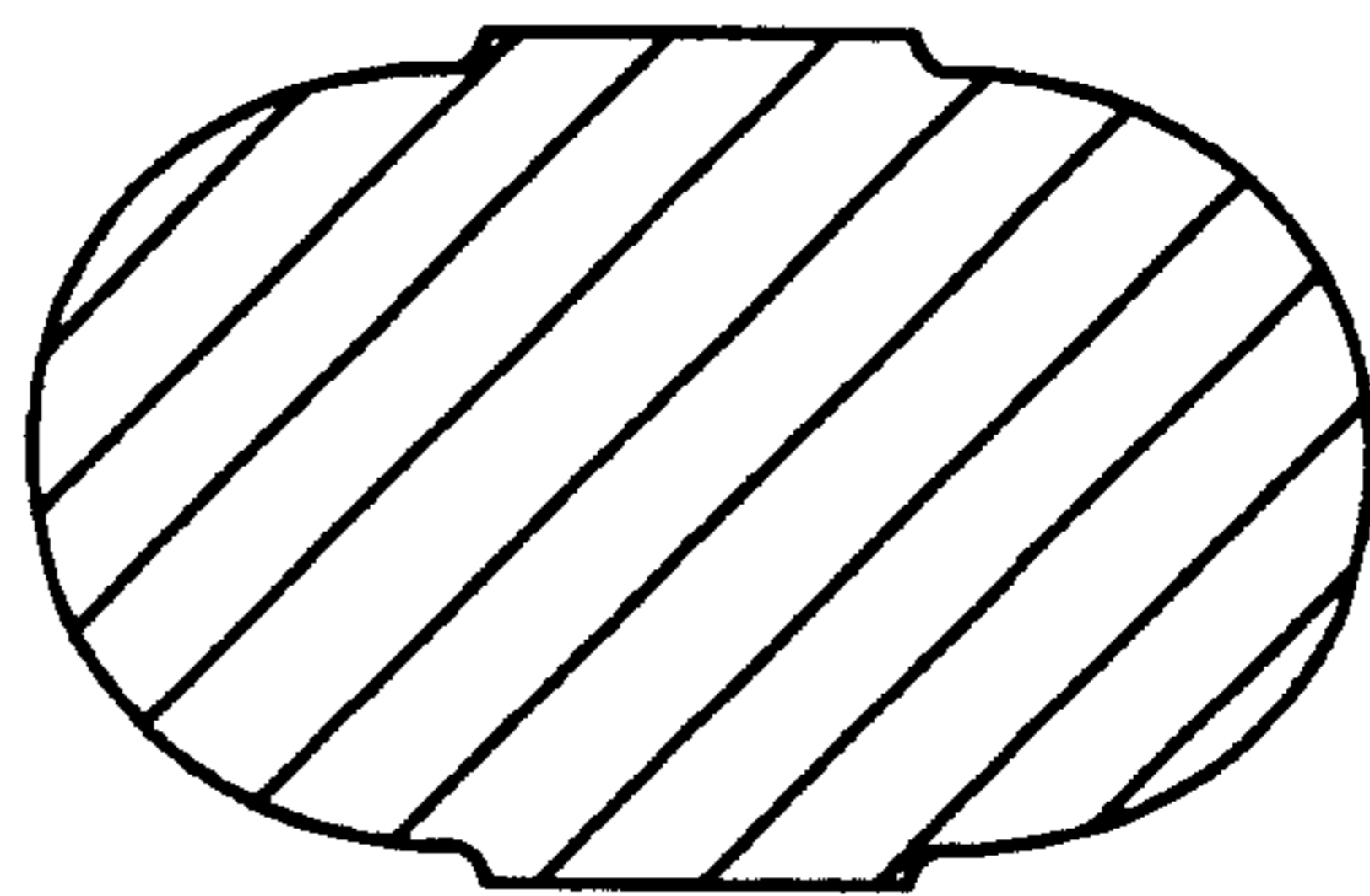

FIG. 21

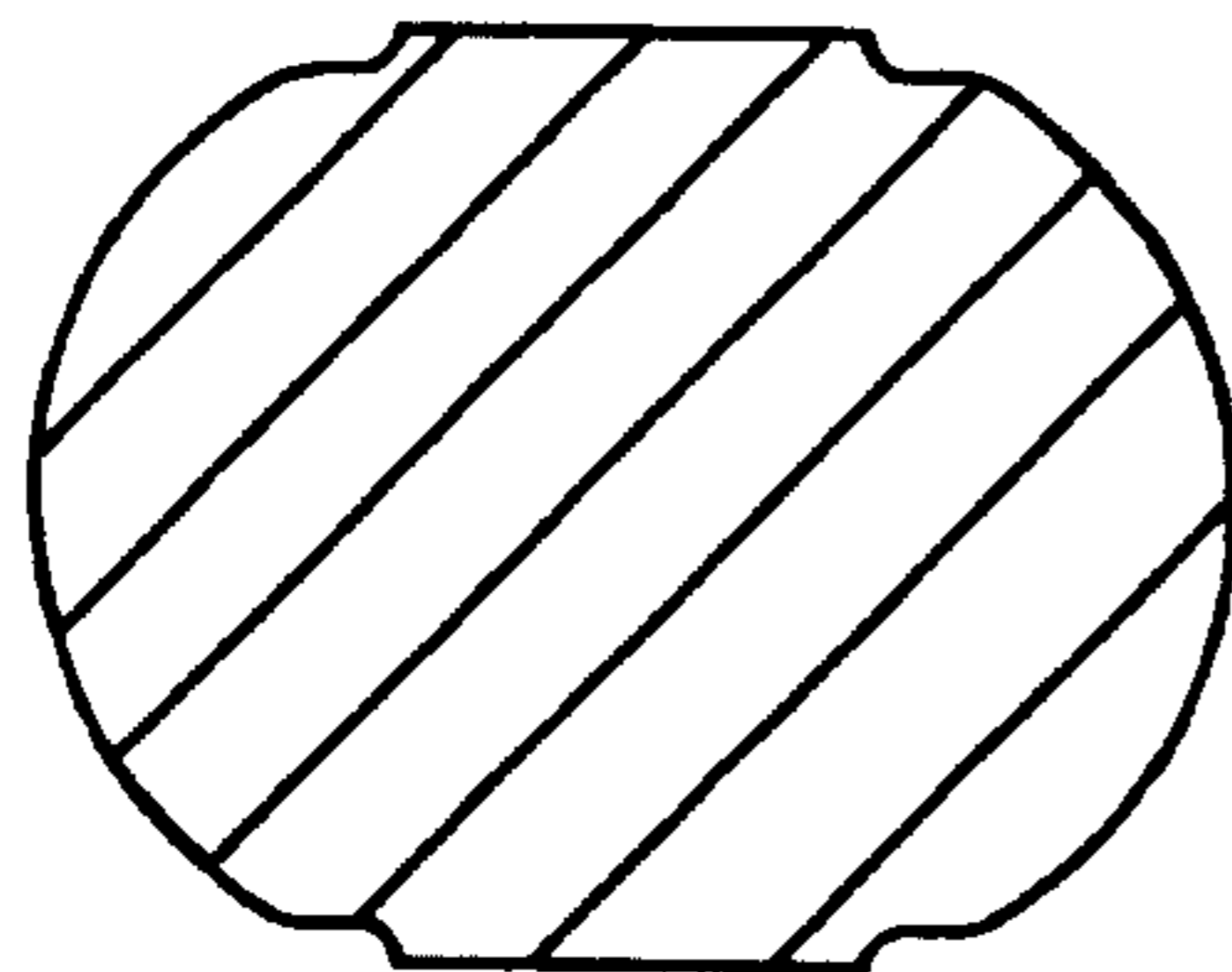

FIG. 22

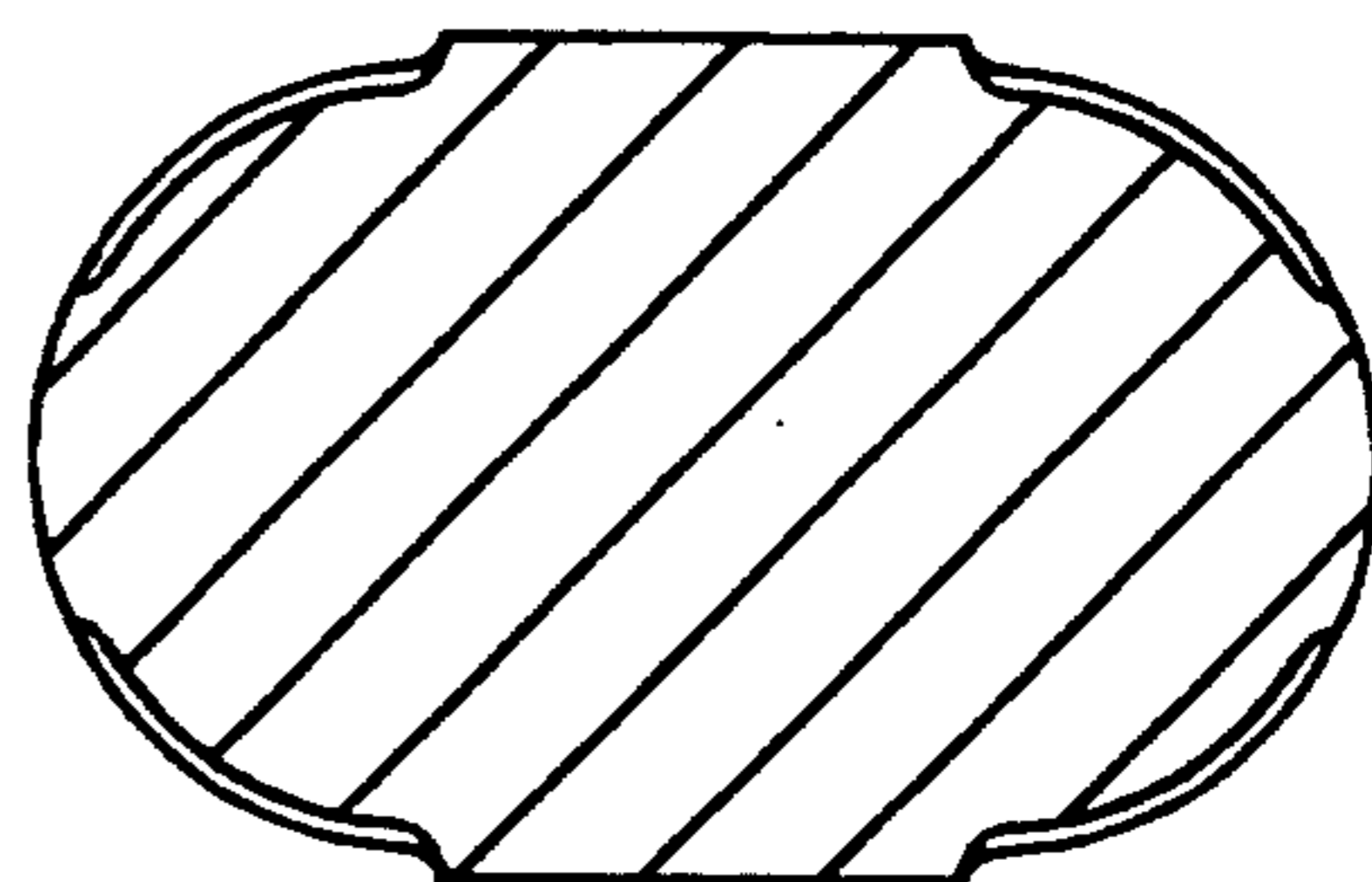

FIG. 23

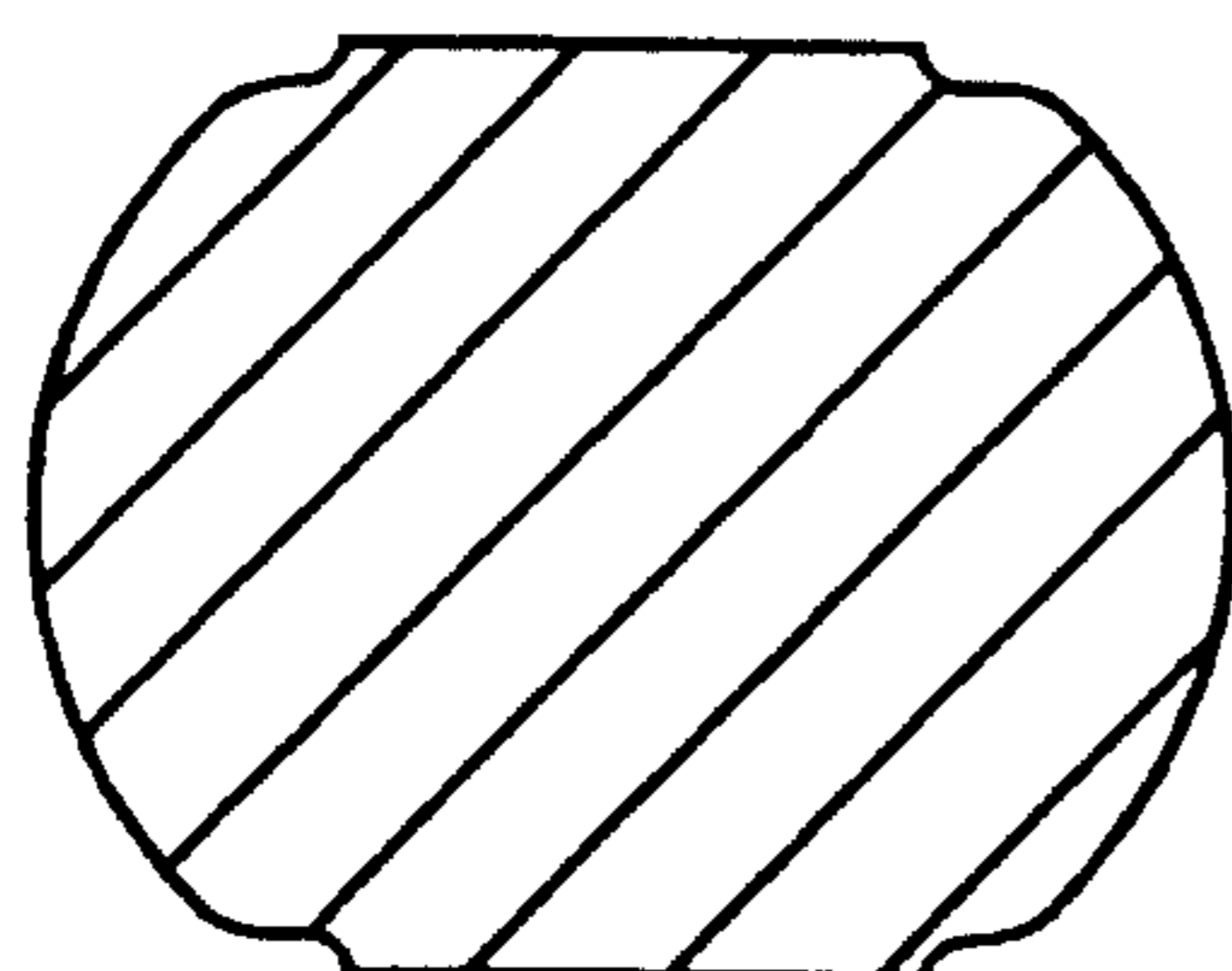

FIG. 24

