



US00D350463S

United States Patent [19]

[11] Patent Number: Des. 350,463

Hardesty, Jr.

[45] Date of Patent: ** Sep. 13, 1994

[54] LINE TRIMMER COVER WITH WHEELS

5,063,673 11/1991 Webster 30/347
5,092,112 3/1992 Buckendorf, Jr. 56/12.7
5,095,687 3/1992 Andrew et al. 56/12.7

[76] Inventor: Henry A. Hardesty, Jr., 110 Kerns Ave., Fairmont, W. Va. 26554

[**] Term: 14 Years

Primary Examiner—Bernard Ansher
Assistant Examiner—Sandra Morris
Attorney, Agent, or Firm—Hugh E. Smith

[21] Appl. No.: 847,243

[57] CLAIM

[22] Filed: Feb. 27, 1992

The ornamental design for a line trimmer cover with wheels, as shown and described.

[52] U.S. Cl. D8/8

[58] Field of Search D8/8; 30/276, 390, DIG. 5; 56/12.7, 234, 239, 249, 255, 289, 295; D15/14-18

DESCRIPTION

[56] References Cited

U.S. PATENT DOCUMENTS

D. 254,008	1/1980	Jackson	D15/17
D. 301,009	5/1989	Pilatowicz et al.	D8/8
4,182,100	1/1980	Letter	56/16.7
4,285,128	8/1981	Schnell et al.	56/12.7
4,442,659	4/1984	Ehbusk	56/12.7
4,862,682	9/1989	Wait et al.	56/255
4,922,694	5/1990	Emoto	56/12.7

FIG. 1 is a front elevational view of the line trimmer cover with wheels showing my new design; FIG. 2 is a rear elevational view thereof; FIG. 3 is a left side elevational view thereof; FIG. 4 is a right side elevational view thereof; FIG. 5 is a top plan view thereof; FIG. 6 is a bottom plan view thereof; and, FIG. 7 is a left side elevational view of the invention in use, the broken line showing of the line trimmer is for illustrative purposes only, and forms no part of the claimed design.

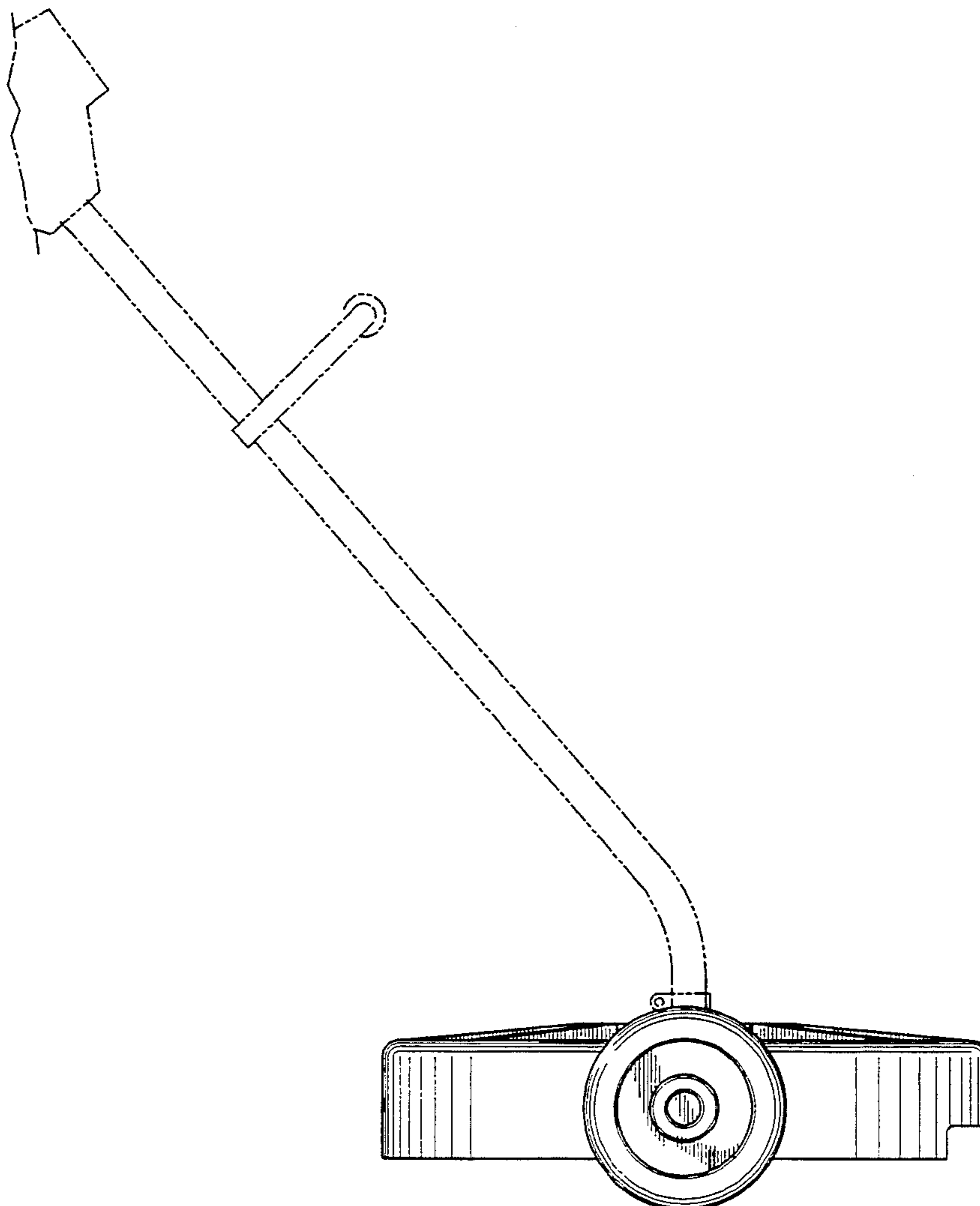

FIG. 1

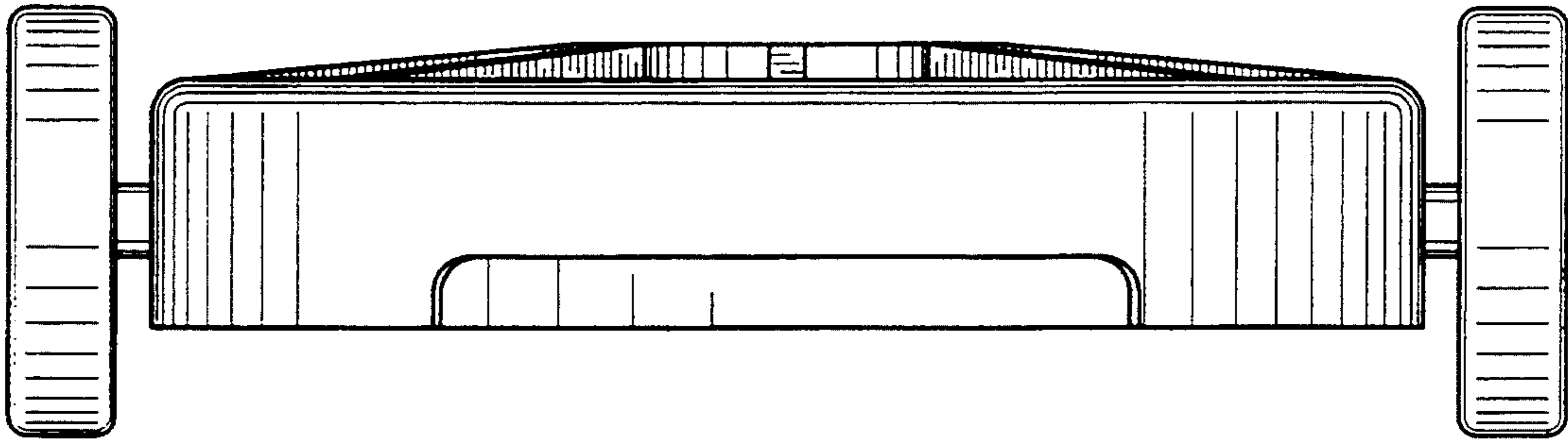

FIG. 2

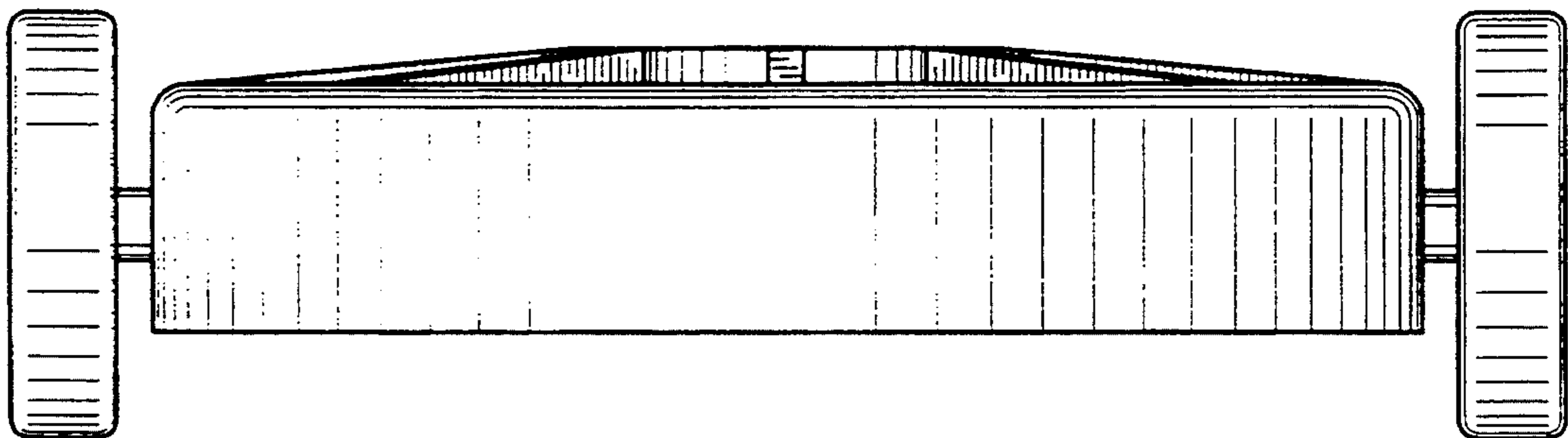

FIG. 3

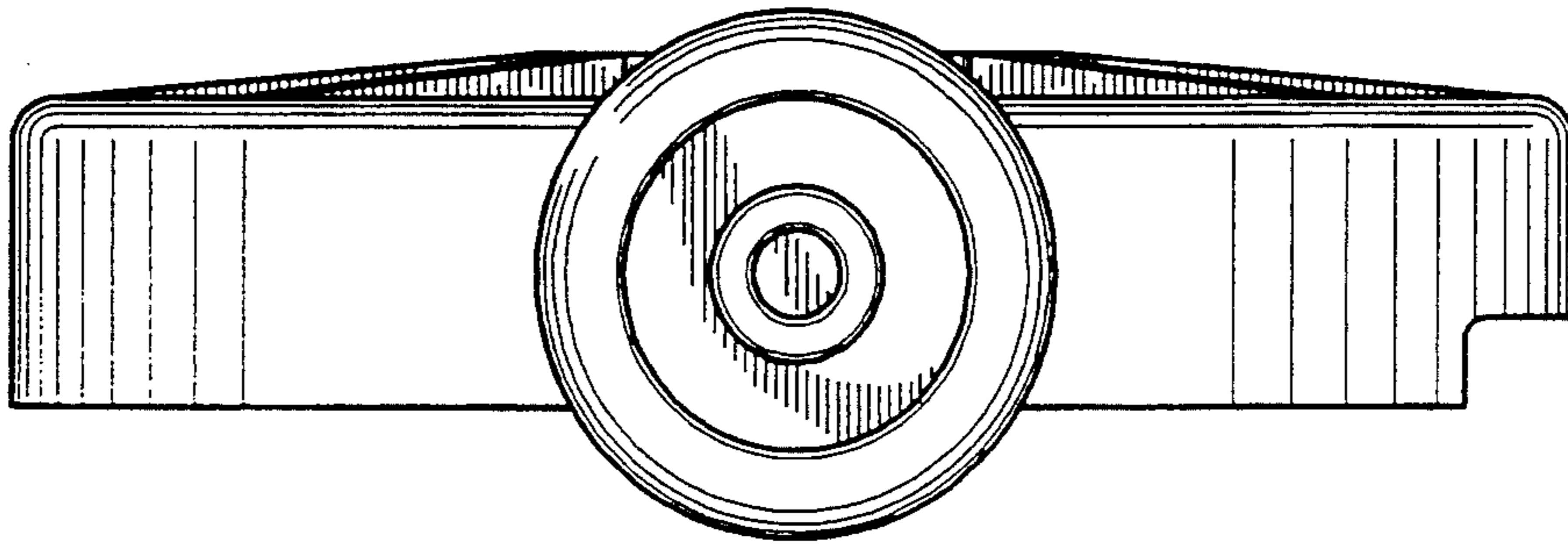

FIG. 4

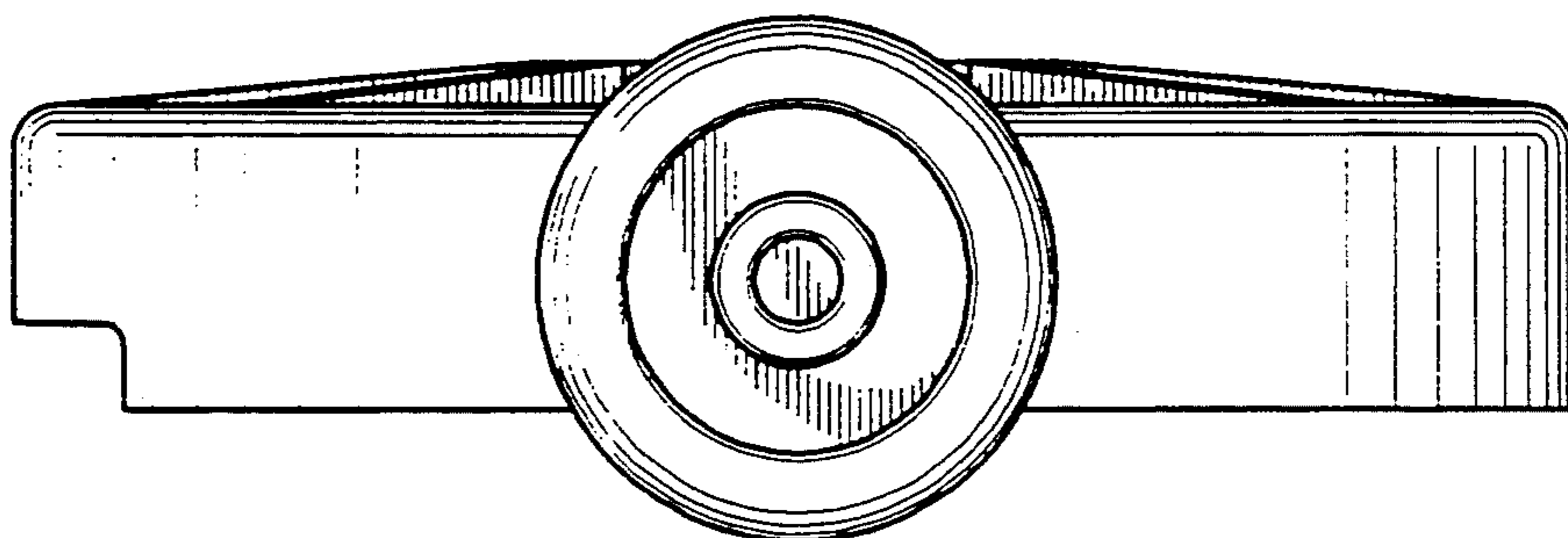

FIG. 5

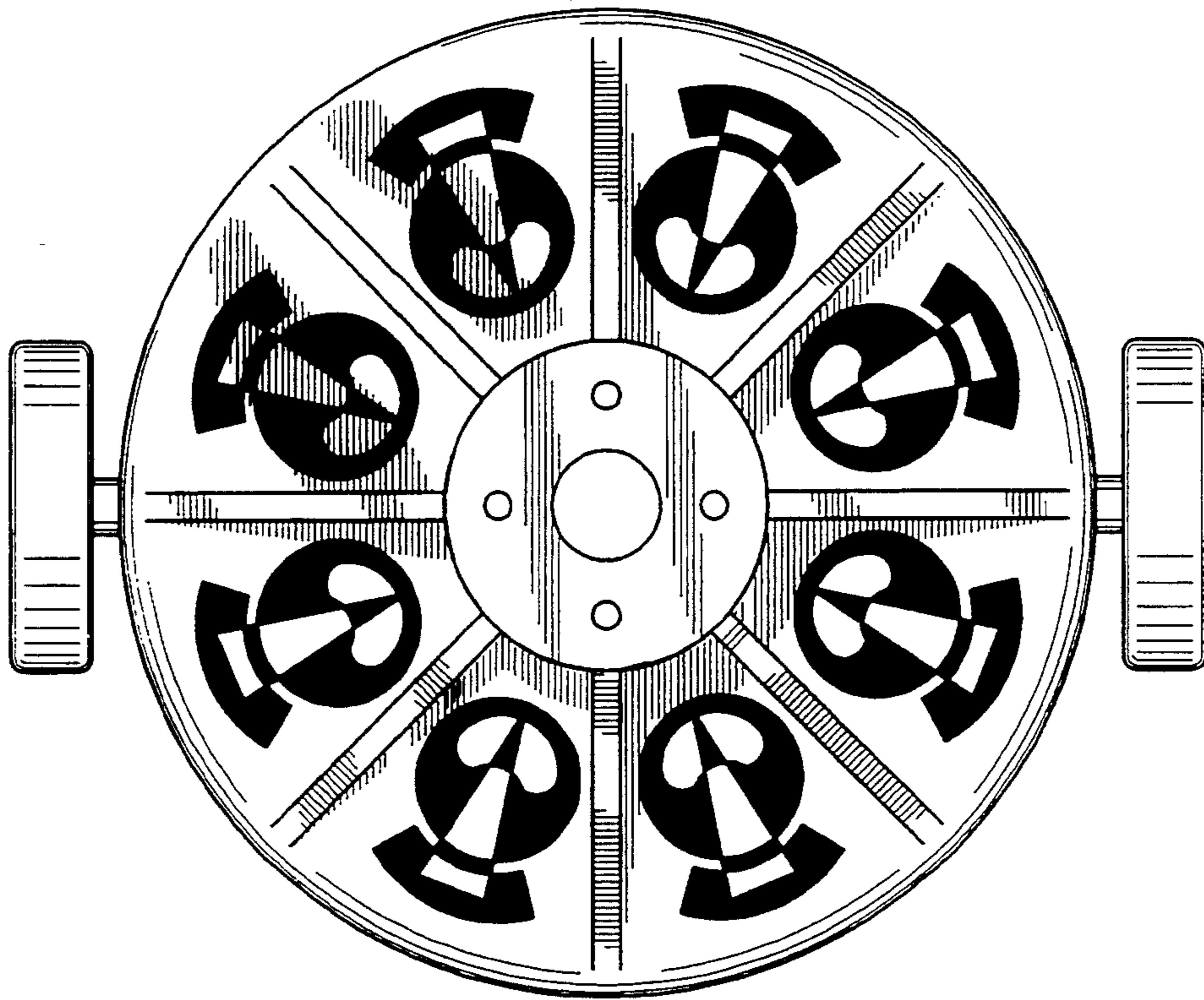

FIG. 6

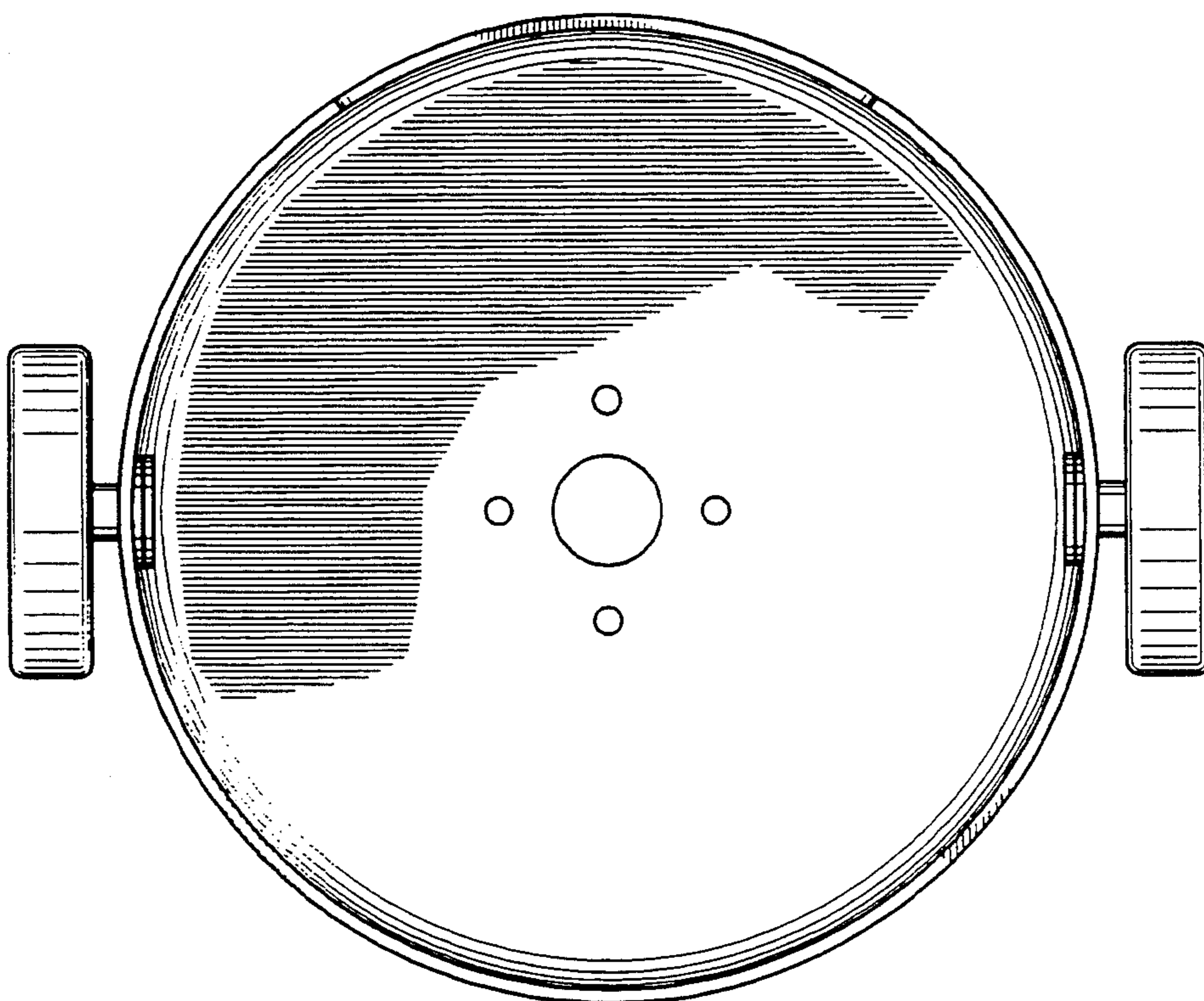

FIG. 7

