



US00D350437S

United States Patent [19]

[11] Patent Number: **Des. 350,437**

Apps et al.

[45] Date of Patent: **** Sep. 13, 1994**

[54] **FULL DEPTH CRATE**

[57] **CLAIM**

[75] Inventors: **William P. Apps, Anaheim; Gerald R. Koefeldt, Seal Beach, both of Calif.; Larry E. Shermer, Atlanta, Ga.**

The ornamental design for a full depth crate, as shown and described.

[73] Assignees: **Rehrig Pacific Company, Inc., Los Angeles, Calif.; The Coca-Cola Company, Atlanta, Ga.**

DESCRIPTION

[**] Term: **14 Years**

FIG. 1 is a top plan view of a full depth crate showing our new design;
FIG. 2 is a front elevational view thereof;
FIG. 3 is a rear elevational view thereof;
FIG. 4 is a right side elevational view thereof;
FIG. 5 is a left side elevational view thereof;
FIG. 6 is a bottom plan view thereof;
FIG. 7 is a sectional elevational view taken along line 7—7 of FIG. 6;
FIG. 8 is a sectional elevational view taken along line 8—8 of FIG. 6;
FIG. 9 is a sectional plan view taken along line 9—9 of FIG. 3, the bottom support being eliminated for clarity of illustration;
FIG. 10 is a fragmentary enlarged scale sectional view taken along line 10—10 of FIG. 7;
FIG. 11 is a fragmentary enlarged scale sectional view taken along line 11—11 of FIG. 7;
FIG. 12 is a fragmentary enlarged scale sectional view taken along line 12—12 of FIG. 6;
FIG. 13 is a fragmentary enlarged scale sectional view taken along line 13—13 of FIG. 6;
FIG. 14 is a fragmentary enlarged scale sectional view taken along line 14—14 of FIG. 1; and,
FIG. 15 is a fragmentary enlarged scale sectional view taken along line 15—15 of FIG. 1.

[21] Appl. No.: **1,587**

[22] Filed: **Nov. 19, 1992**

[52] U.S. Cl. **D3/304**

[58] Field of Search **D9/424, 425, 341; 206/503, 504, 505, 508, 509, 518, 427; 220/1.5, 23.6, 255, 338, 675, 669, DIG. 15; D34/40-46**

[56] **References Cited**

U.S. PATENT DOCUMENTS

D. 265,009	6/1982	Box	D34/40
D. 275,142	8/1984	Torokvei	D34/40
D. 318,552	7/1991	Apps	D34/40
3,841,519	10/1974	Stromberg	206/509 X
3,997,074	12/1976	Shed	220/645

Primary Examiner—Prabhakar G. Deshmukh
Attorney, Agent, or Firm—Banner, Birch, McKie & Beckett

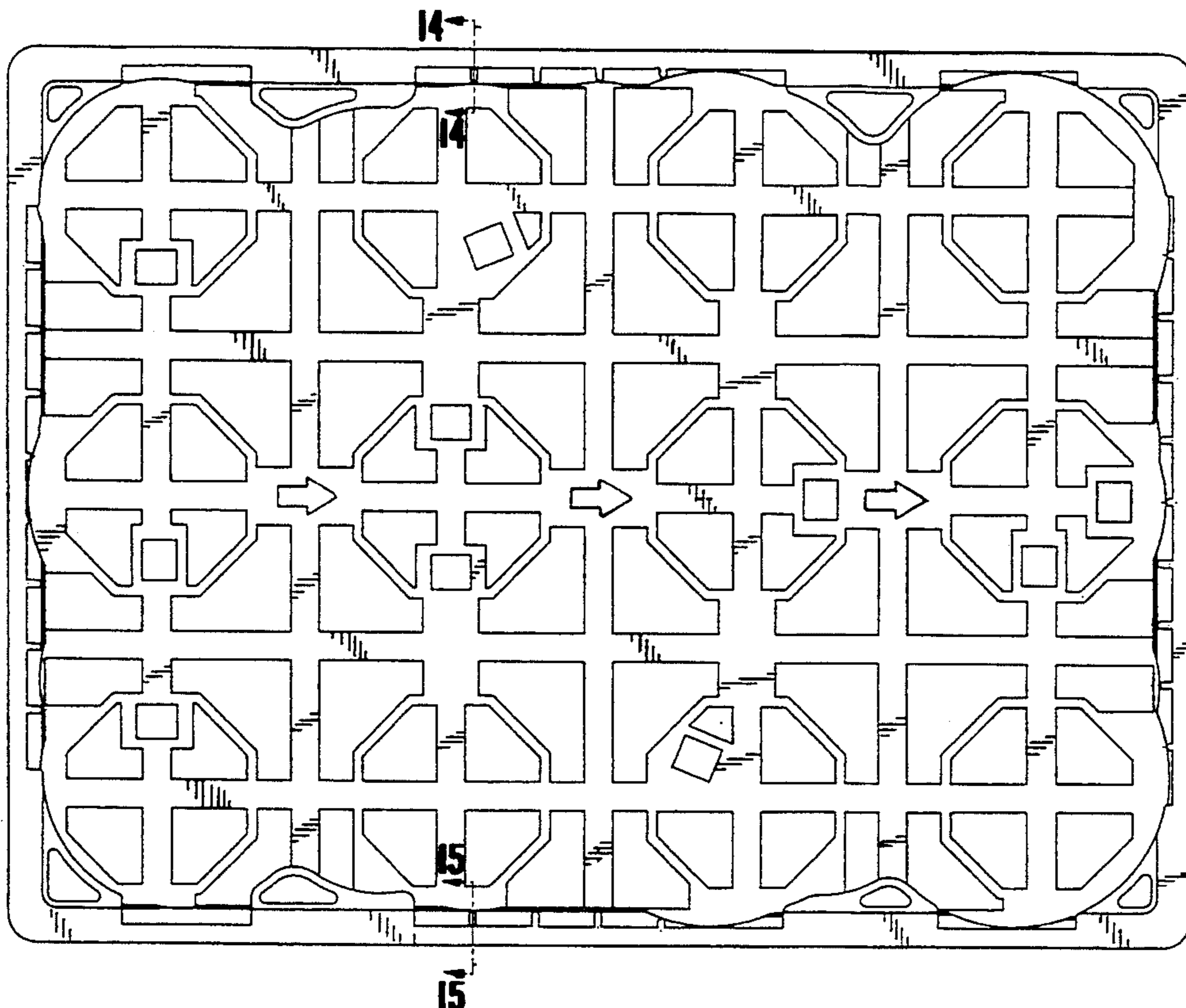

FIG. 1

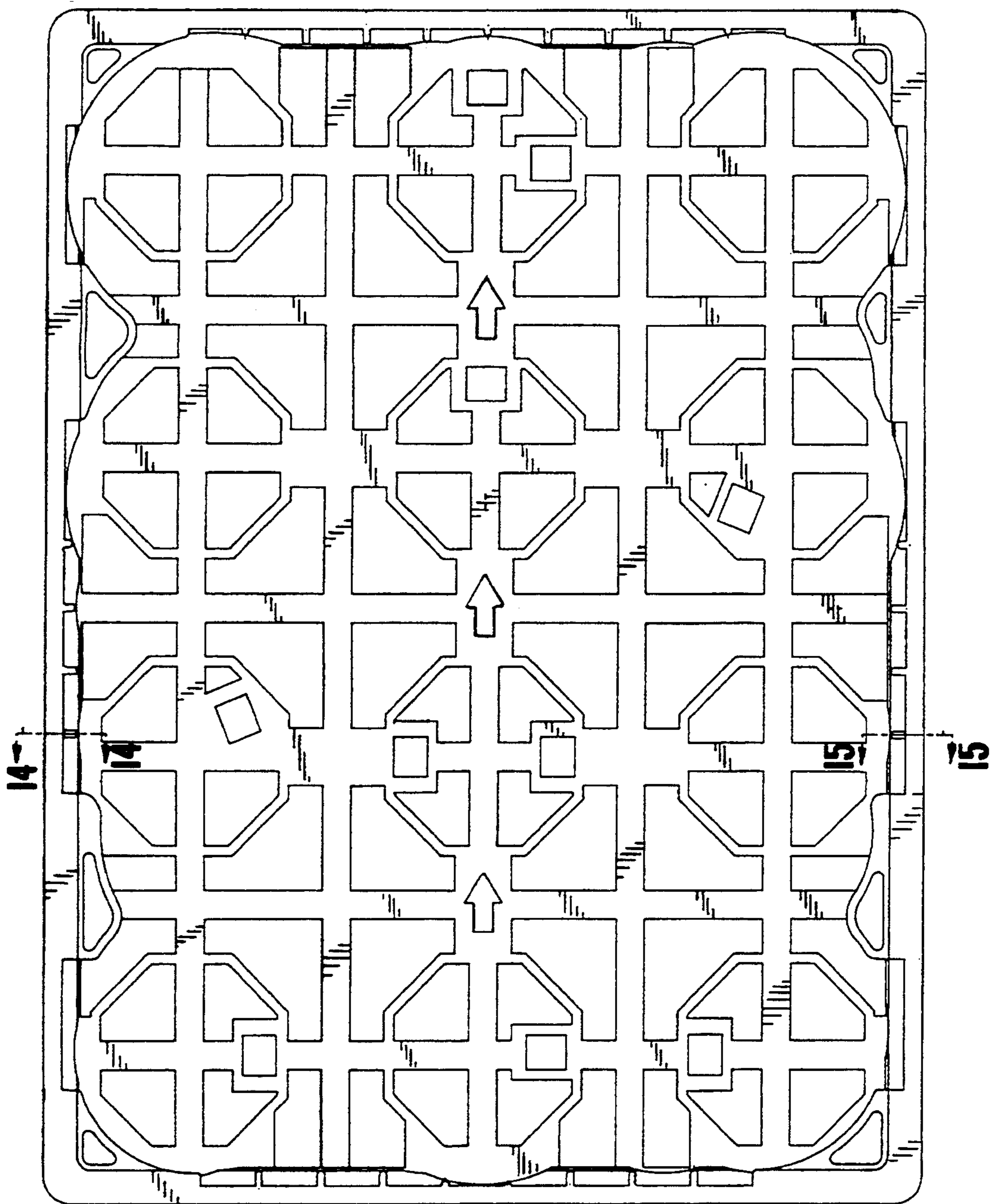

FIG. 2

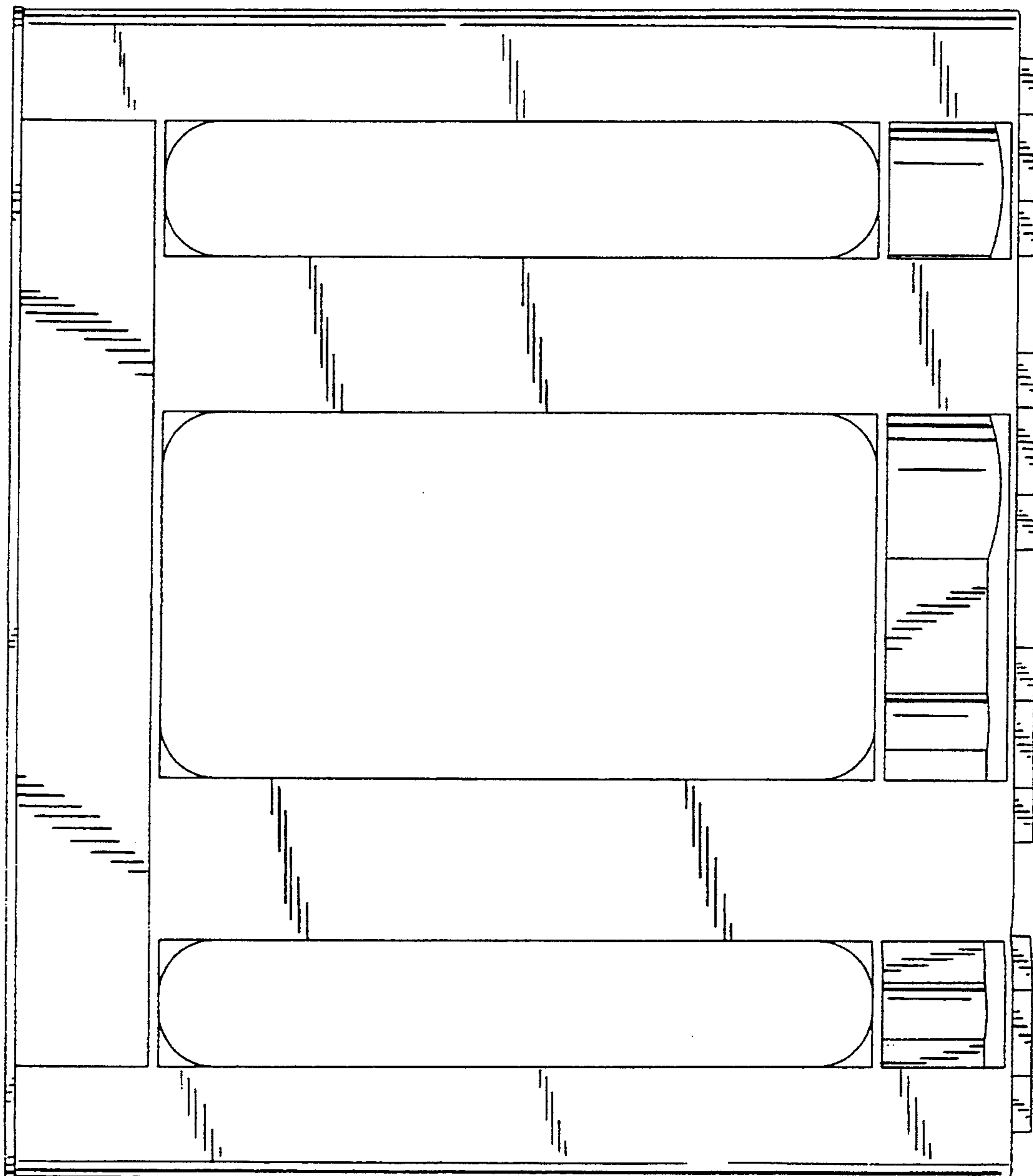

FIG. 3

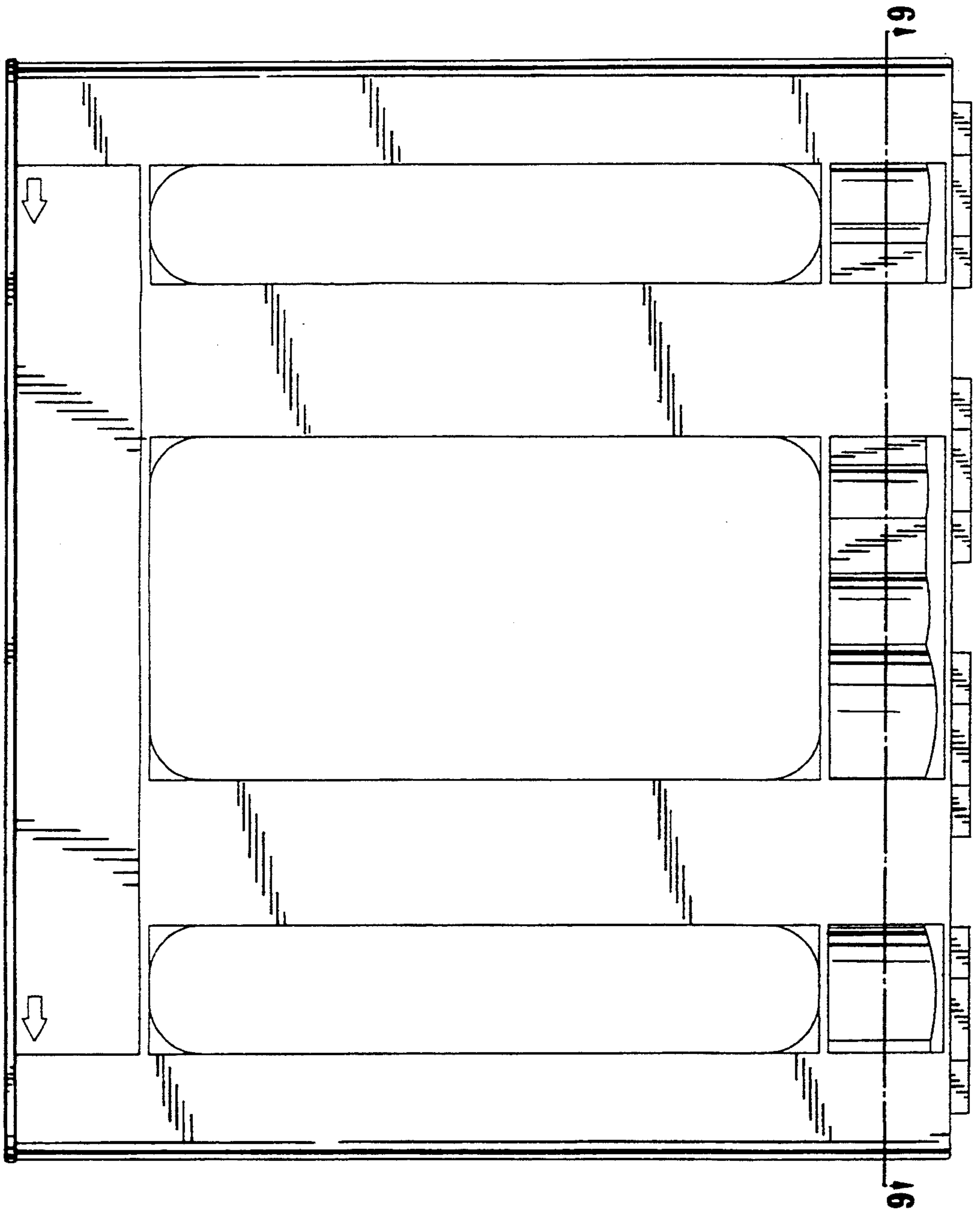

FIG. 4

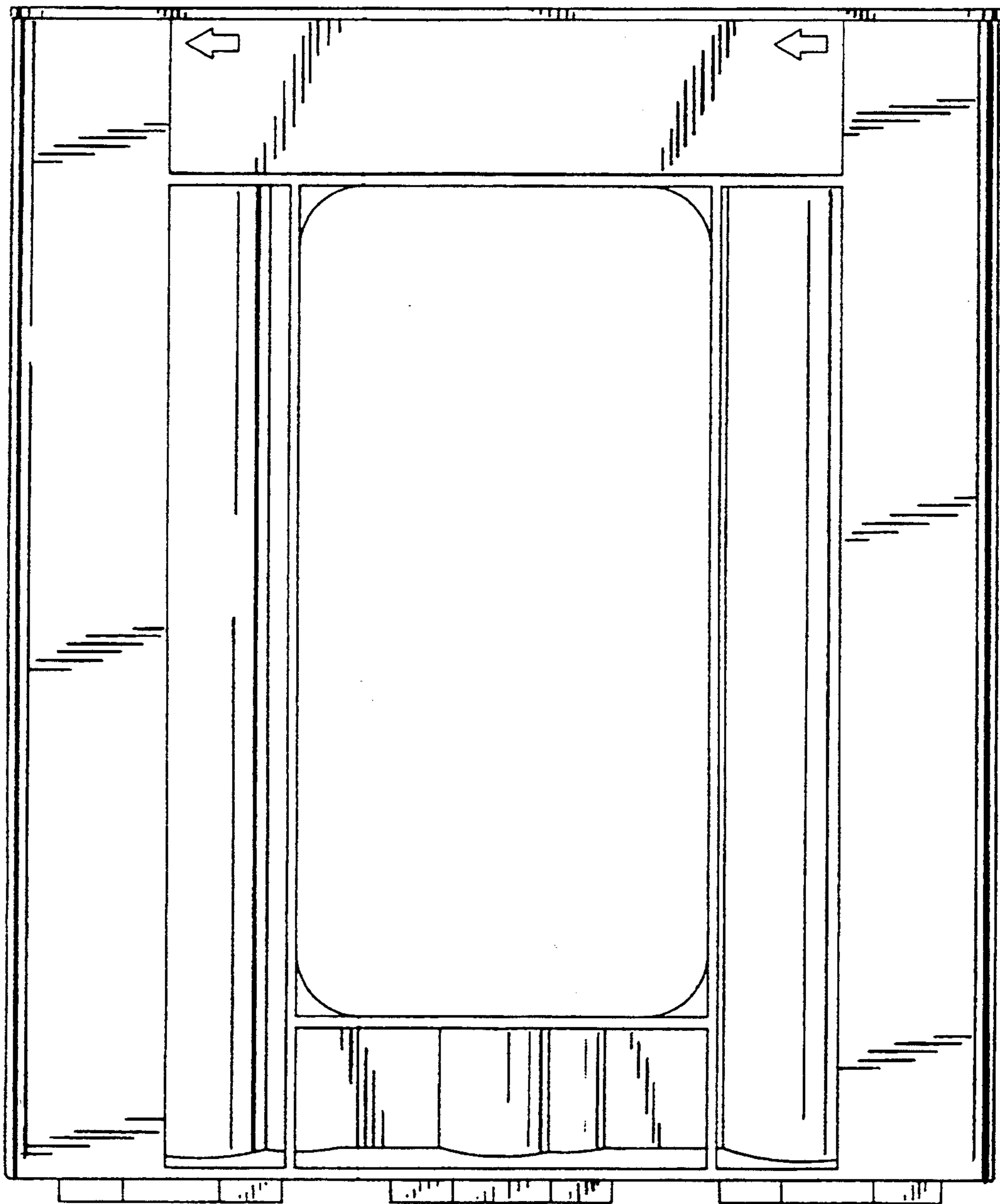

FIG. 5

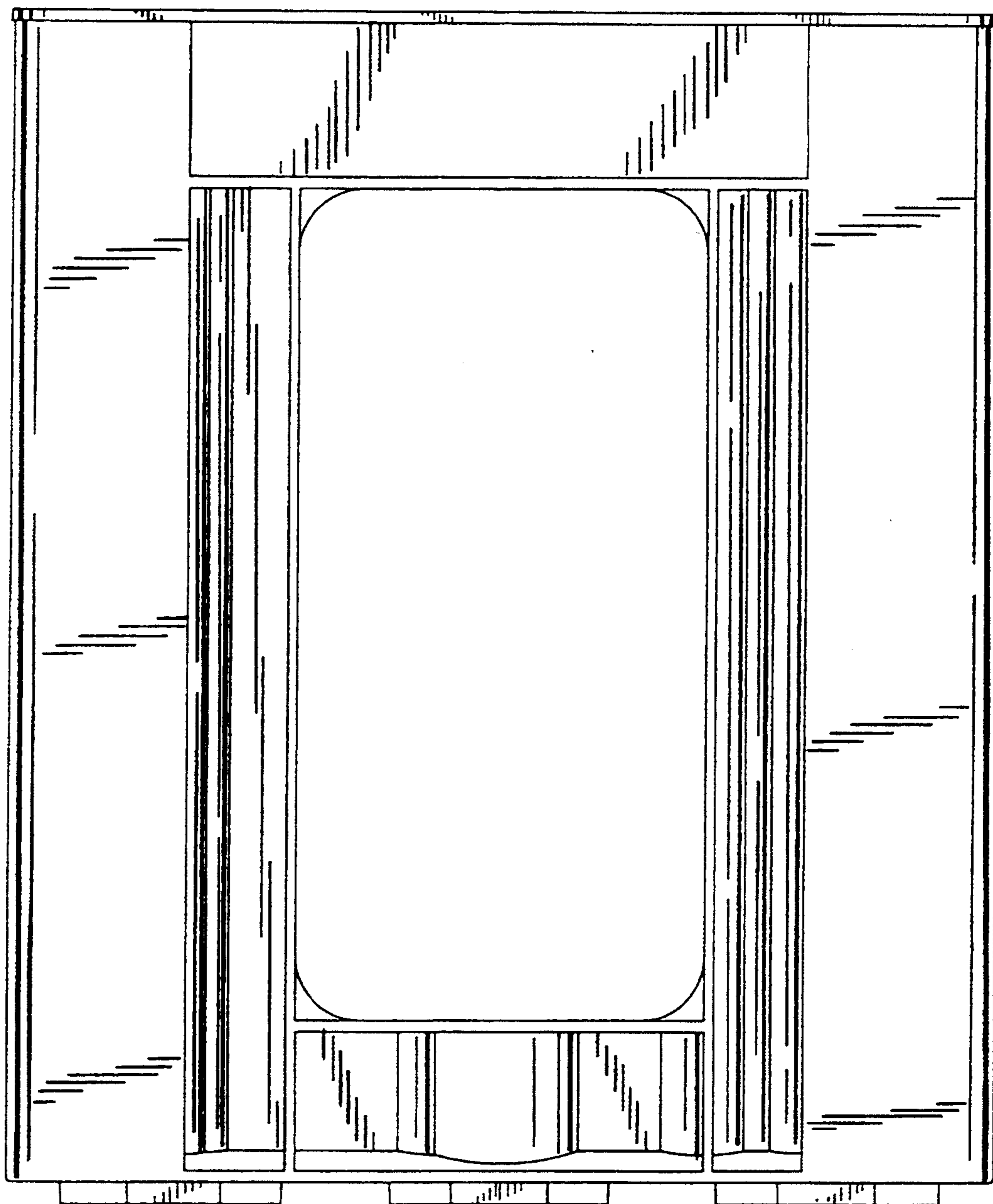

FIG. 6

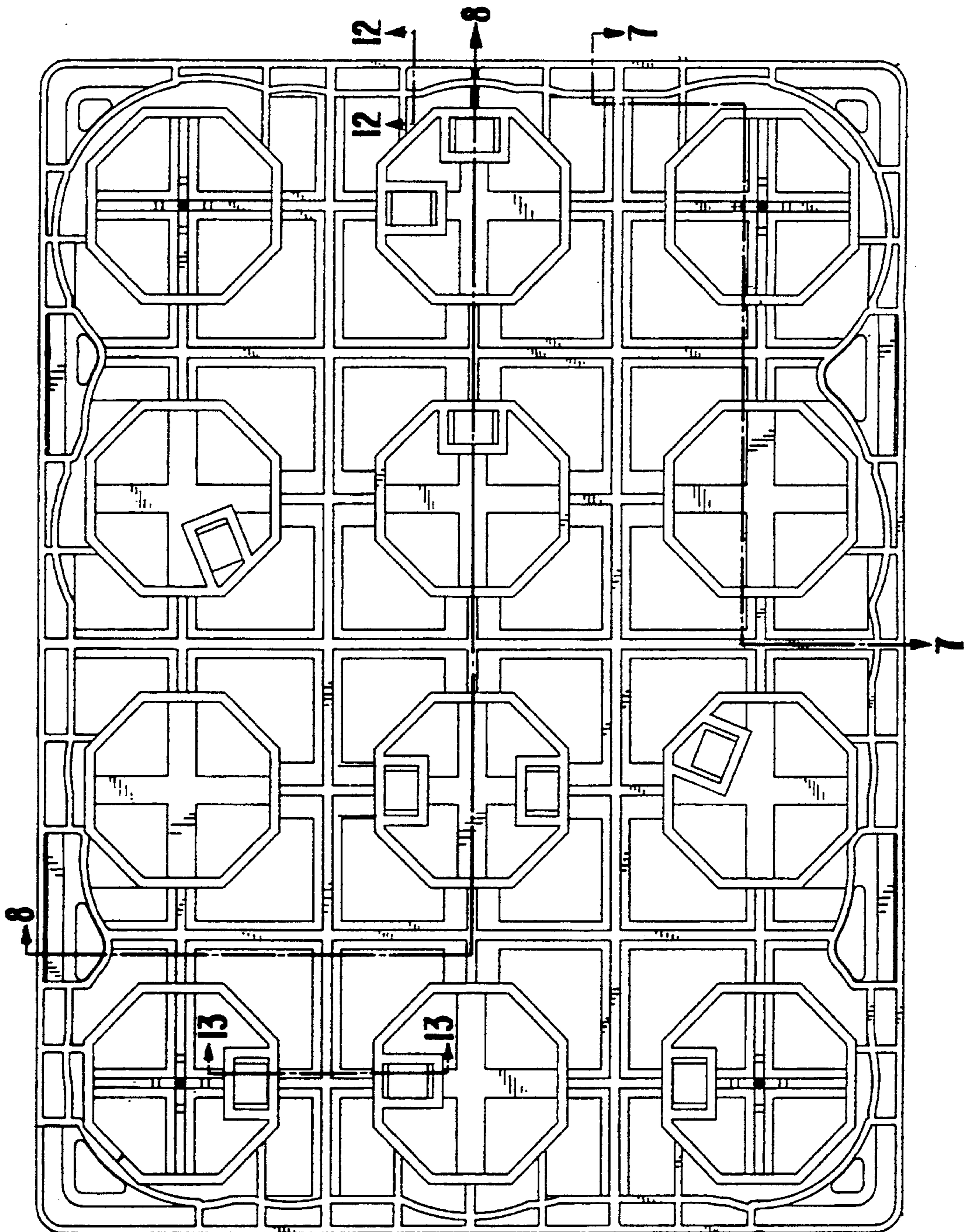

FIG. 8

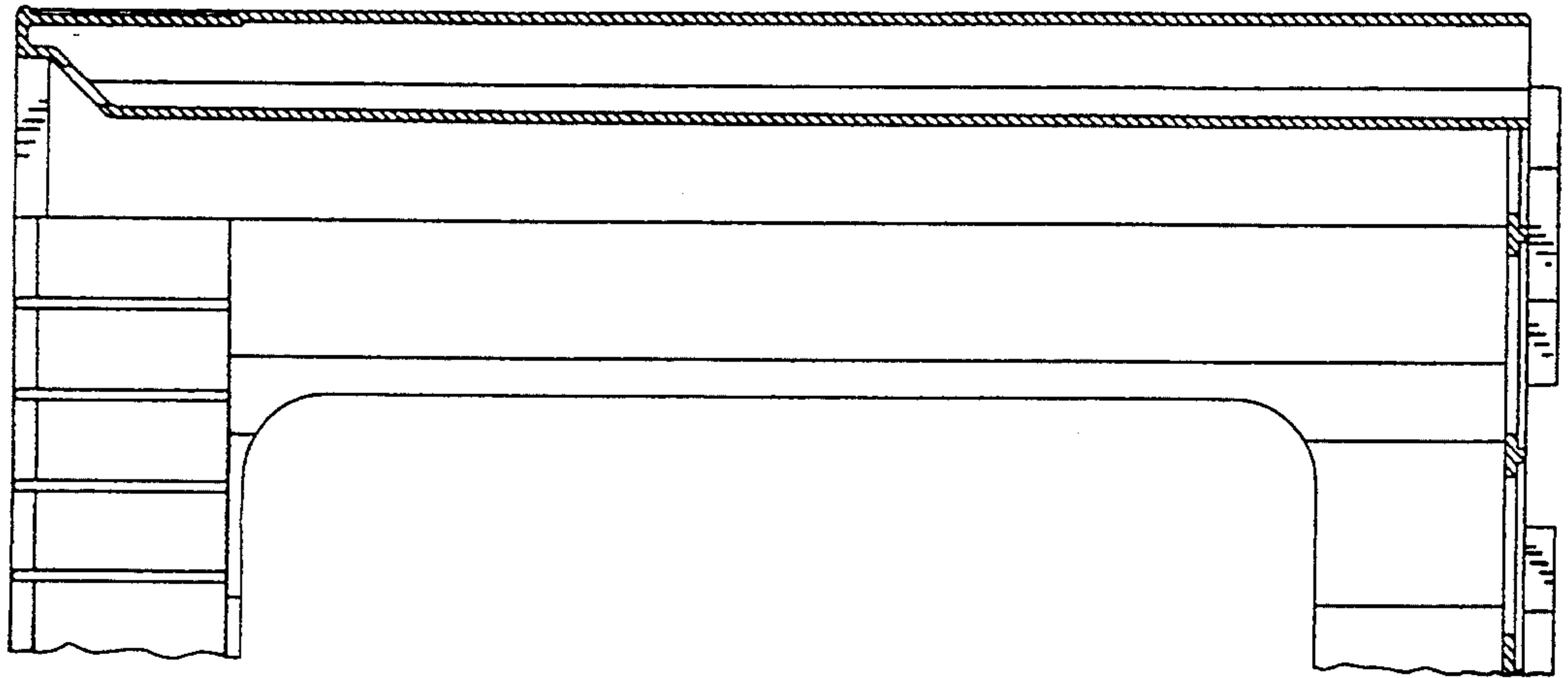

FIG. 7

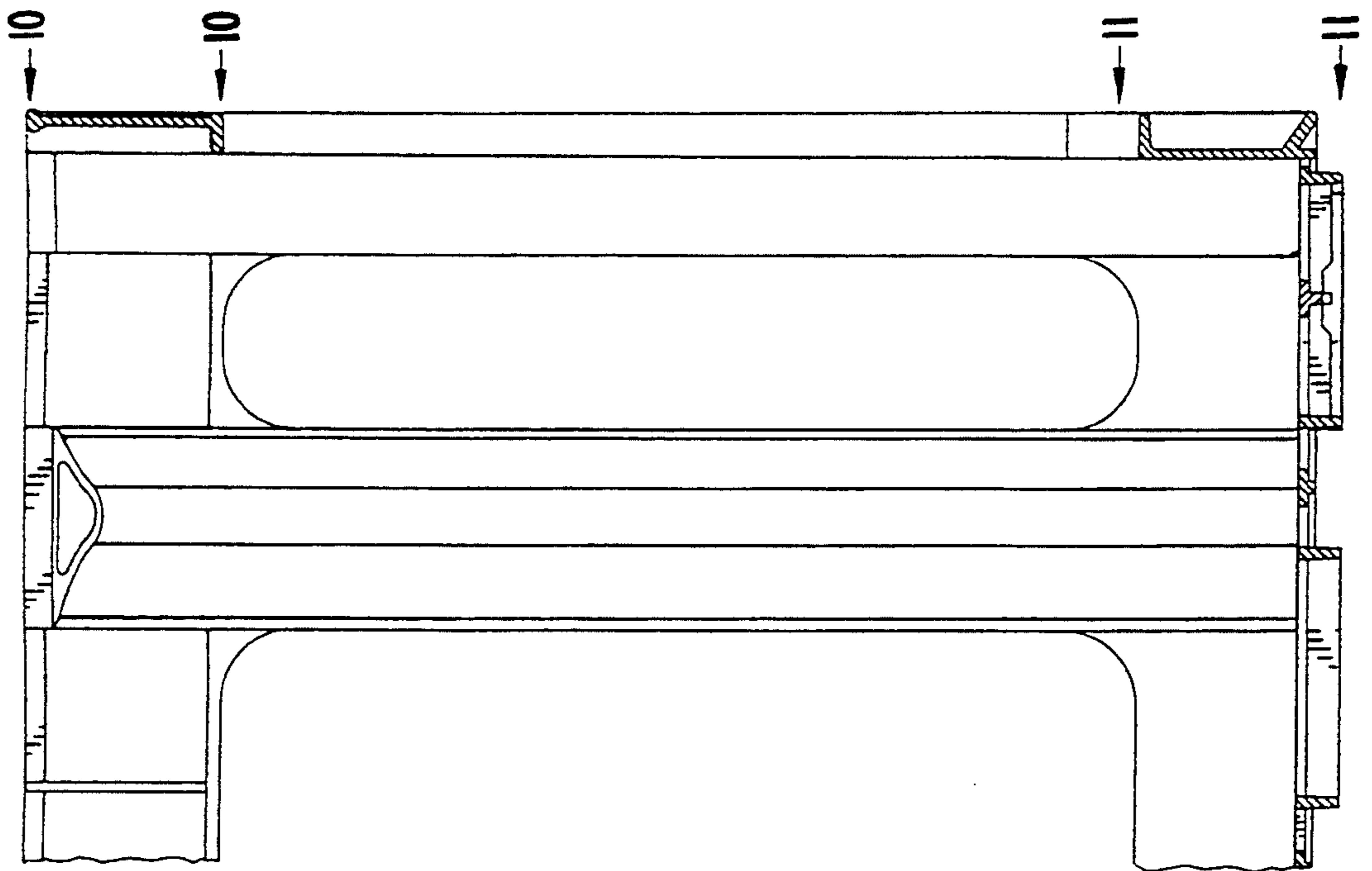

FIG. 9

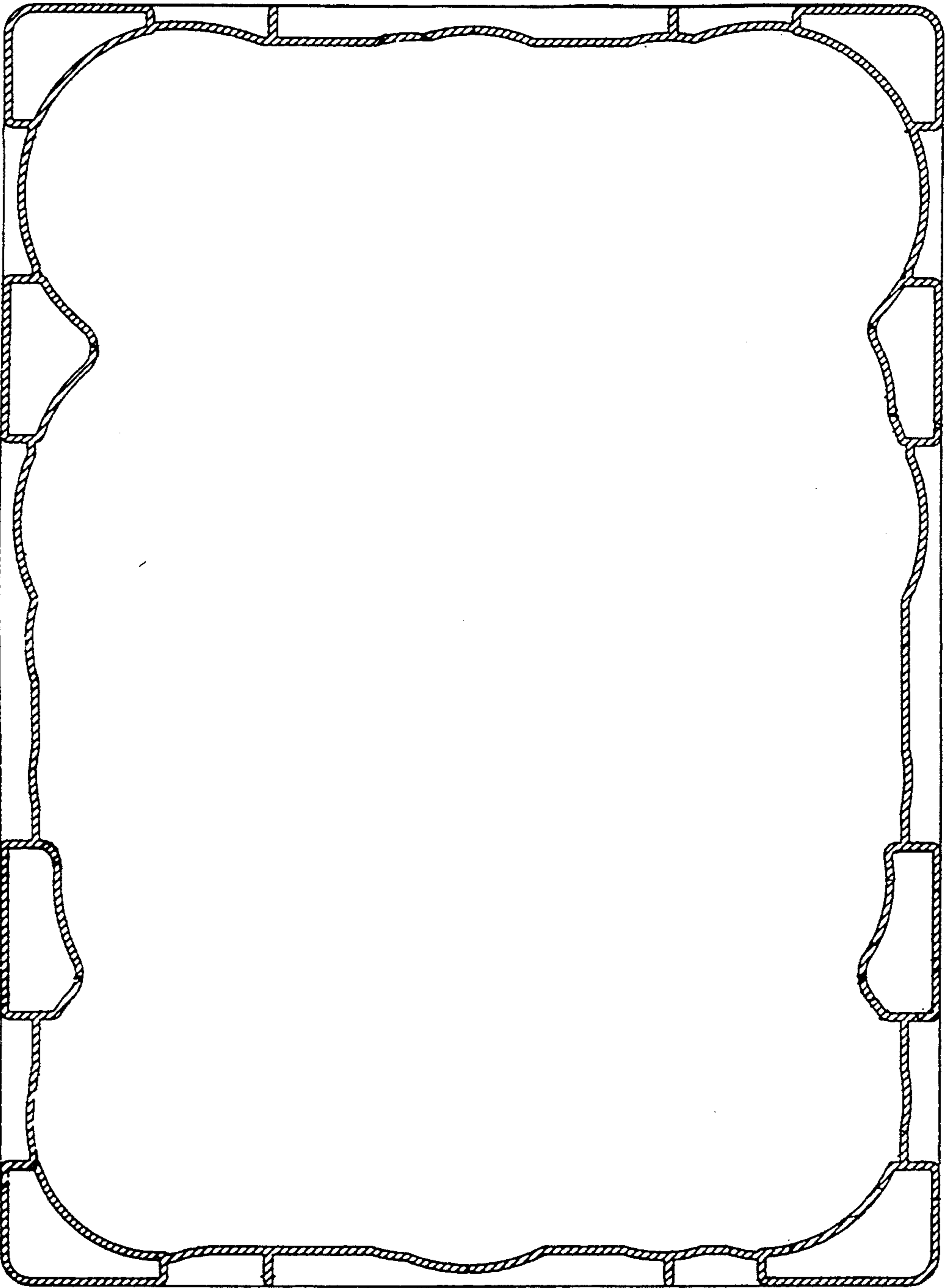

FIG. 10

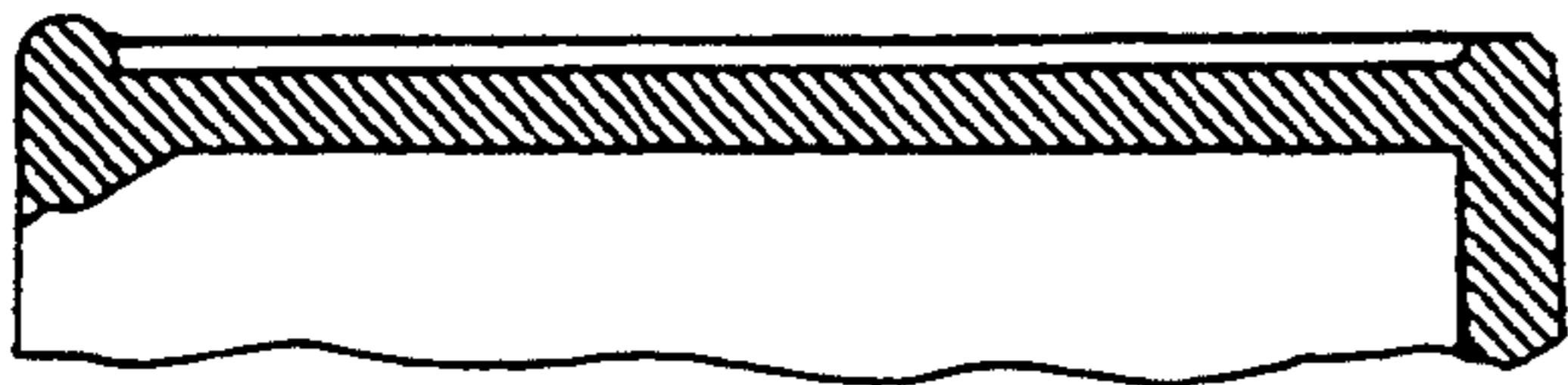

FIG. 11

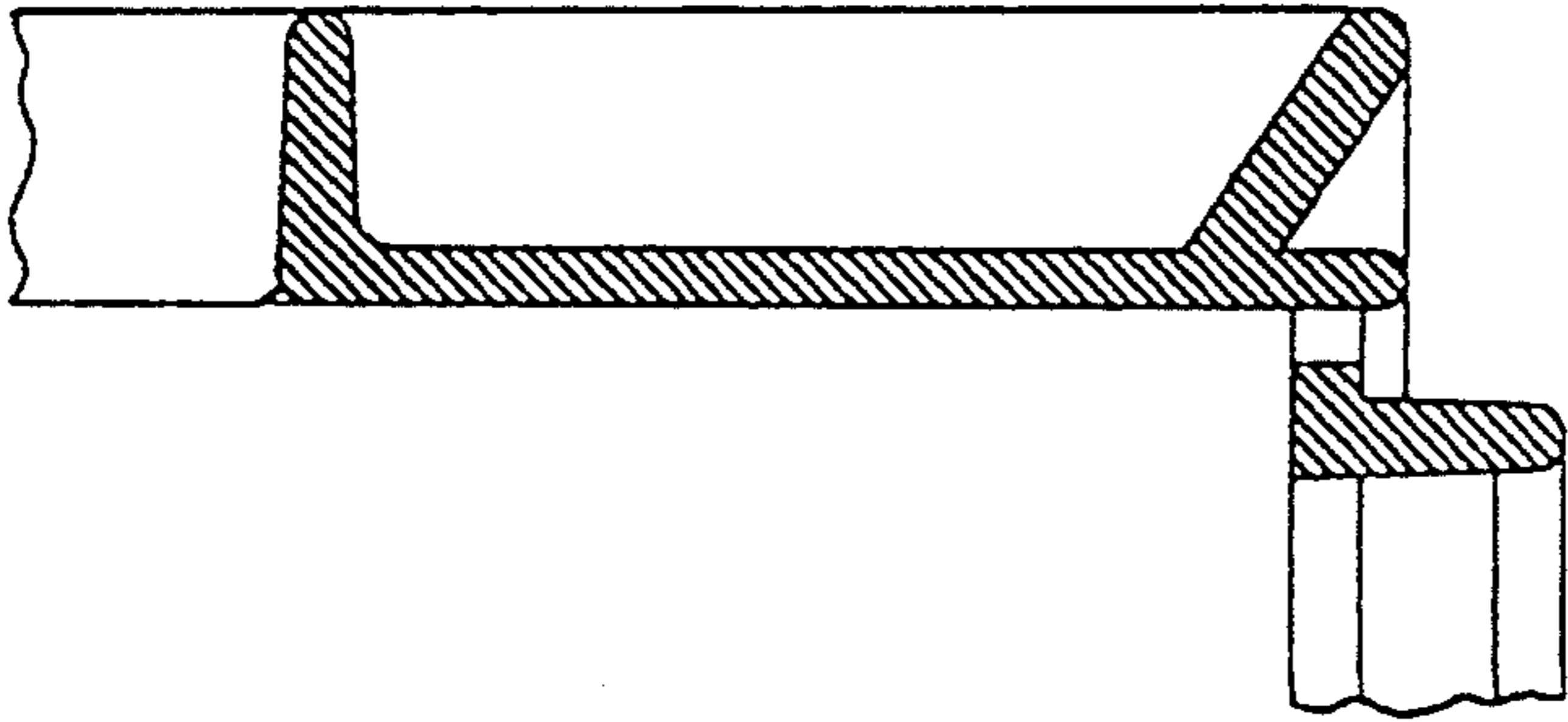

FIG. 12

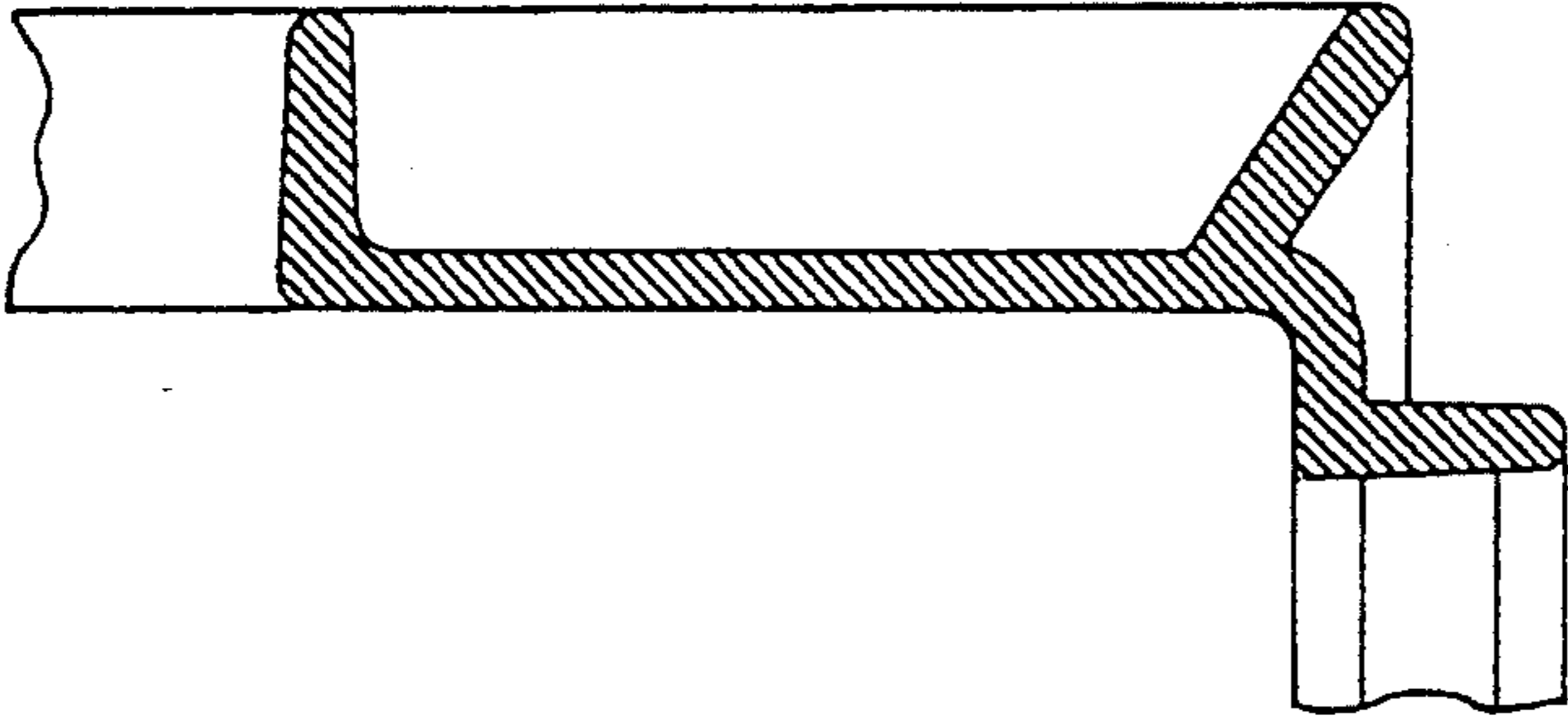

FIG. 14



FIG. 13

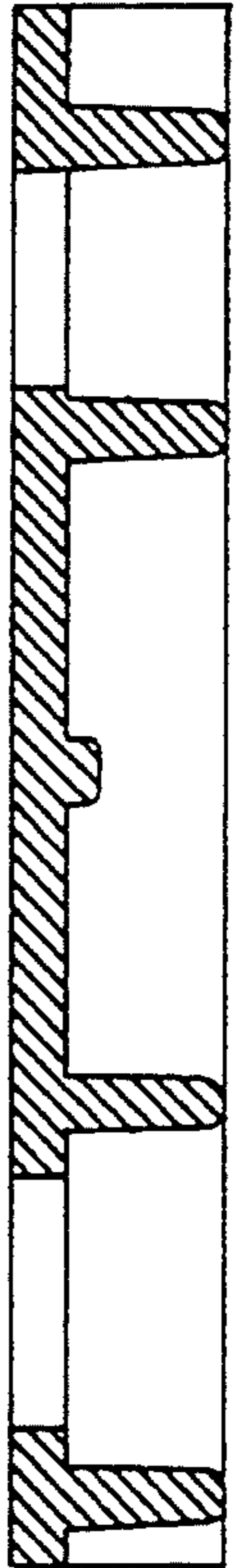

FIG. 15

