



US00D350409S

United States Patent [19]

[11] Patent Number: **Des. 350,409**

Johnson et al.

[45] Date of Patent: **** Sep. 6, 1994**

[54] **LIGHTING FIXTURE MOUNTABLE ON AN OVERHEAD SUPPORT**

[75] Inventors: **Dennis E. Johnson**, Grafton; **Scott P. Malmsten**, West Bend, both of Wis.

[73] Assignee: **SPI Lighting, Inc.**, Mequon, Wis.

[**] Term: **14 Years**

[21] Appl. No.: **18,984**

[22] Filed: **Feb. 18, 1994**

Home Lighting & Accessories, Jan. 1990, p. 13, Artcraft Ceiling Fixture.

Multiworld Lighting, Lamp Catalog, 1989, Ceiling Lamp Ellepi, #LS116.

Three pages of a 1991 ad by Lite Control for "Circa" fixtures.

Two pages of a 1988 ad by Peerless Lighting for "Pendant" fixtures.

A 1991 SPI Lighting as for "Renaissance" fixtures.

Primary Examiner—Susan J. Lucas

Attorney, Agent, or Firm—Quarles & Brady

[57] CLAIM

The ornamental design for a lighting fixture mountable on an overhead support, as shown and described.

Related U.S. Application Data

[62] Division of Ser. No. 468, Oct. 15, 1992.

[52] U.S. Cl. **D26/86; D26/84**

[58] Field of Search 362/147, 404-408; D26/72, 74, 80-92

DESCRIPTION

FIG. 1 is a perspective view taken from the bottom and front showing our new design;

FIG. 2 is a top plan view thereof;

FIG. 3 is a front elevational view thereof;

FIG. 4 is a bottom plan view thereof;

FIG. 5 is a perspective view taken from the bottom and front of a second embodiment thereof;

FIG. 6 is a top plan view of the embodiment of FIG. 5;

FIG. 7 is a front elevational view of the embodiment of FIG. 5; and,

FIG. 8 is a bottom plan view of the embodiment of FIG. 5.

The fragmentary broken line representation of a ceiling and a hanger in FIGS. 3 and 7 are for the purpose of illustration only and form no part of the claimed design.

[56] References Cited

U.S. PATENT DOCUMENTS

- D. 90,939 10/1933 Beck D26/88
- D. 303,437 9/1989 Mason D26/86
- D. 325,651 4/1992 Sonneman D26/74 X
- D. 329,921 9/1992 Benghozi .
- D. 341,442 11/1993 Shapiro D26/74 X

OTHER PUBLICATIONS

Abitare, Dec. 1985, Inside Back Cover, Ceiling Lighting Fixture.

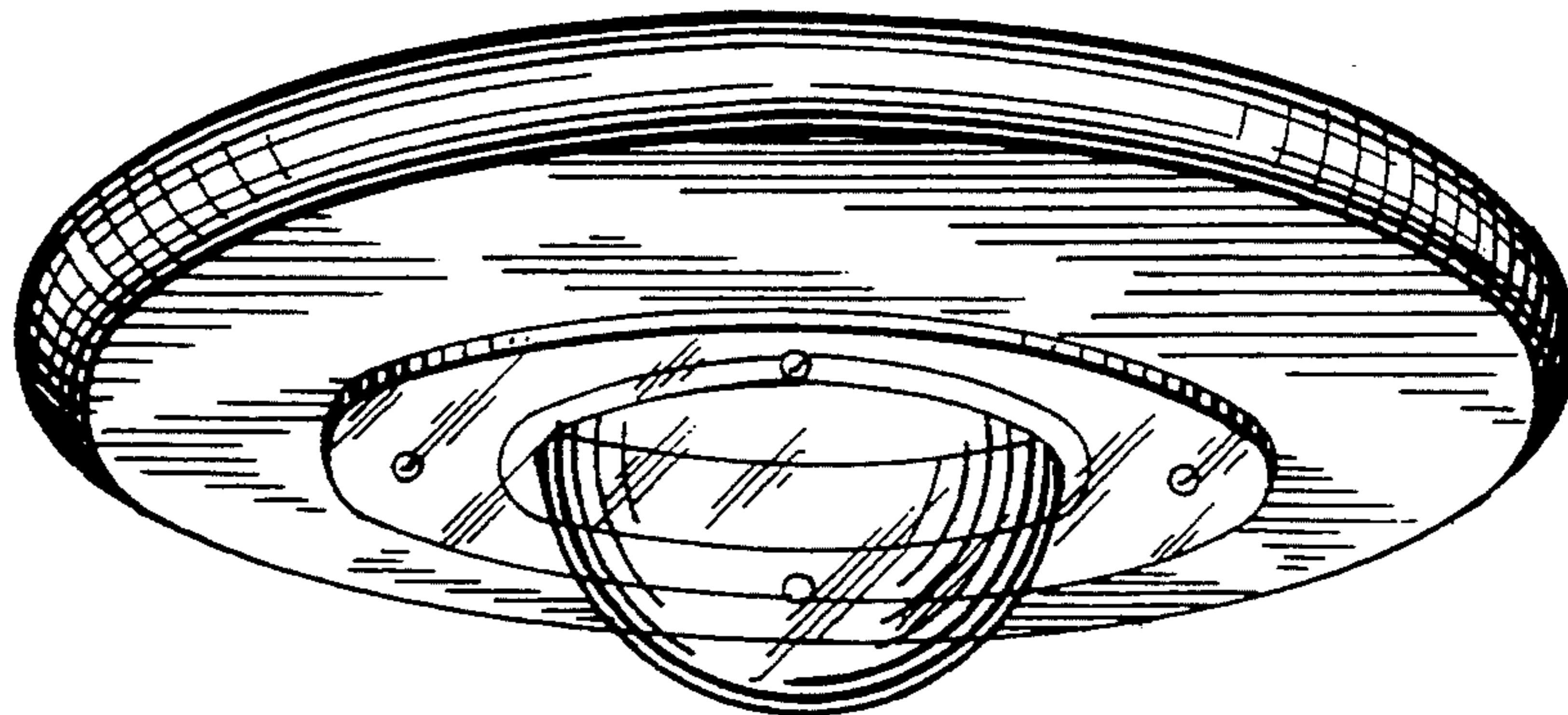
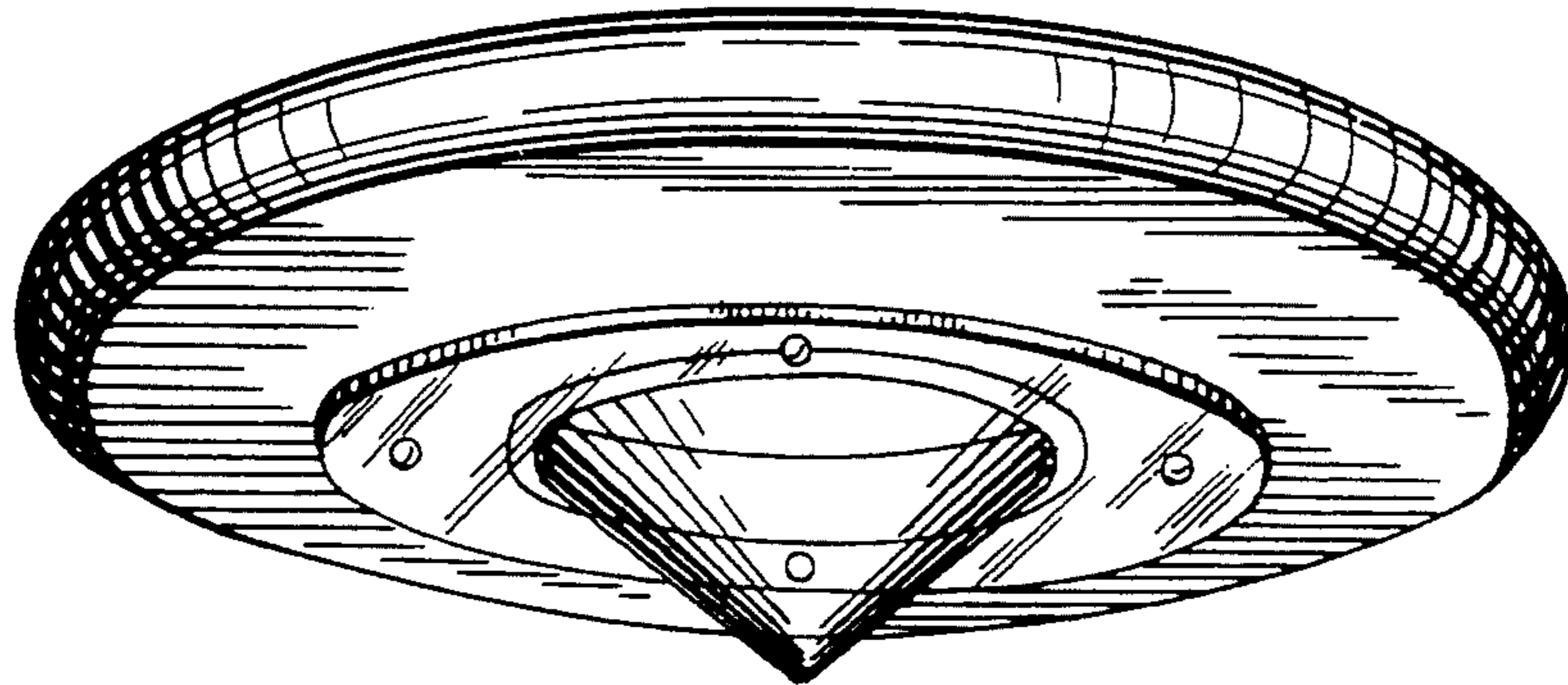

FIG. 1

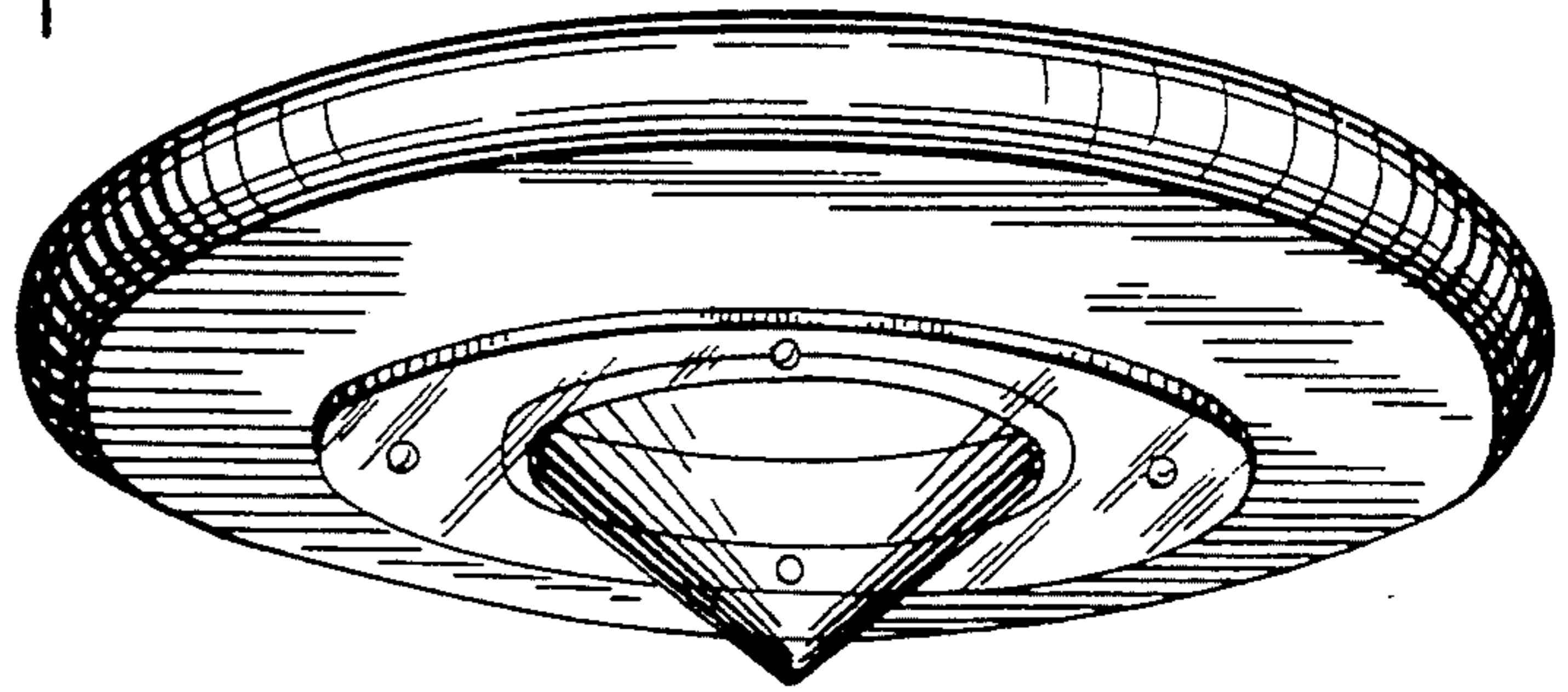

FIG. 2

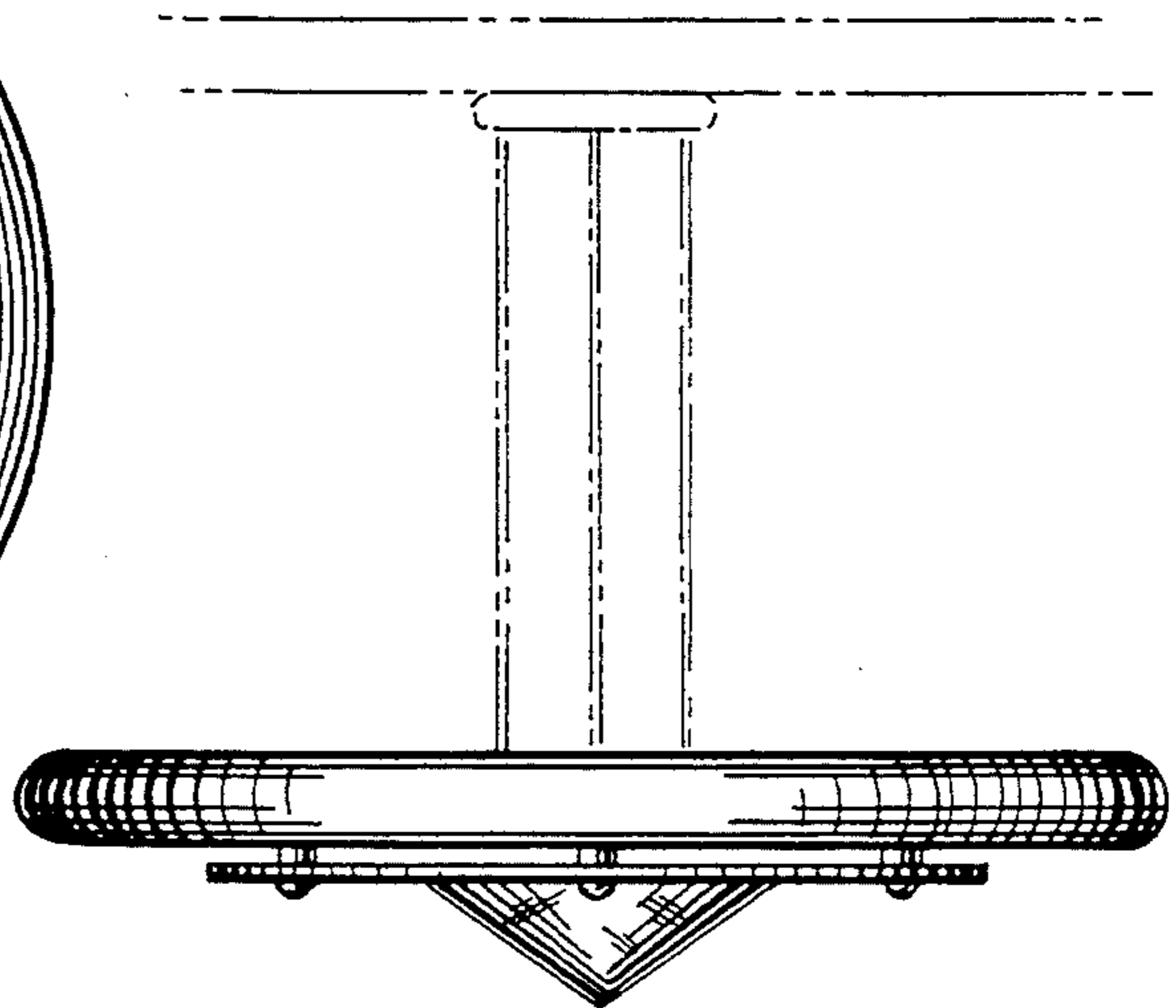
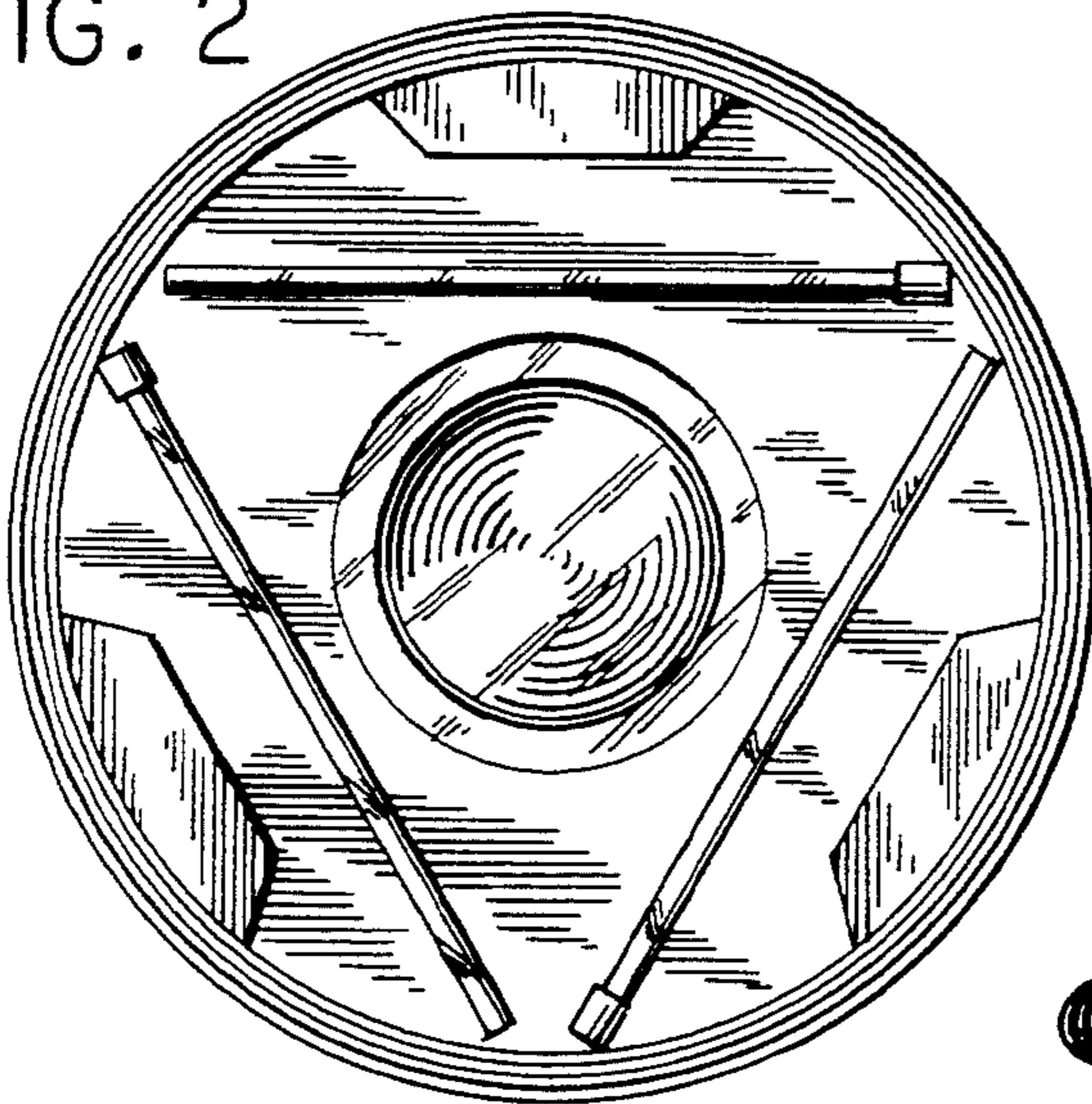

FIG. 3

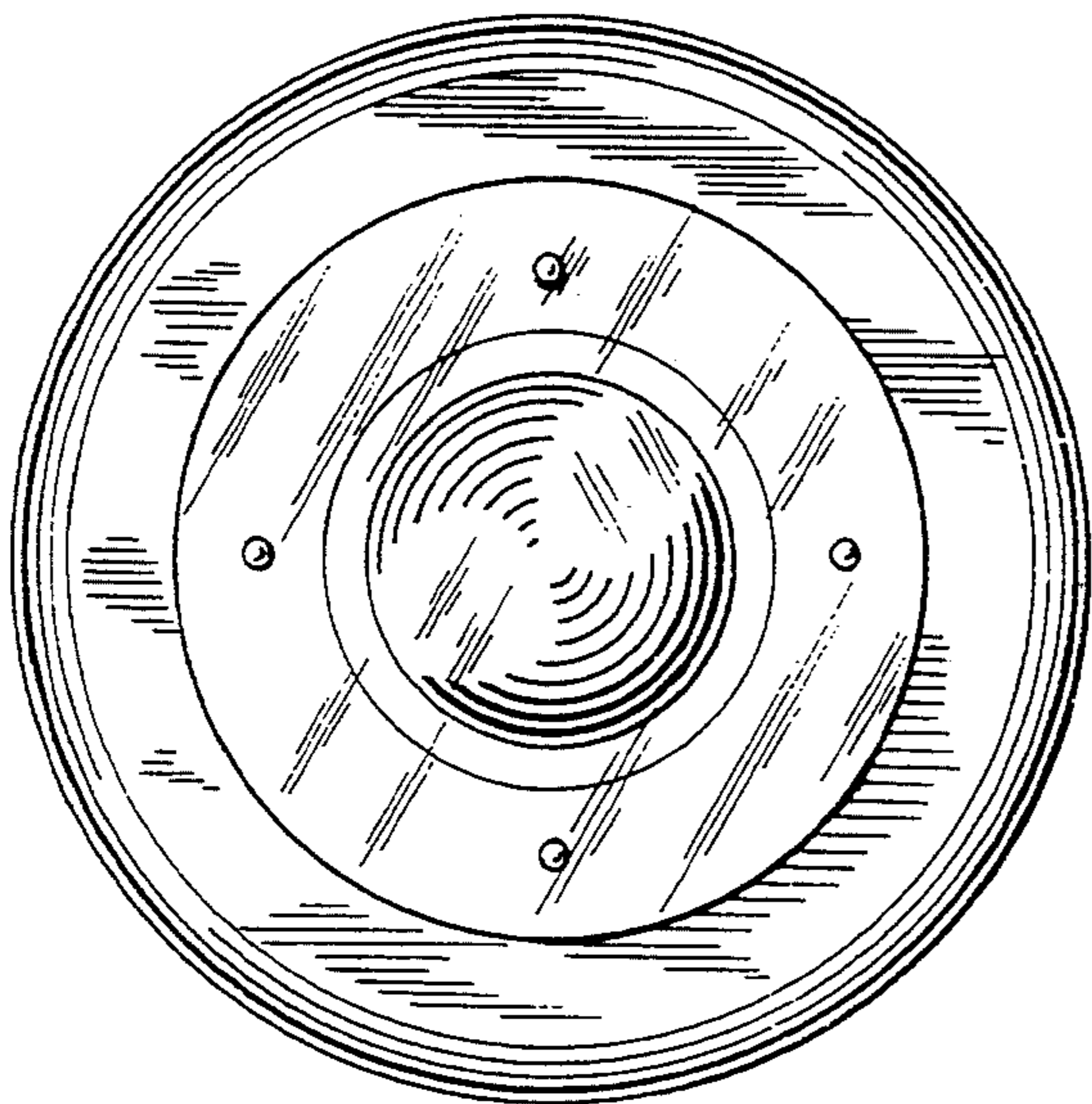

FIG. 4

FIG. 5

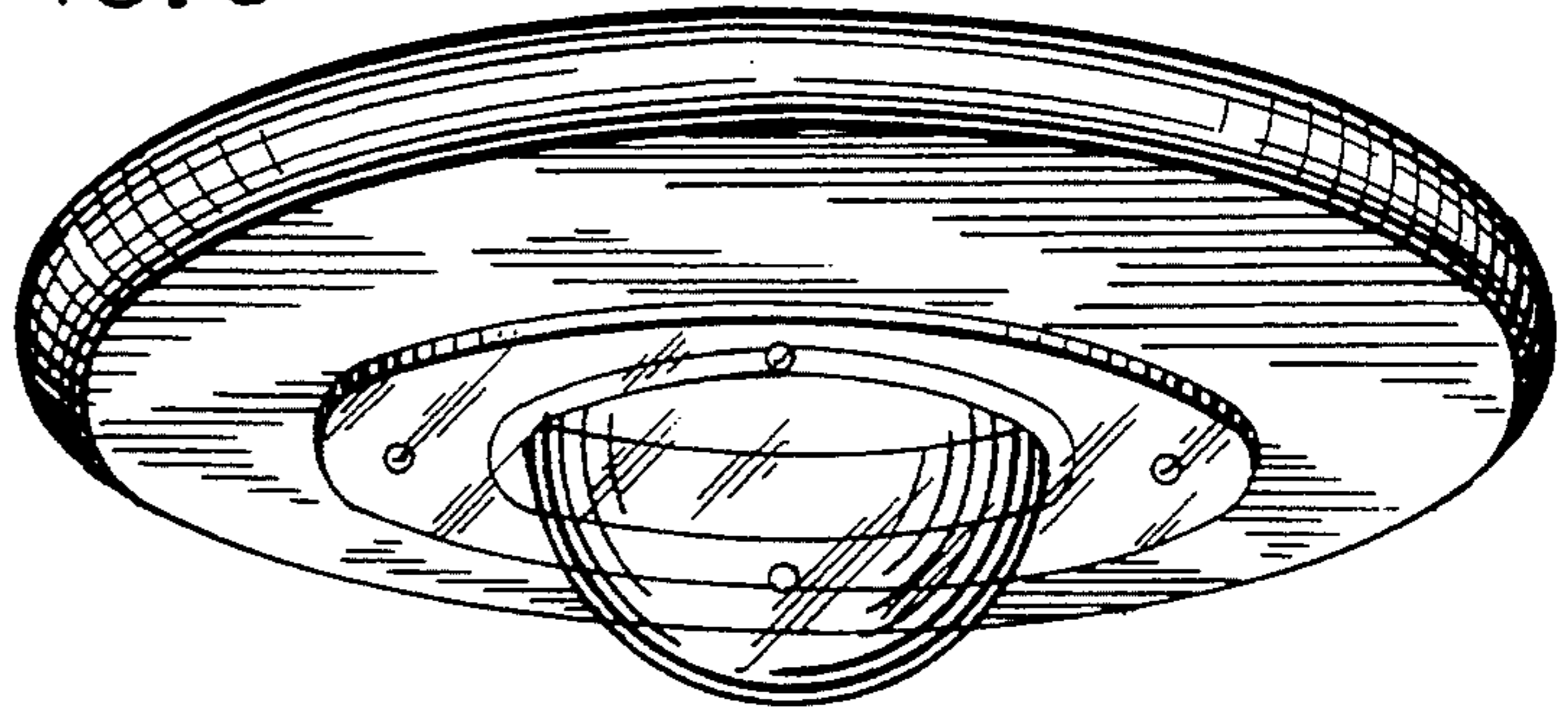

FIG. 6

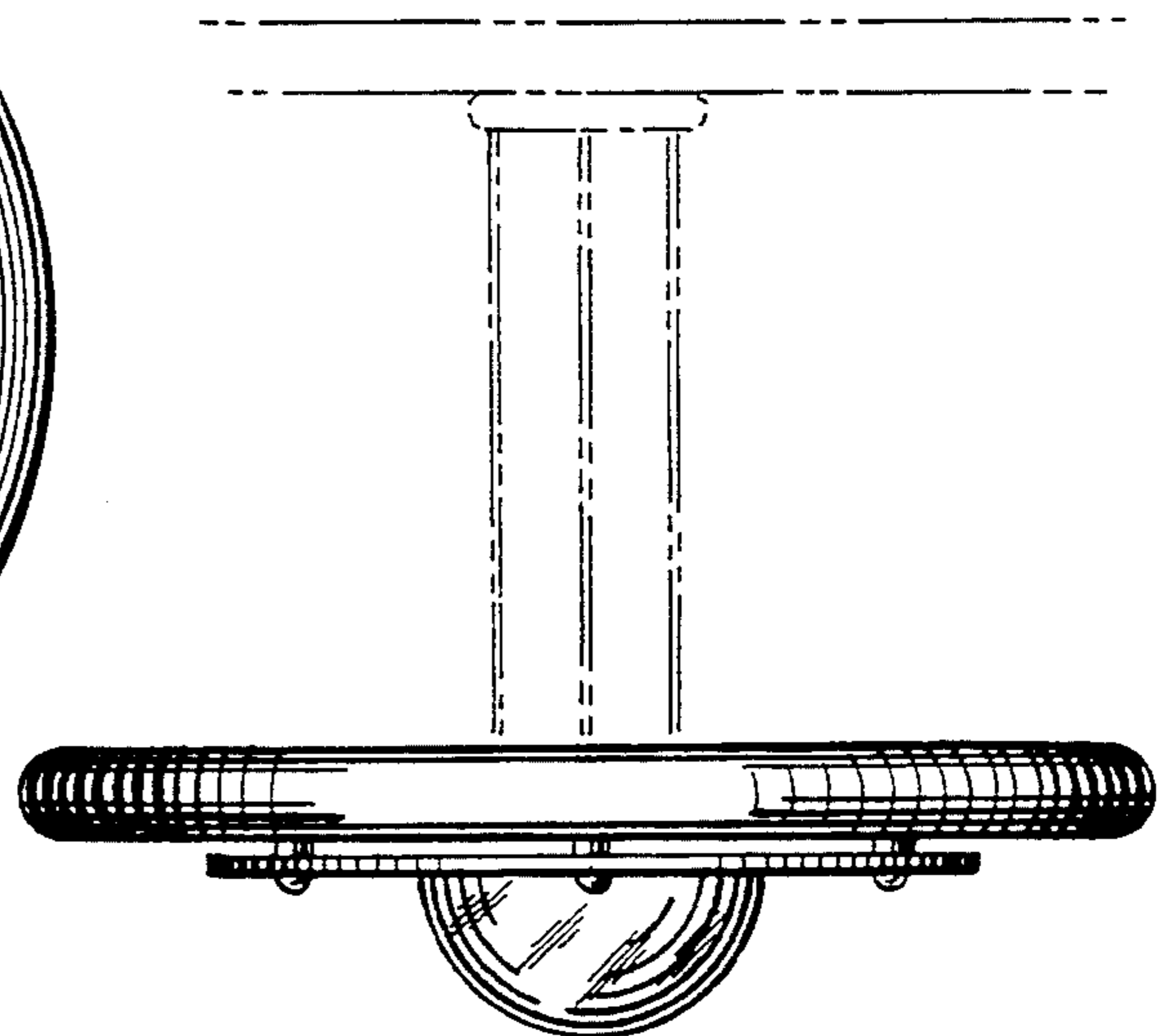
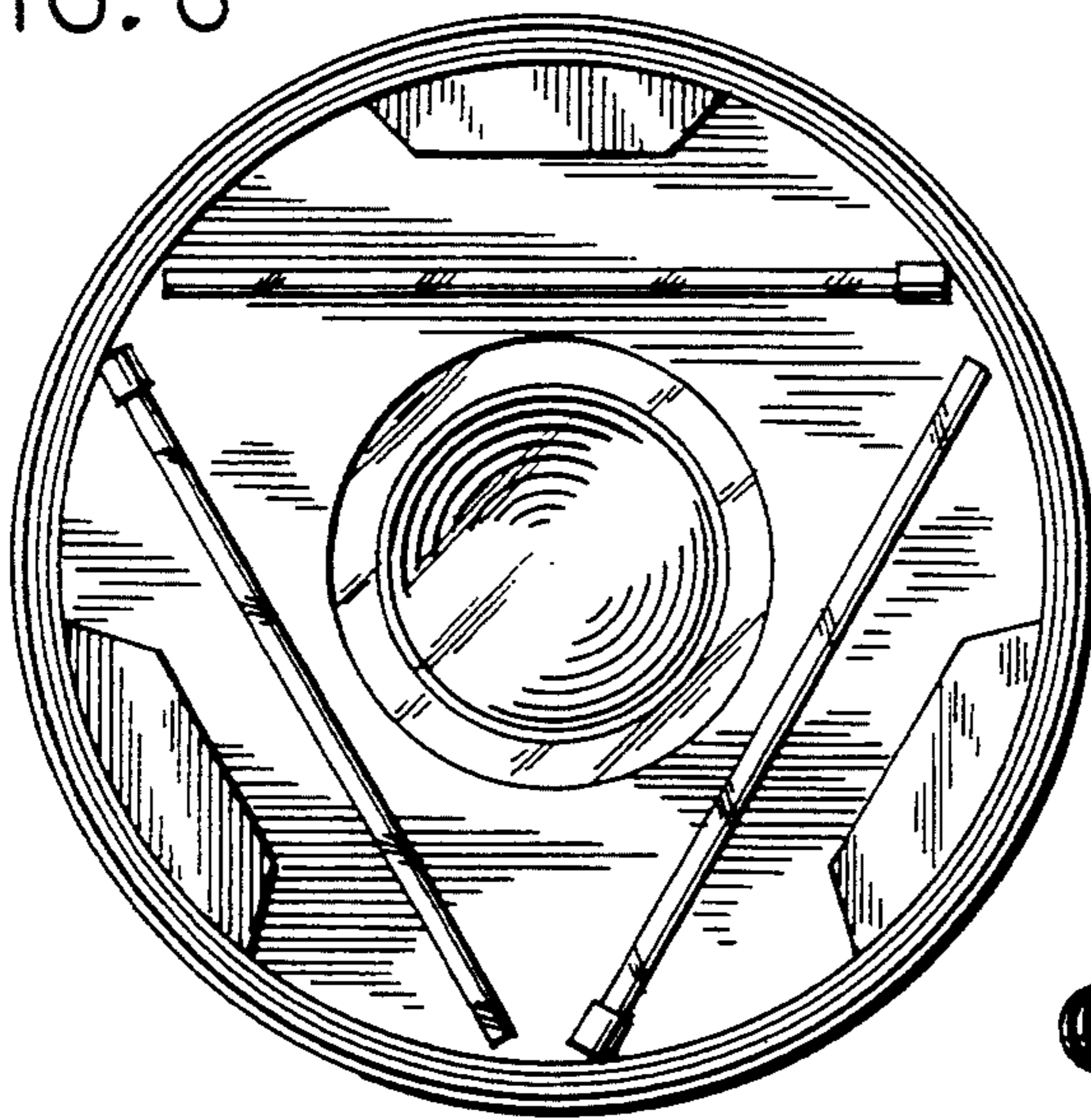

FIG. 7

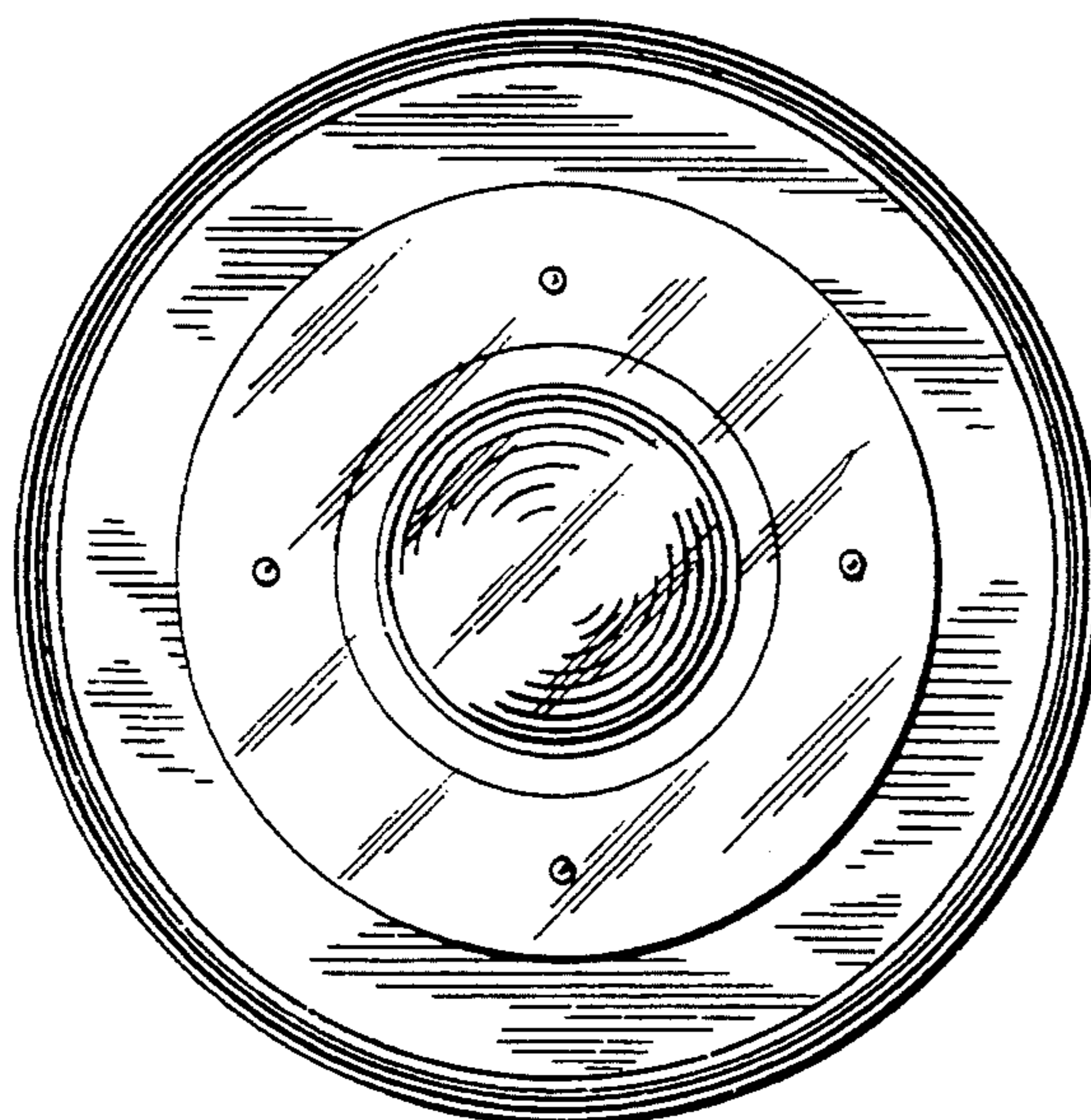

FIG. 8