



US00D350283S

United States Patent [19]

[11] Patent Number: **Des. 350,283**

Lenterman

[45] Date of Patent: **** Sep. 6, 1994**

[54] CAR COVER BOX

4,807,802 2/1989 Williams 229/8 X

[75] Inventor: **Henri Lenterman**, Culver City, Calif.

OTHER PUBLICATIONS

[73] Assignee: **Intromarketing, Inc.**, Woodland Hill, Calif.

Avon; Campaign 16, 1973; p. 48; "Straight Eight", Jaguar Car Decanter, Dune Buggy, and Maxwell '23.

[**] Term: **14 Years**

Primary Examiner—Barnard Ansher

Assistant Examiner—M. Siegel

Attorney, Agent, or Firm—John S. Christopher

[21] Appl. No.: **8,840**

[22] Filed: **May 28, 1993**

[57] CLAIM

[52] U.S. Cl. **D9/308; D21/78**

The ornamental design for a car cover box, as shown and described.

[58] Field of Search D9/308, 418, 414, 432; 229/8; 446/470; 206/457; D21/76, 78

DESCRIPTION

[56] References Cited

U.S. PATENT DOCUMENTS

D. 201,462	6/1965	Klein	D9/308	X
D. 214,262	5/1969	Paige	D9/308	
D. 256,670	9/1980	Fish	D9/308	
2,665,522	1/1954	Junod	446/470	
4,055,250	10/1977	Mayhew	229/8	X
4,646,959	3/1987	Sheffer	206/457	X

FIG. 1 is a perspective view of a car cover box showing my new design;

FIG. 2 is a front elevation thereof;

FIG. 3 is a right side elevation thereof; the left side elevation being a mirror image thereof;

FIG. 4 is a rear elevation thereof;

FIG. 5 is a top plan view thereof; and,

FIG. 6 is a bottom plan view thereof.

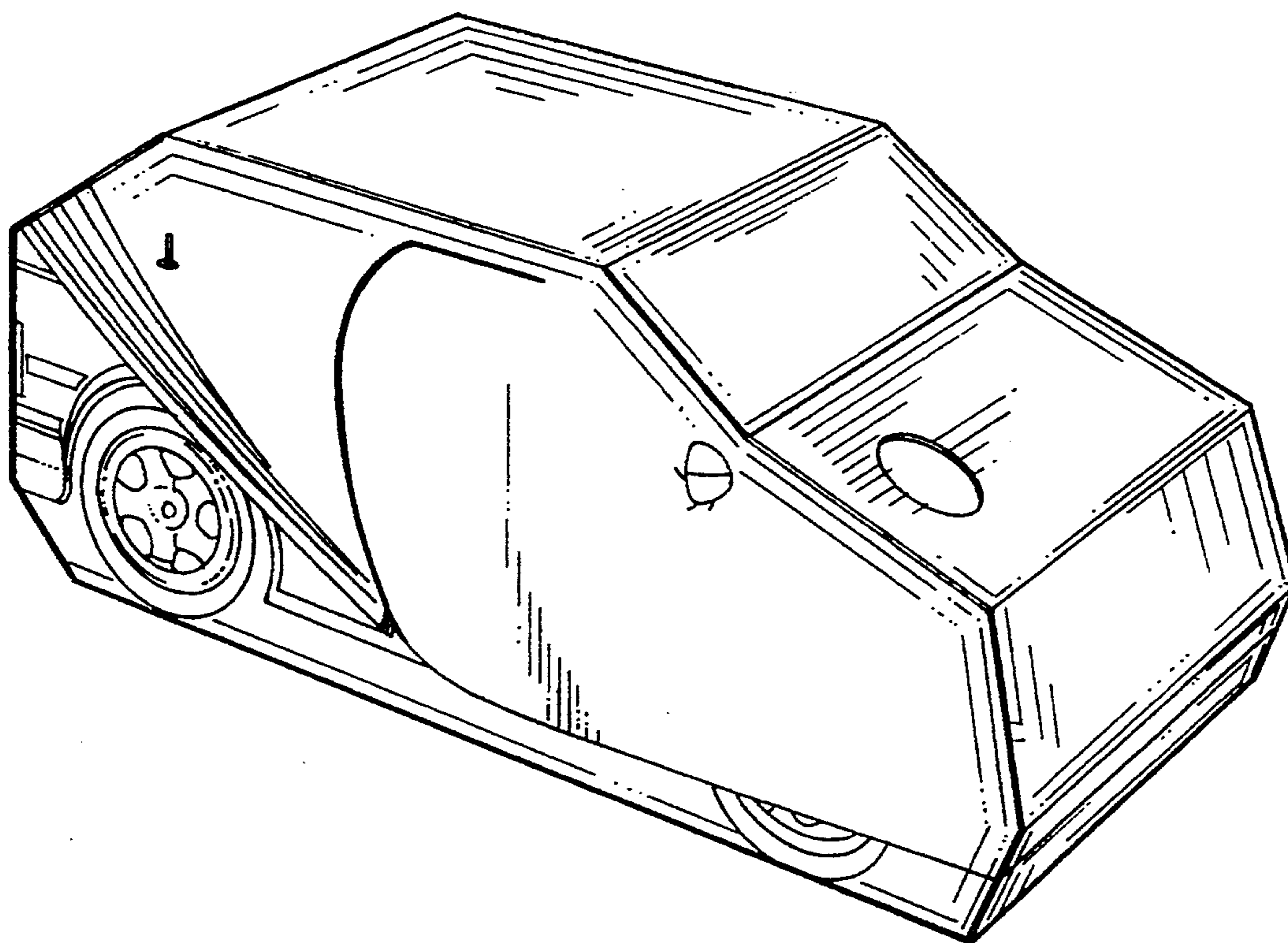

FIG. 1

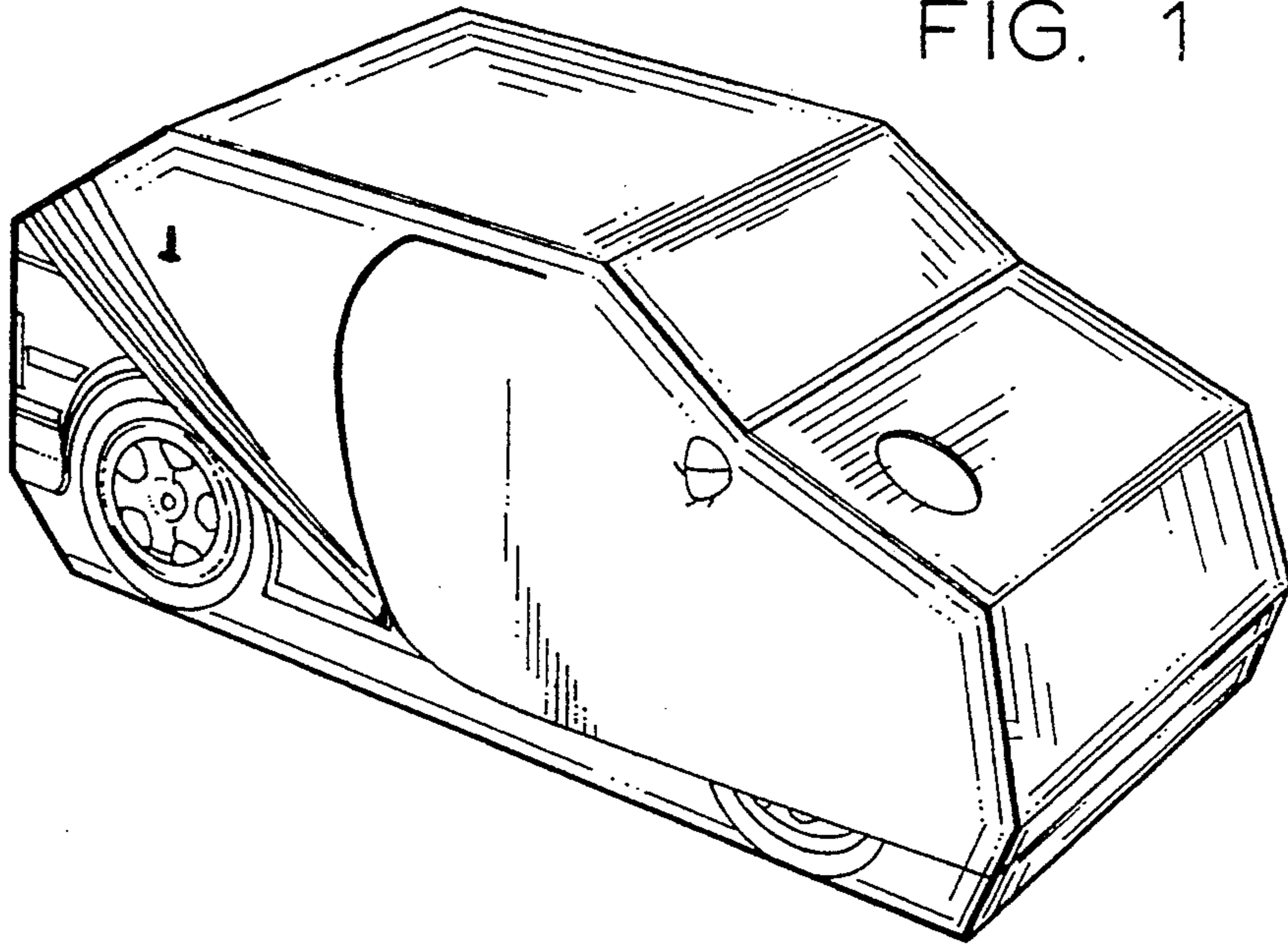

FIG. 2

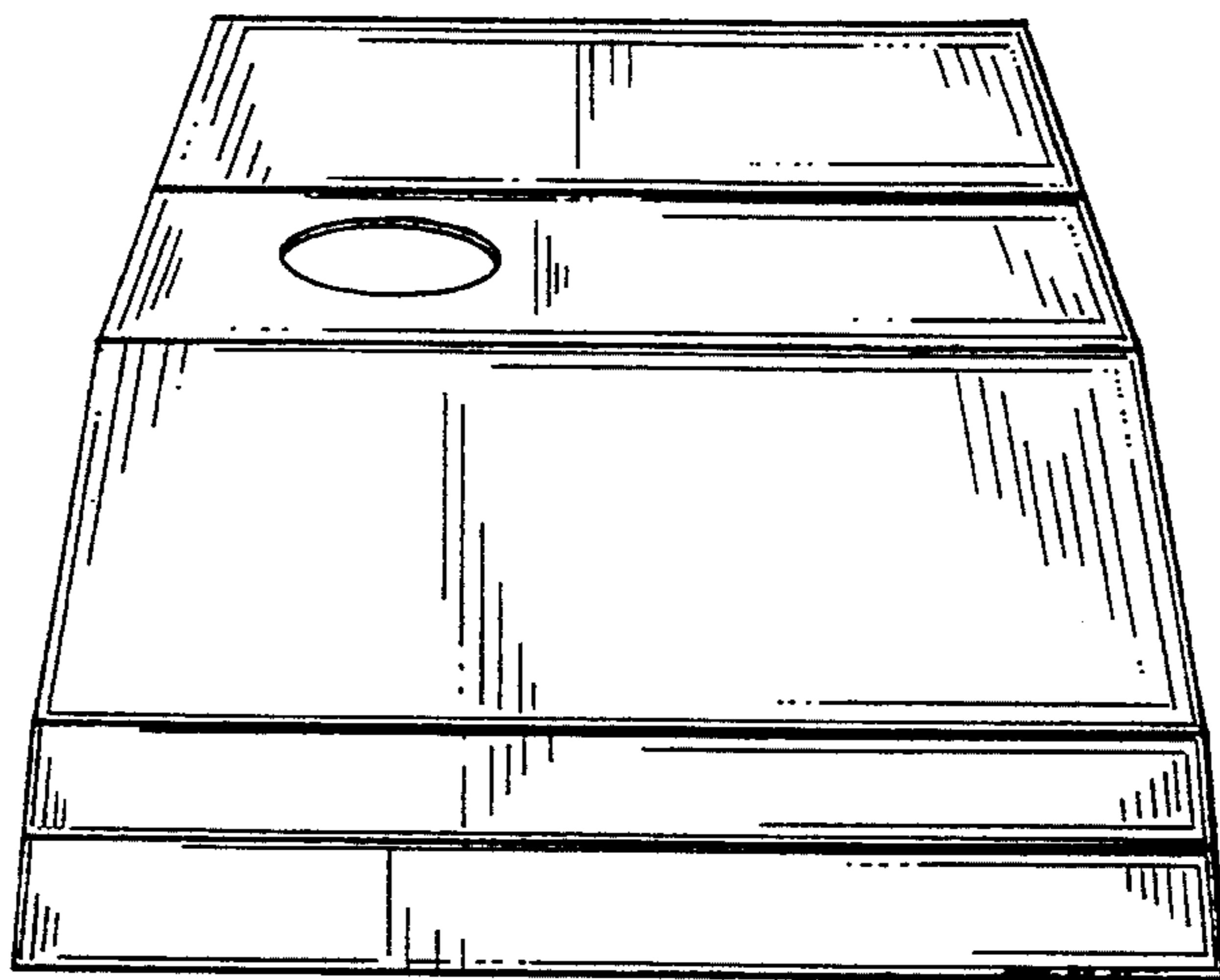

FIG. 3

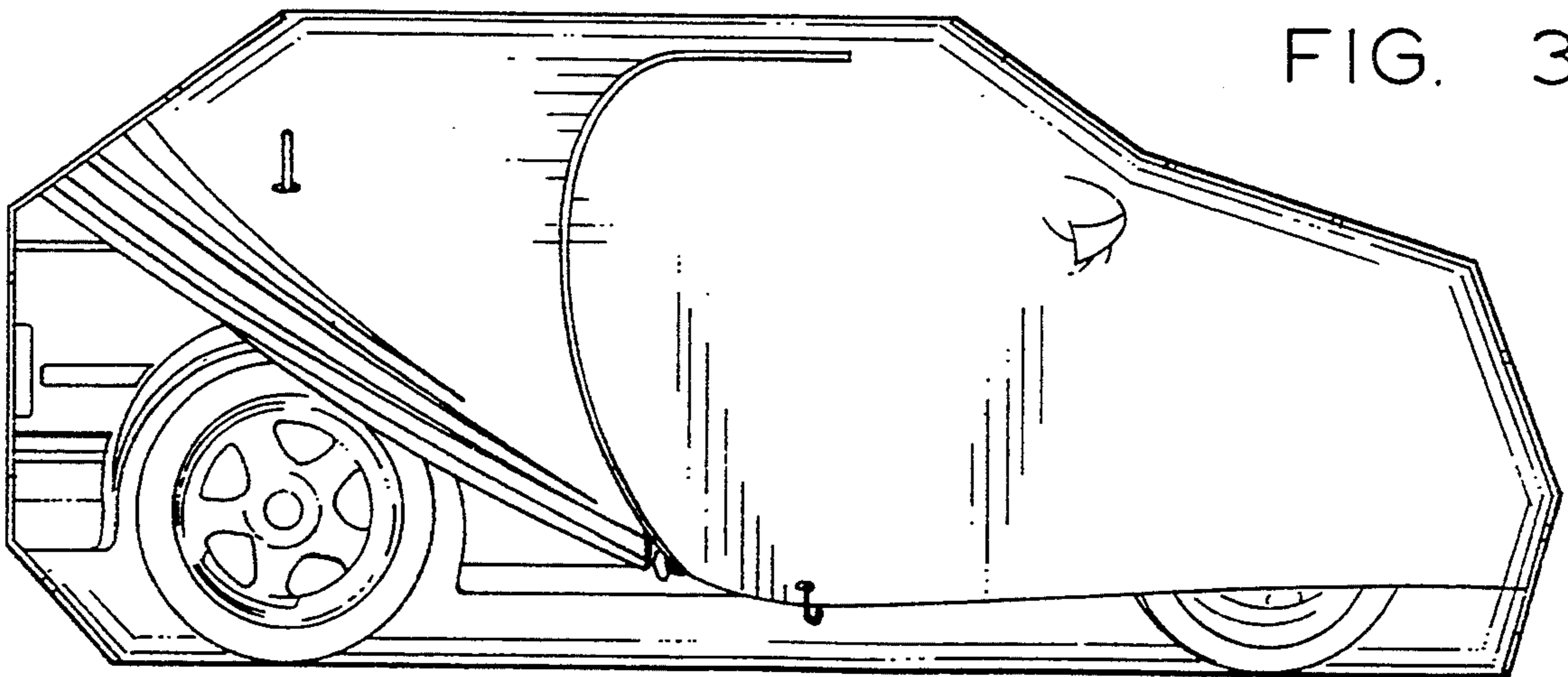

FIG. 4

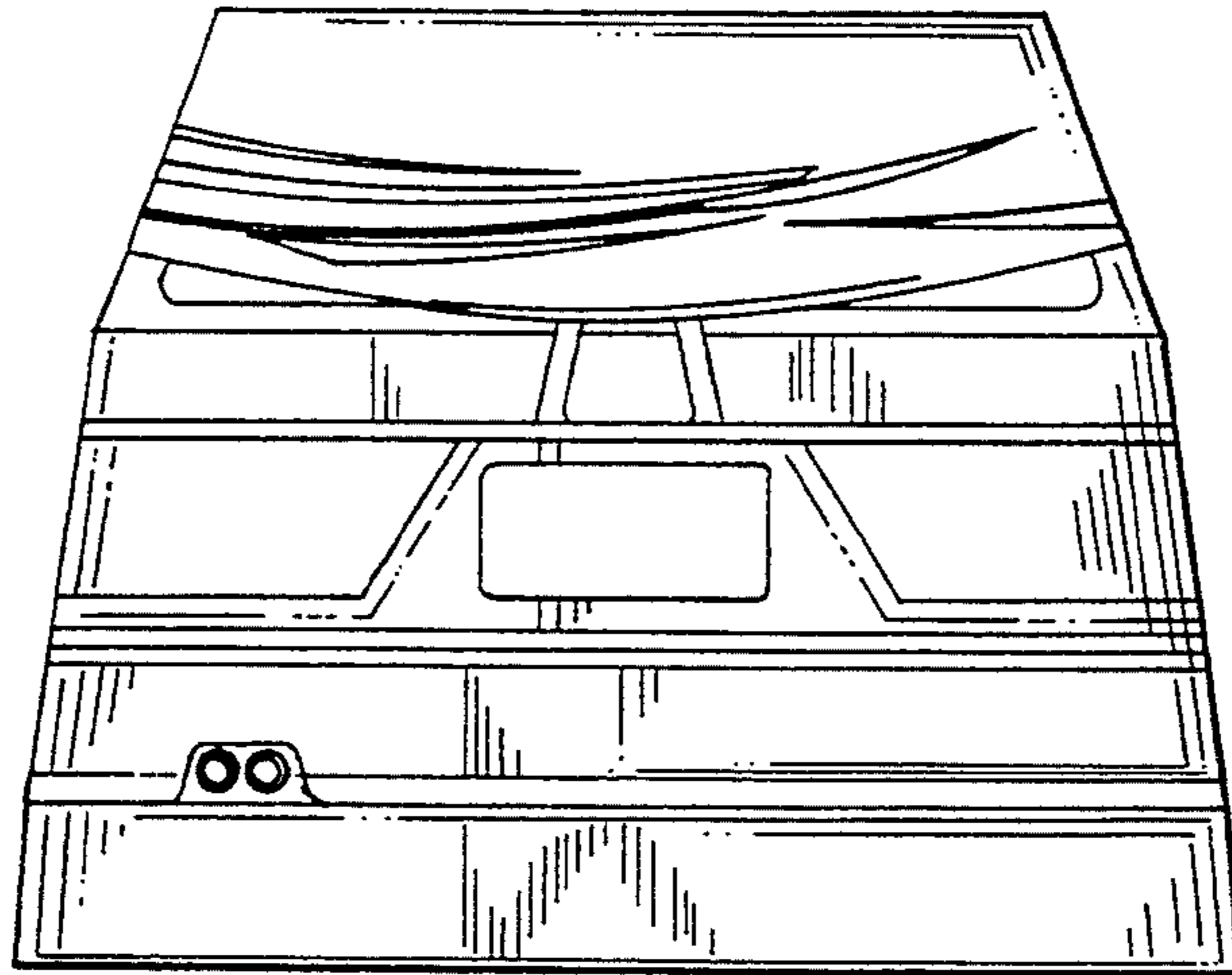

FIG. 5

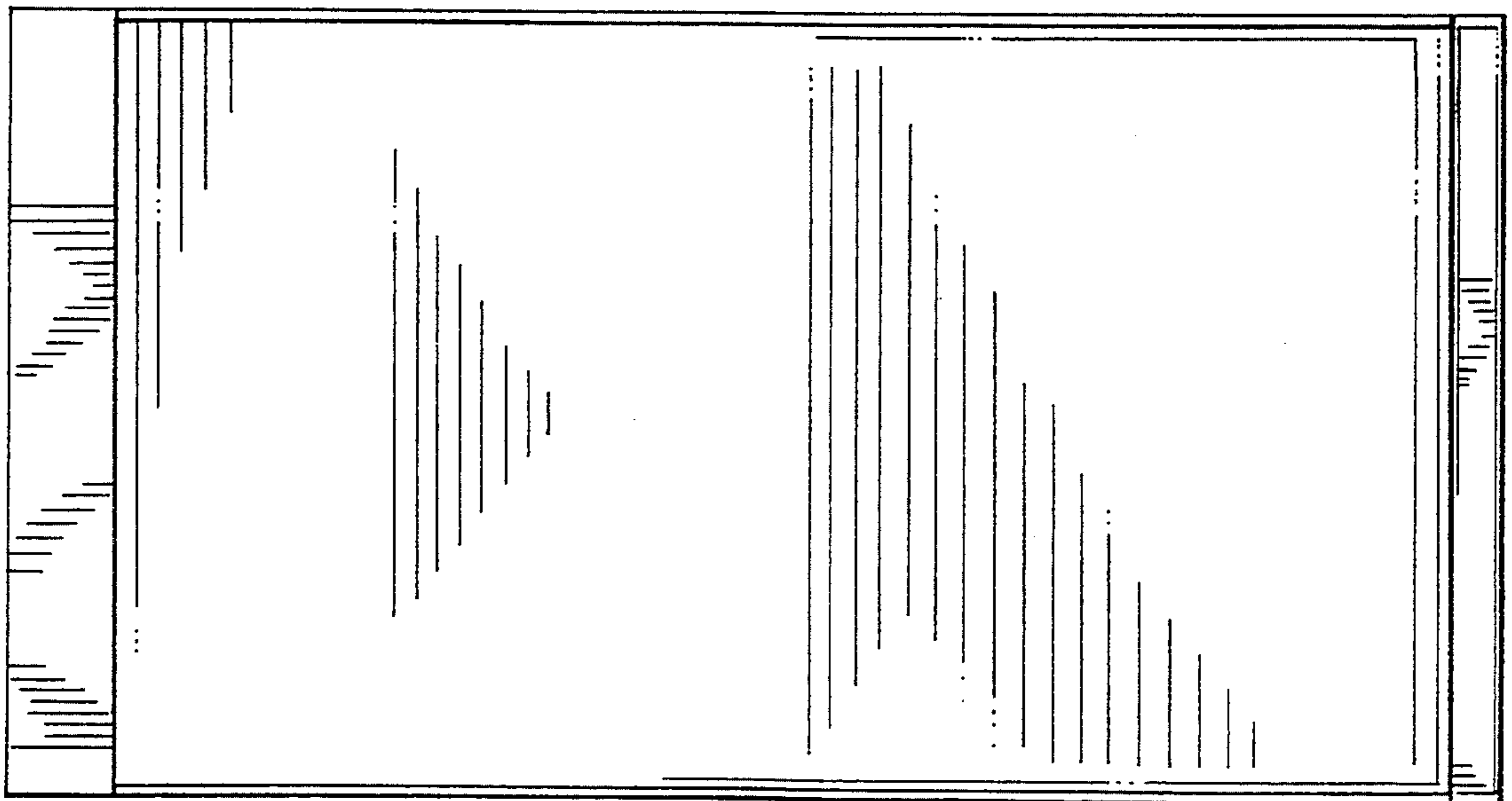
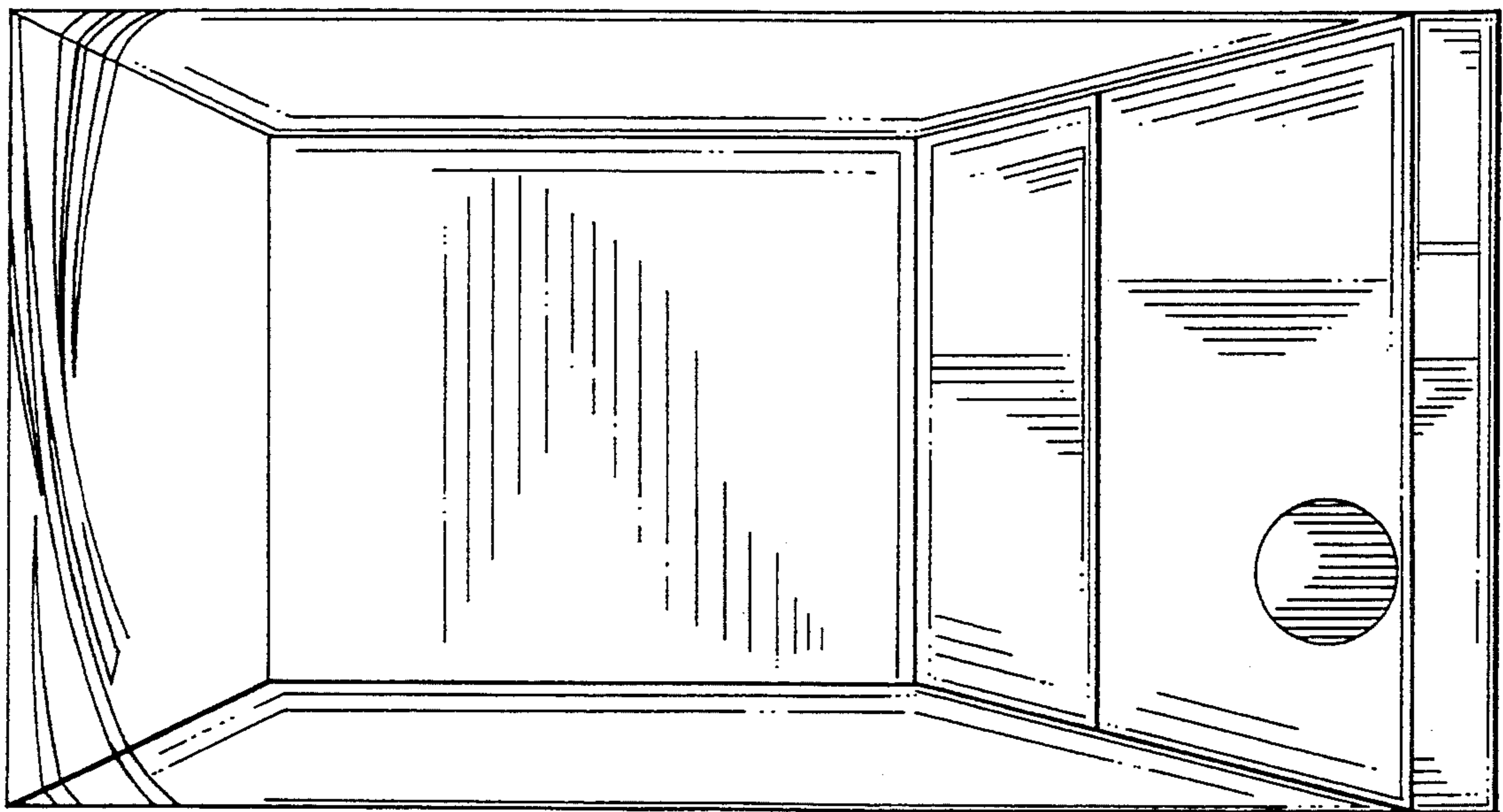

FIG. 6