



US00D350179S

United States Patent [19]

[11] Patent Number: **Des. 350,179**

Johnson

[45] Date of Patent: **** Aug. 30, 1994**

[54] **COMBINED GOLF BALL MARKER AND HOLDER**

[76] Inventor: **Jay M. Johnson, 5278 Magnolia Ave., Riverside, Calif. 92506**

[**] Term: **14 Years**

[21] Appl. No.: **16,237**

[22] Filed: **Dec. 10, 1993**

[52] U.S. Cl. **D21/234**

[58] Field of Search **273/162 D; D21/234**

[56] **References Cited**

U.S. PATENT DOCUMENTS

D. 224,657	8/1972	Fisher	D21/234
D. 306,874	3/1990	Lapin	D21/234 X
3,462,862	8/1969	Chase	224/918 X
5,282,616	2/1994	Stacavich-Notaro	273/32 A

Primary Examiner—Melvin B. Feifer
Assistant Examiner—Cheri Cohen
Attorney, Agent, or Firm—Gordon K. Anderson

[57] **CLAIM**

The ornamental design for a combined golf ball marker and holder, as shown and described.

DESCRIPTION

FIG. 1 is a perspective view of a combined golf ball marker and holder showing my new design;
FIG. 2 is an exploded perspective view thereof;
FIG. 3 is a plan view thereof;
FIG. 4 is a front elevation view thereof;
FIG. 5 is a side elevation view thereof;
FIG. 6 is a bottom plan view thereof;
FIG. 7 is a cross-sectional view taken along lines 7—7 of FIG. 2; and,
FIG. 8 is a cross-sectional view taken along lines 8—8 of FIG. 2.

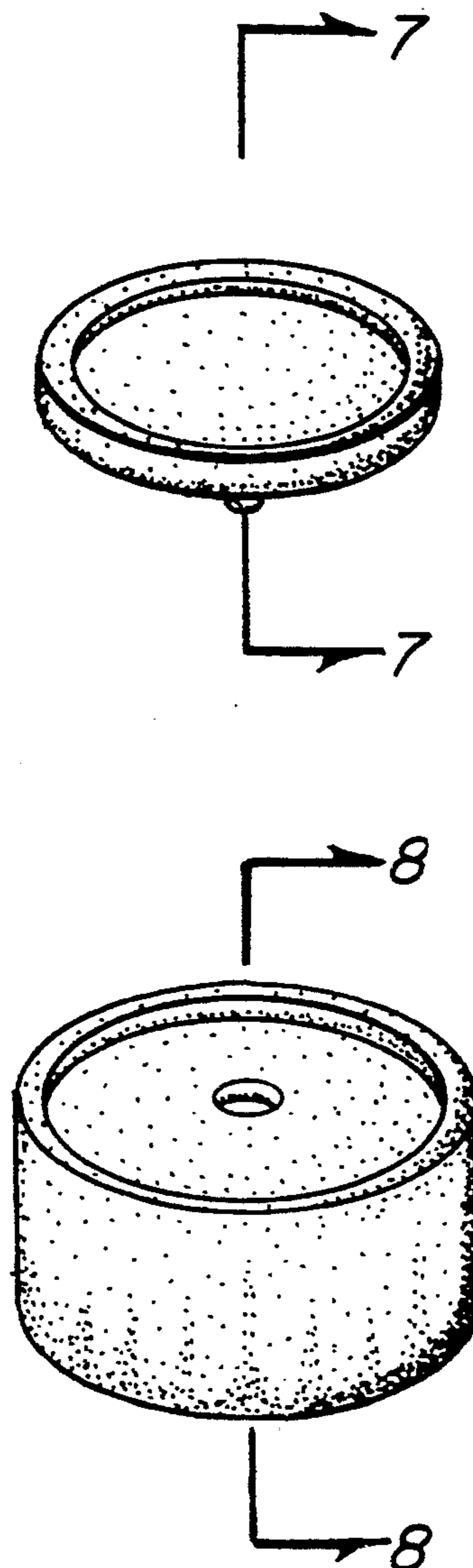

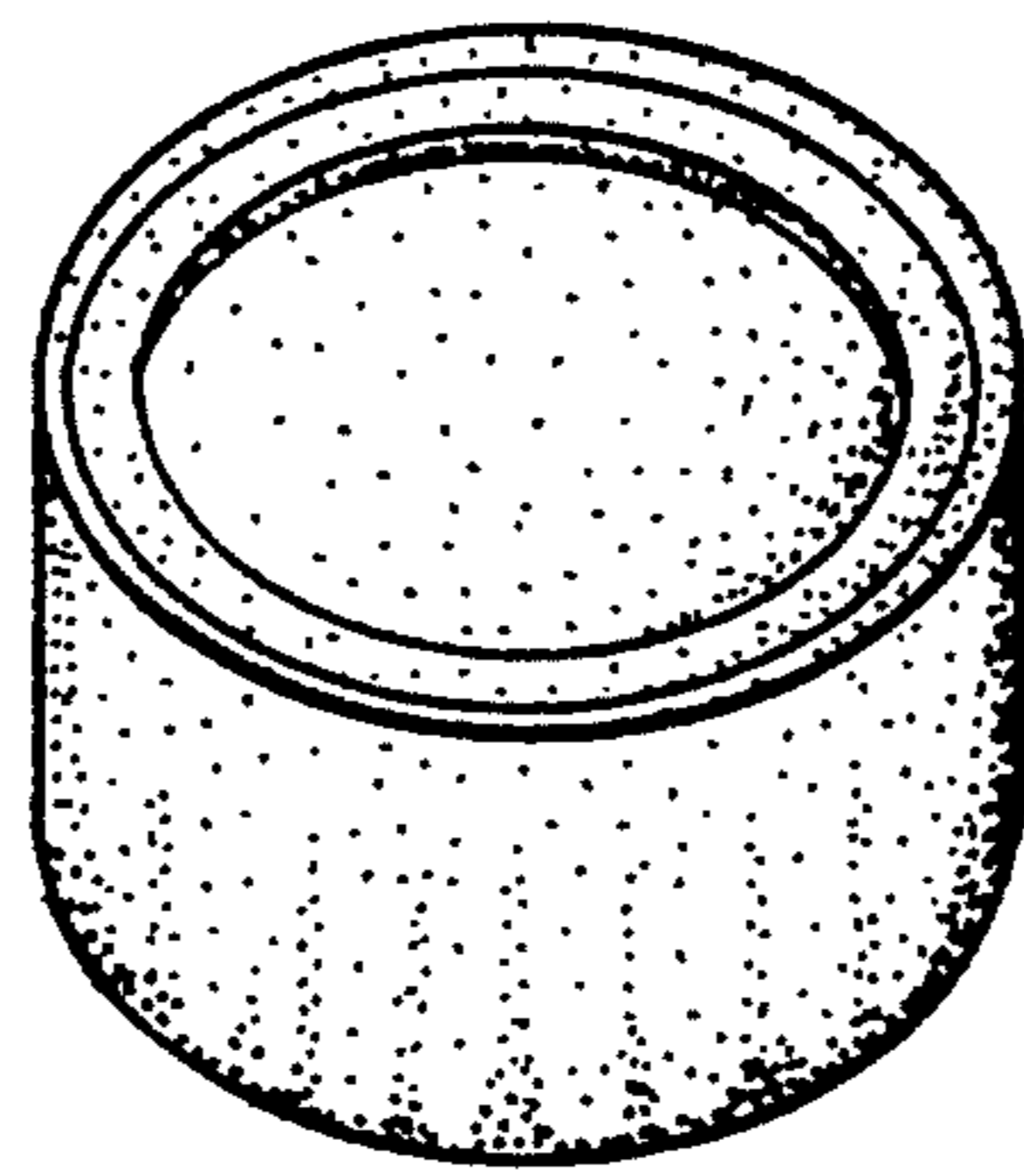

FIG. 1

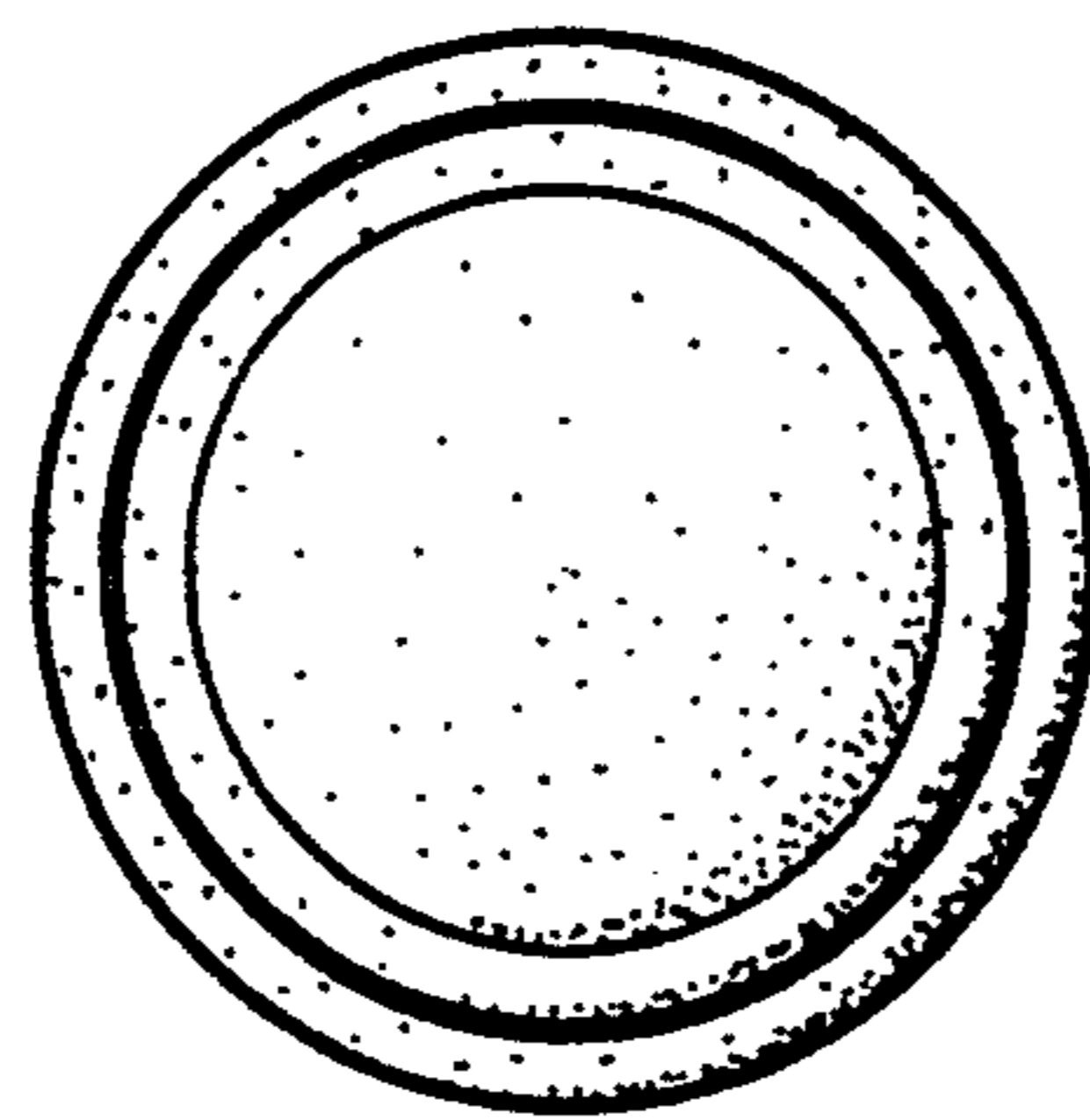

FIG. 3

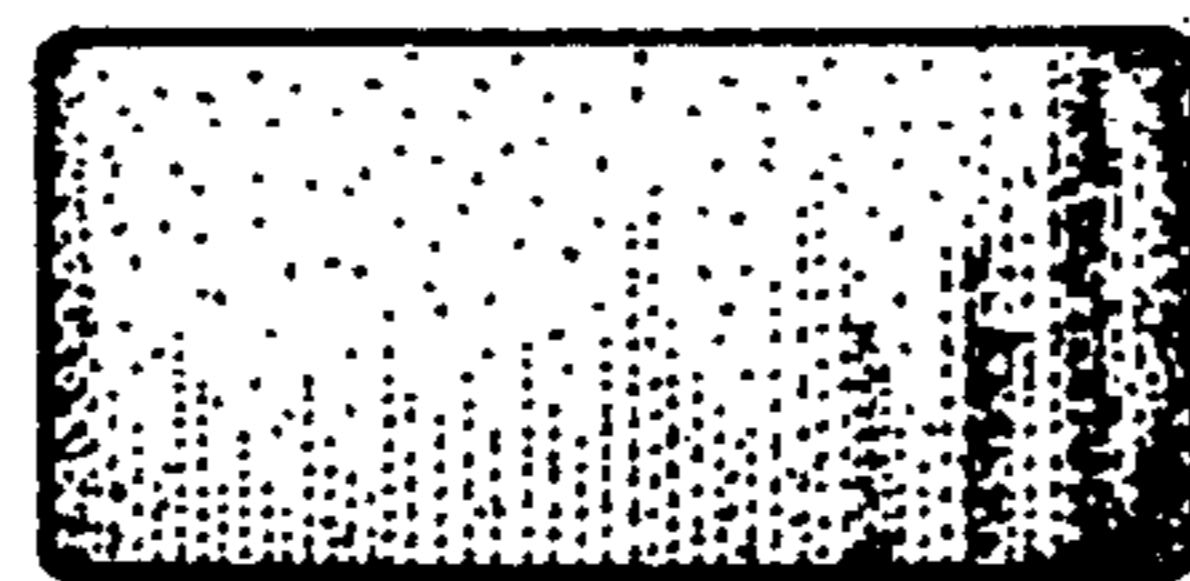

FIG. 4

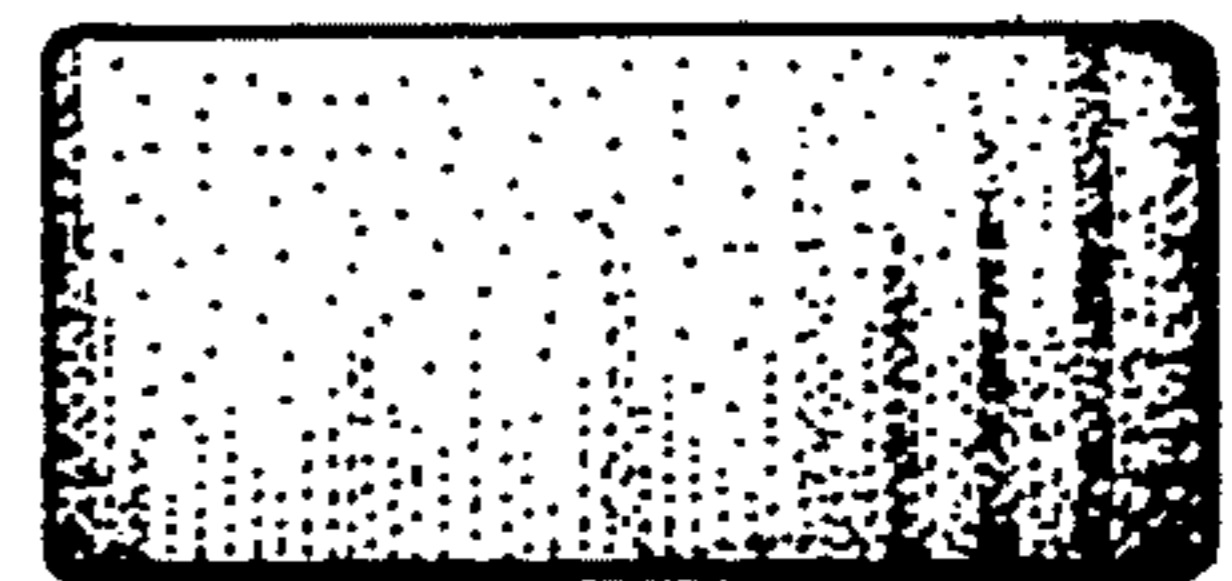

FIG. 5

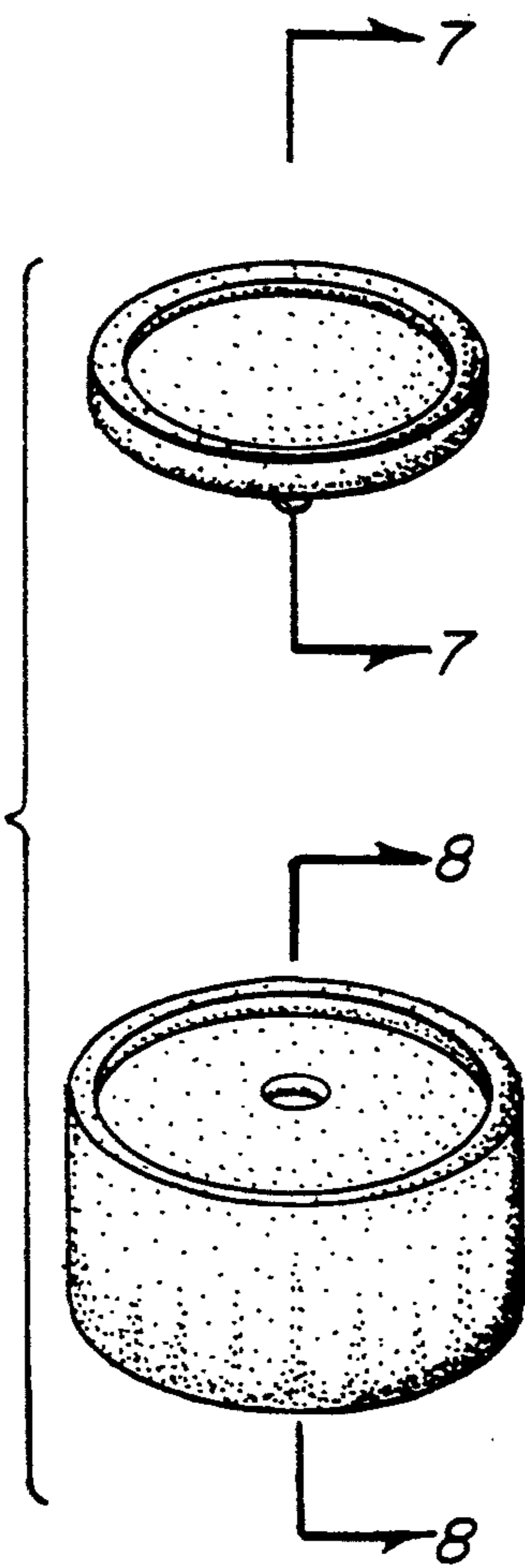

FIG. 2

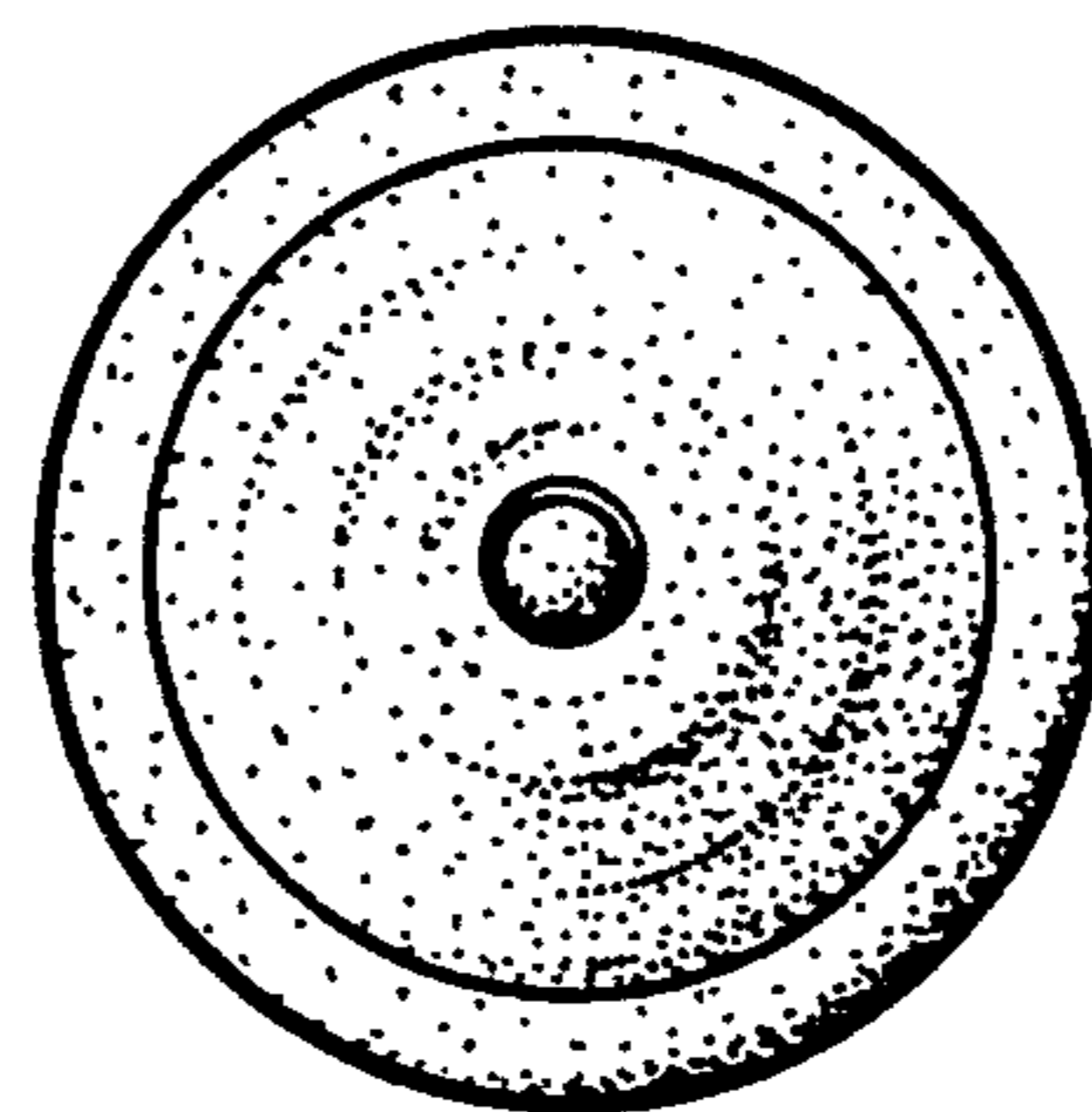

FIG. 6

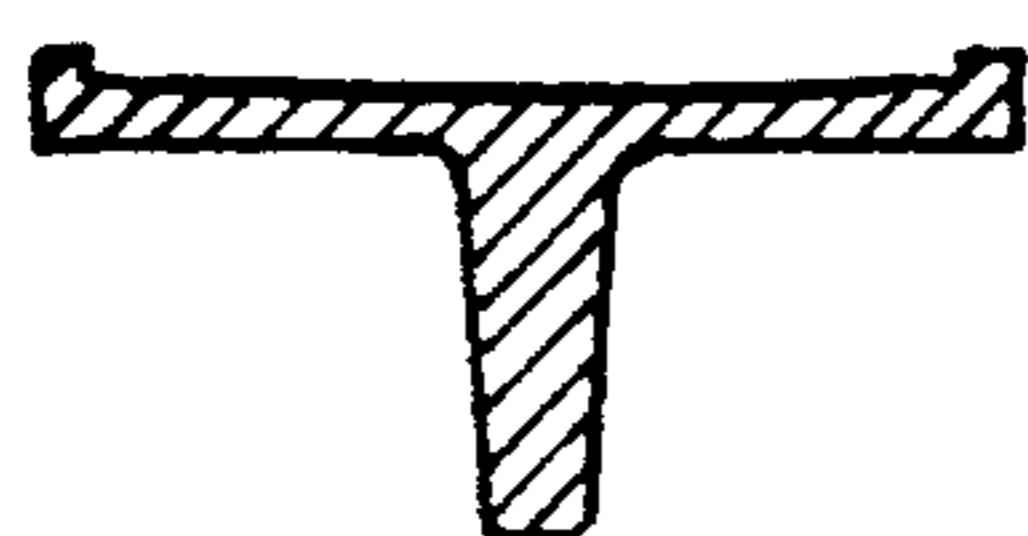

FIG. 7

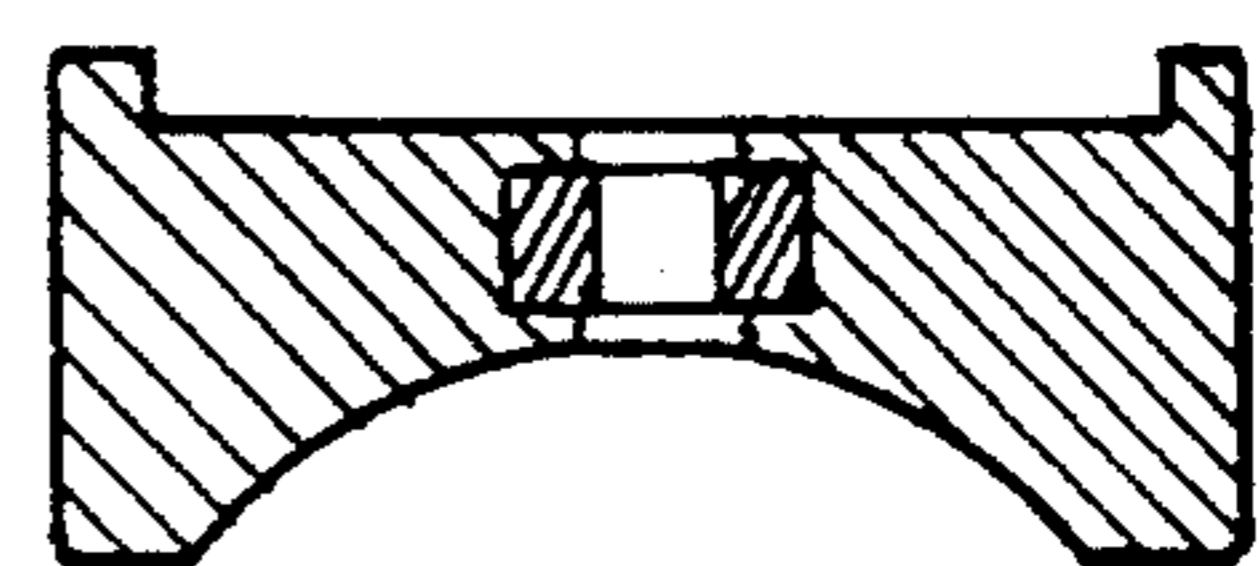

FIG. 8