



US00D349977S

# United States Patent [19]

[11] Patent Number: **Des. 349,977**

Shen

[45] Date of Patent: **\*\* Aug. 23, 1994**

[54] **COSMETIC CASE**

[75] Inventor: **Wen-Chang Shen, Tainan, Taiwan**

[73] Assignee: **Mei Shual Cosmetics Co., Ltd., Tainan, Taiwan**

[\*\*] Term: **14 Years**

[21] Appl. No.: **5,899**

[22] Filed: **Mar. 15, 1993**

[52] U.S. Cl. .... **D28/78**

[58] Field of Search ..... **D9/341, 347, 420-423; 132/293-297, 301, 303, 314-317; 206/275, 581, 823; 220/DIG. 26; D28/77-84**

[56] **References Cited**

**U.S. PATENT DOCUMENTS**

D. 103,137	2/1937	Wallenthin	.....	D28/78
D. 140,440	2/1945	Crane	.....	D28/78
D. 178,590	8/1956	Barbieri	.....	D9/420
D. 229,116	11/1973	Ishii	.....	D28/83
D. 281,915	12/1985	Sussman	.....	D28/83
D. 316,763	5/1991	Ferrari	.....	D28/83
2,175,674	10/1939	Shields	.....	220/DIG. 26
2,461,711	2/1949	Wewetzer	.....	D28/78 X

**OTHER PUBLICATIONS**

“Hong Kong Enterprise”; Oct. 1989, p. 372: compact no T-85 on lower right.

“Beautiful Visions” Special 1990 money saving edition; p. 25—compact at top.

“Hong Kong Trader”, Apr. 1991; p. 4 top of page; eye shadow kit on right.

*Primary Examiner*—Bernard Ansher

*Assistant Examiner*—C. Tuttle

*Attorney, Agent, or Firm*—Finnegan, Henderson, Farabow, Garrett & Dunner

[57] **CLAIM**

The ornamental design for cosmetic case, as shown and described.

**DESCRIPTION**

FIG. 1 is a perspective view of cosmetic case showing my new design;

FIG. 2 is a front elevational view thereof;

FIG. 3 is a rear elevational view thereof;

FIG. 4 is a left side elevational view thereof;

FIG. 5 is a right side elevational view thereof;

FIG. 6 is a top plan view thereof; and,

FIG. 7 is a bottom plan view thereof.

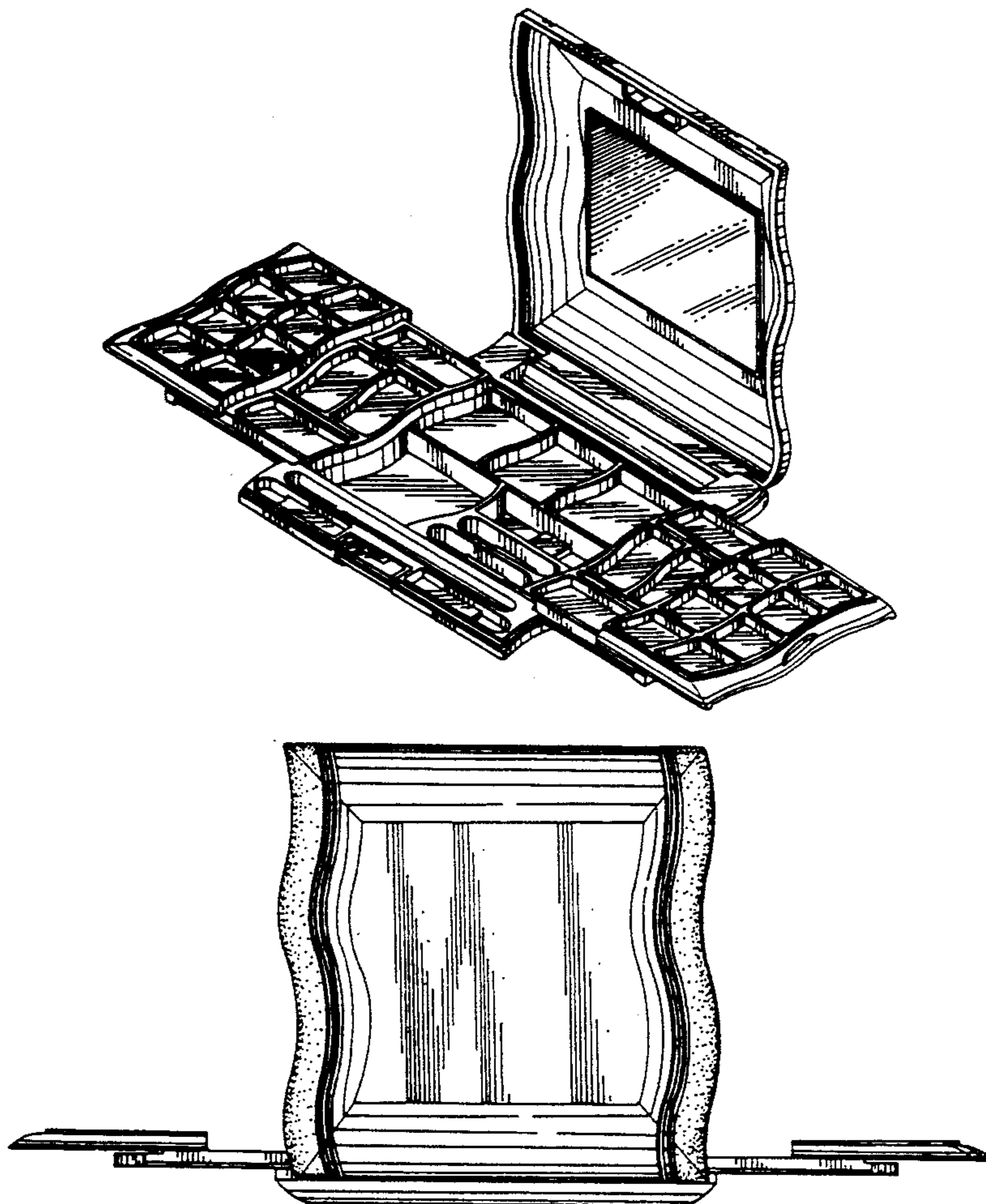

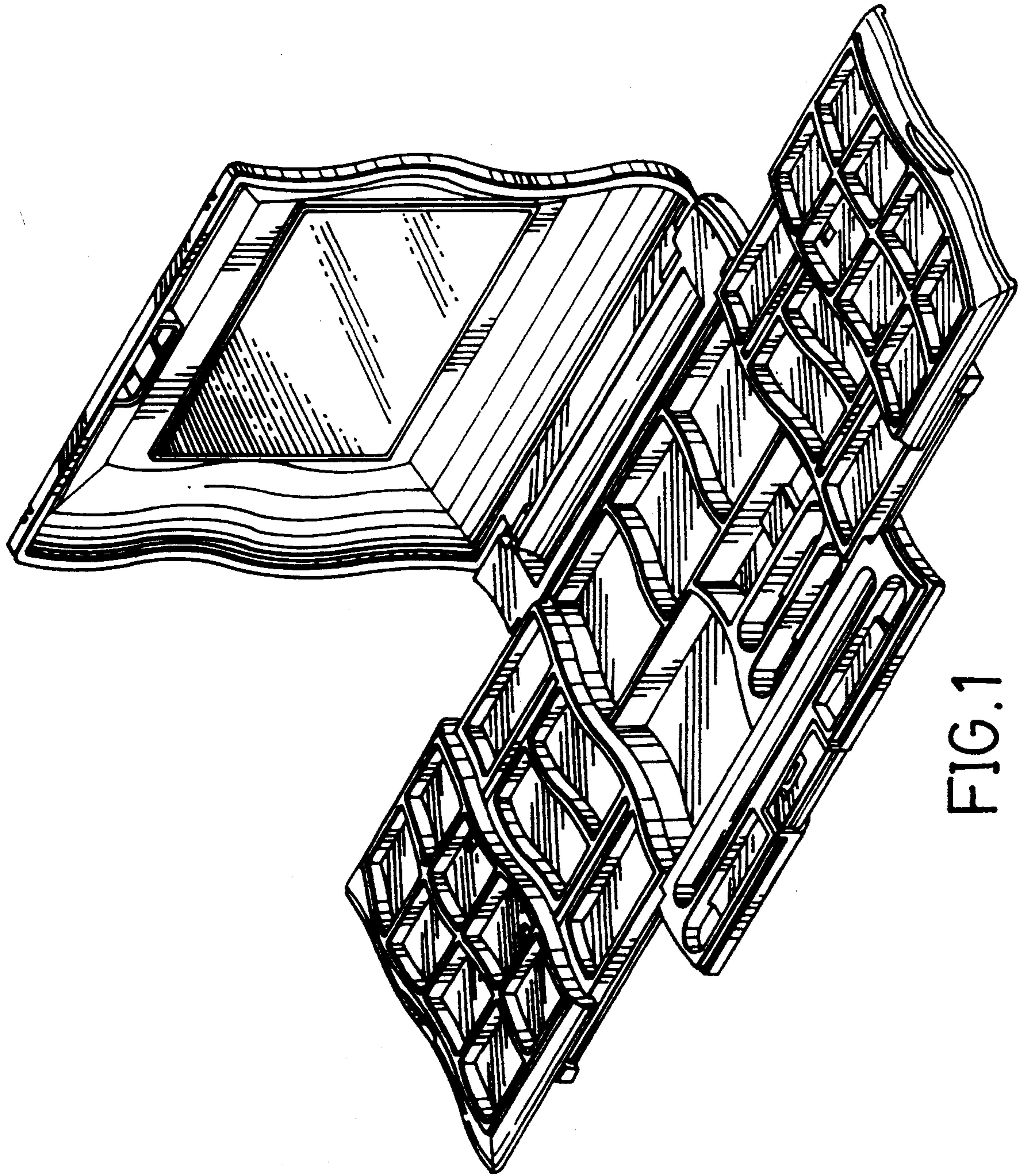

FIG. 1

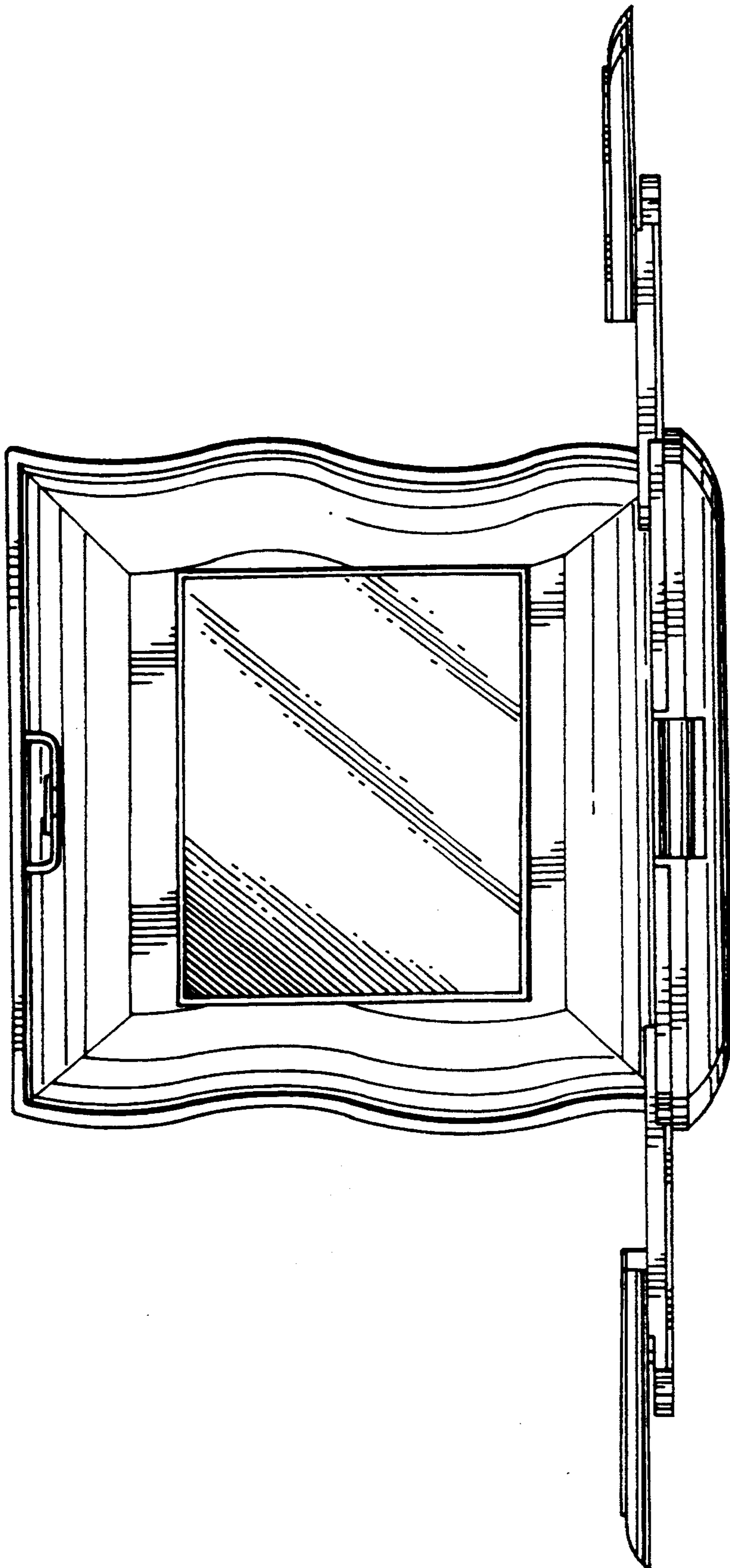

FIG. 2

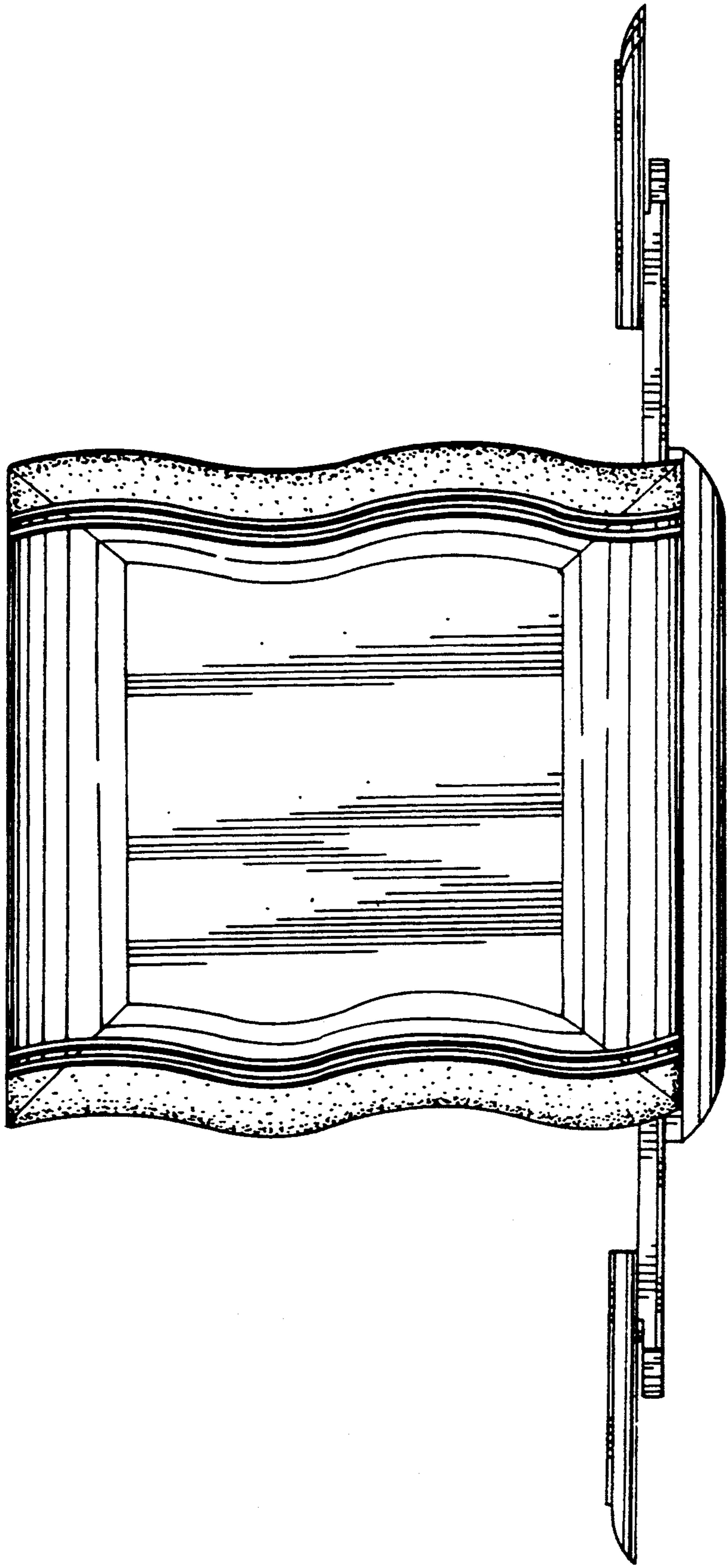

FIG. 3

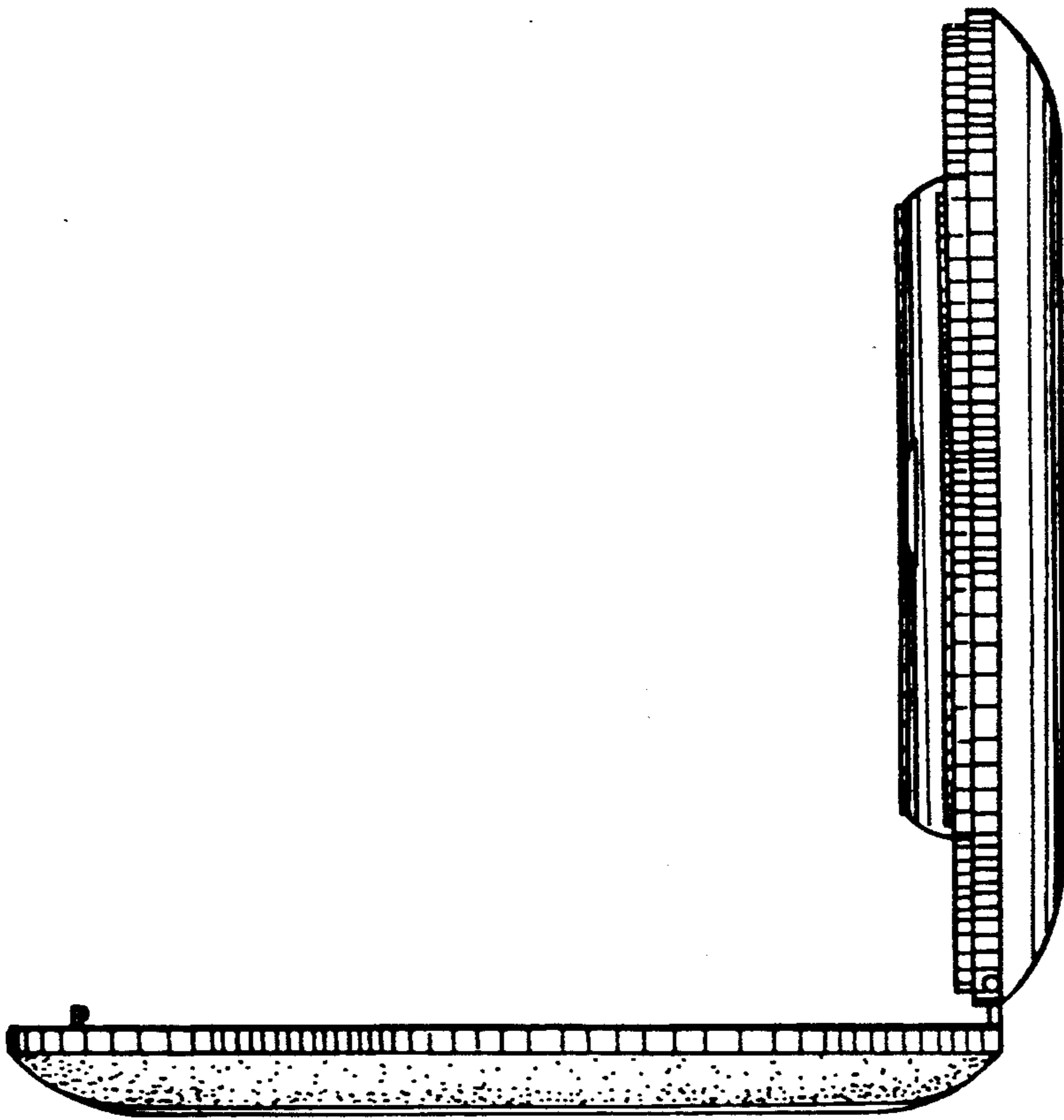

FIG. 4

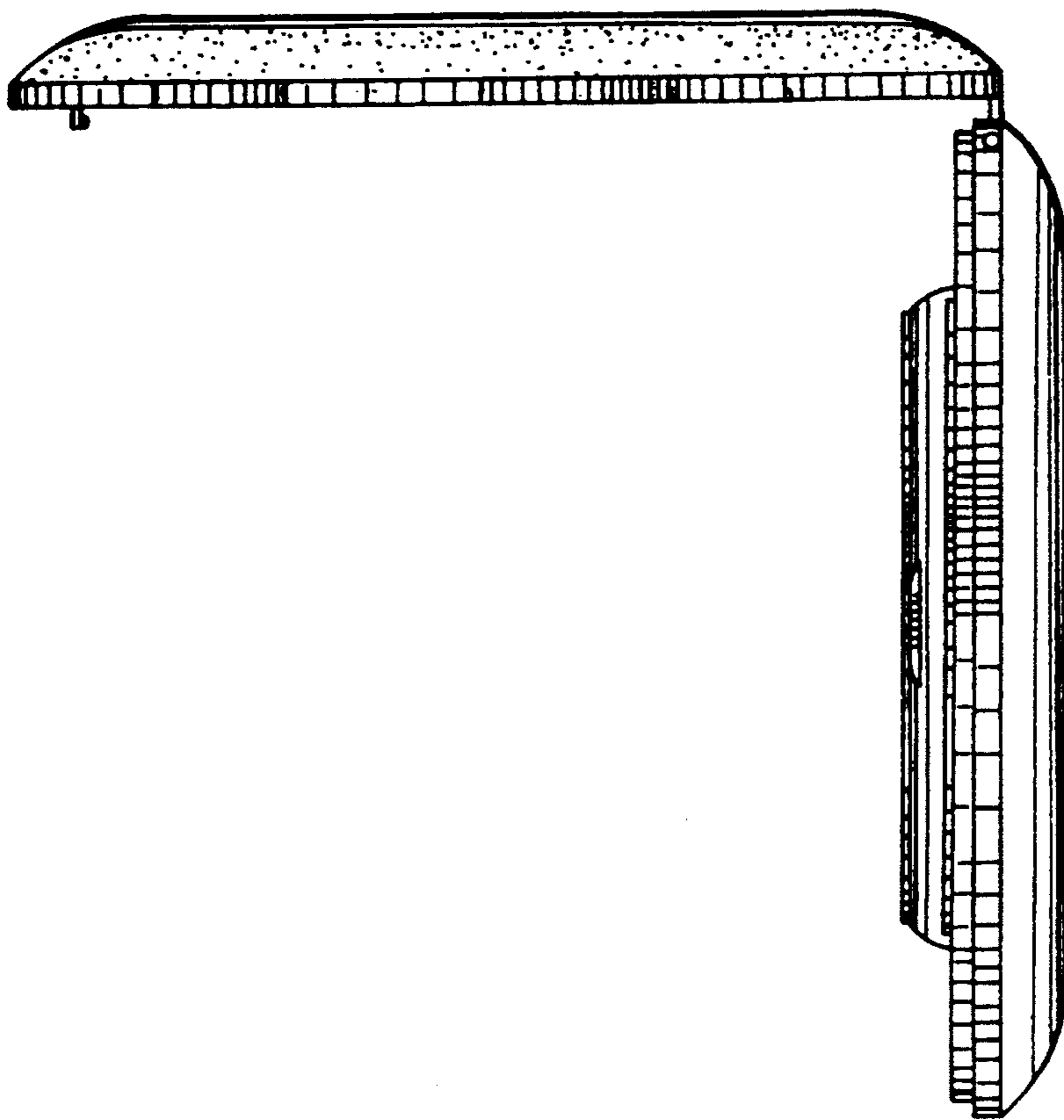

FIG. 5

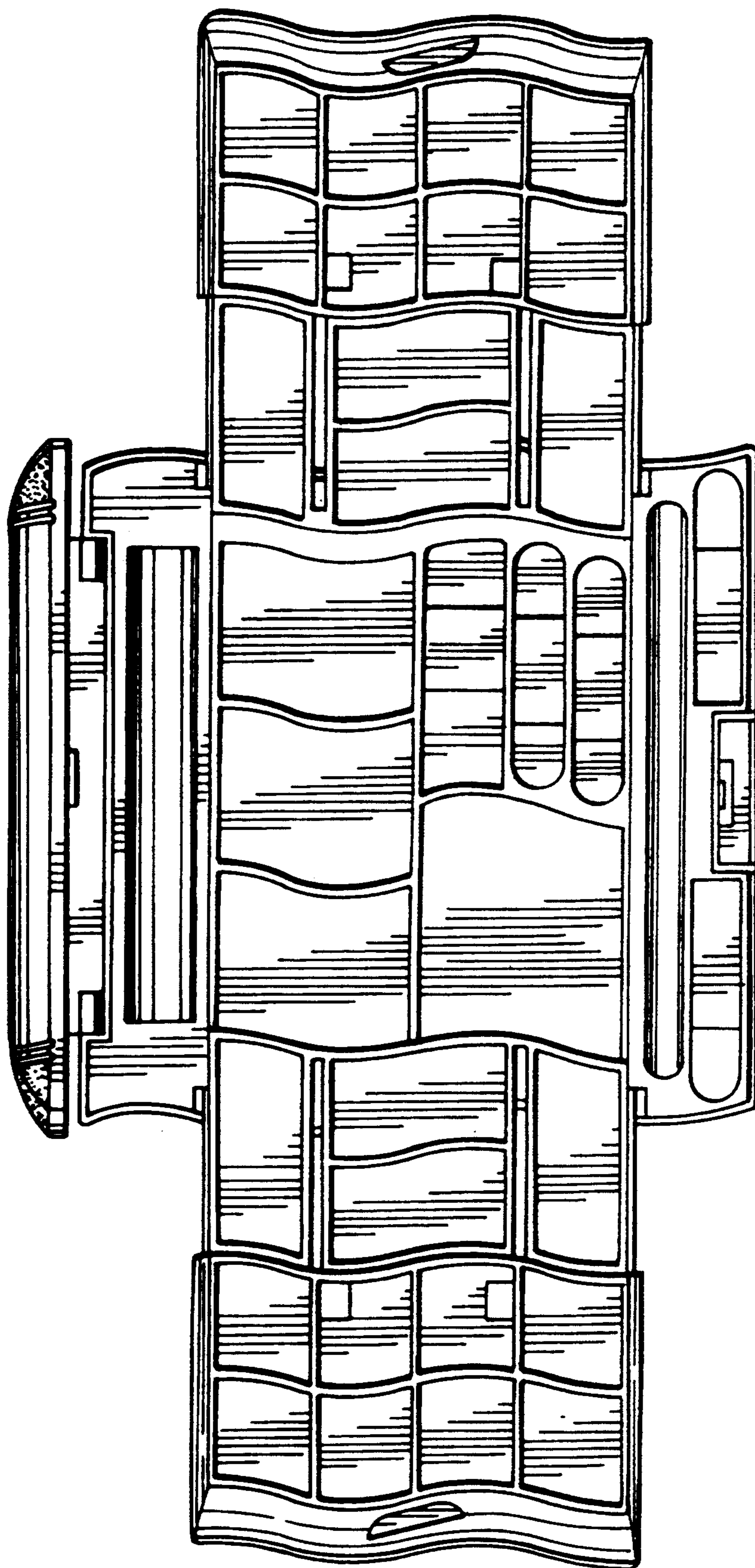

FIG. 6

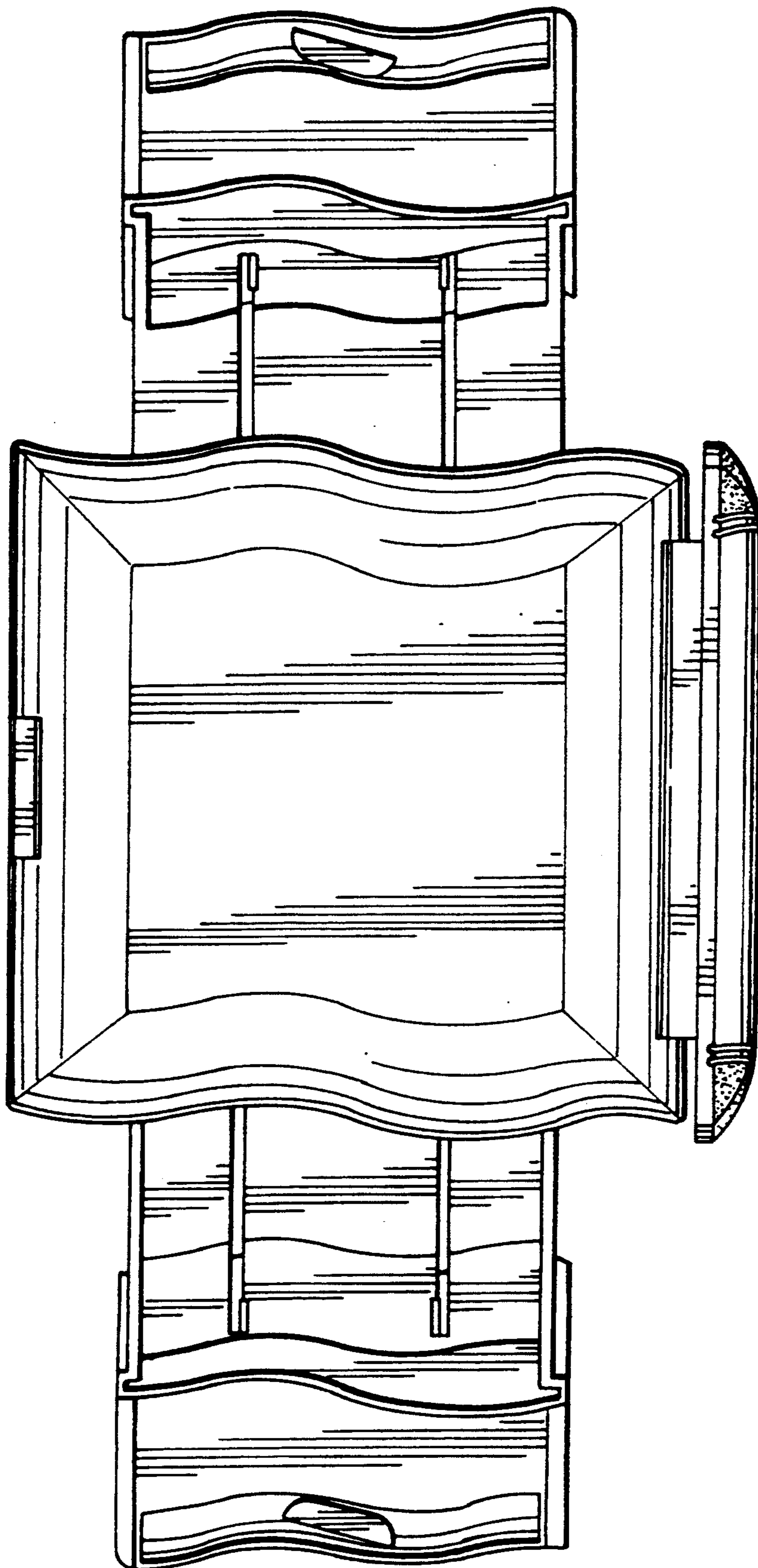

FIG. 7