



US00D349943S

# United States Patent [19]

[11] Patent Number: **Des. 349,943**

Takizawa et al.

[45] Date of Patent: **\*\* Aug. 23, 1994**

## [54] REEL SEAT FOR A FISHING ROD

## DESCRIPTION

[75] Inventors: **Shin-ya Takizawa**, Musashino;  
**Shigeru Yamamoto**; **Hideyuki Furuya**, both of Higashikurume, all of Japan

[73] Assignee: **Daiwa Seiko, Inc.**, Tokyo, Japan

[\*\*] Term: **14 Years**

[21] Appl. No.: **5,056**

[22] Filed: **Feb. 22, 1993**

### [30] Foreign Application Priority Data

Aug. 27, 1992 [JP]	Japan	4-25437
Jan. 25, 1993 [JP]	Japan	5-1624
[52] U.S. Cl.		<b>D22/142</b>
[58] Field of Search	43/18.1, 18.5, 20, 22, 43/23;	<b>D22/142</b>

### [56] References Cited

#### U.S. PATENT DOCUMENTS

D. 288,113	2/1987	Childre	D22/142
D. 288,114	2/1987	Childre	D22/142
D. 329,272	9/1992	Takizawa	D22/142
D. 329,273	9/1992	Oyama et al.	D22/142

*Primary Examiner*—A. Hugo Word  
*Assistant Examiner*—Doris V. Coles  
*Attorney, Agent, or Firm*—Bacon & Thomas

### [57] CLAIM

The ornamental design for a reel seat for a fishing rod, as shown and described.

FIG. 1 is a left side elevational view of a reel seat for a fishing rod, showing our new design;  
 FIG. 2 is a front elevational view thereof;  
 FIG. 3 is a right side elevational view thereof;  
 FIG. 4 is a bottom plan view thereof;  
 FIG. 5 is a top plan view thereof;  
 FIG. 6 is a rear elevational view thereof;  
 FIG. 7 is a cross-sectional view thereof taken on line 7—7 in FIG. 3;  
 FIG. 8 is a cross-sectional view thereof taken on line 8—8 in FIG. 3;  
 FIG. 9 is a cross-sectional view thereof taken on line 9—9 in FIG. 3;  
 FIG. 10 is a cross-sectional view thereof taken on line 10—10 in FIG. 3;  
 FIG. 11 is a cross-sectional view thereof taken on line 11—11 in FIG. 3;  
 FIG. 12 is a reference view showing the reel seat for a fishing rod in a state of use;  
 FIG. 13 is a left side elevational view of a second embodiment of the reel seat for a fishing rod;  
 FIG. 14 is a front elevational view thereof;  
 FIG. 15 is a right side elevational view thereof;  
 FIG. 16 is a bottom plan view thereof;  
 FIG. 17 is a top plan view thereof;  
 FIG. 18 is a rear elevational view thereof;  
 FIG. 19 is a cross-sectional view thereof taken on line 19—19 in FIG. 15;  
 FIG. 20 is a cross-sectional view thereof taken on line 20—20 in FIG. 15;  
 FIG. 21 is a cross-sectional view thereof taken on line 21—21 in FIG. 15;  
 FIG. 22 is a cross-sectional view thereof taken on line 22—22 in FIG. 15;  
 FIG. 23 is a cross-sectional view thereof taken on line 23—23 in FIG. 15; and,  
 FIG. 24 is a reference view showing the reel seat for a fishing rod in a state of use.

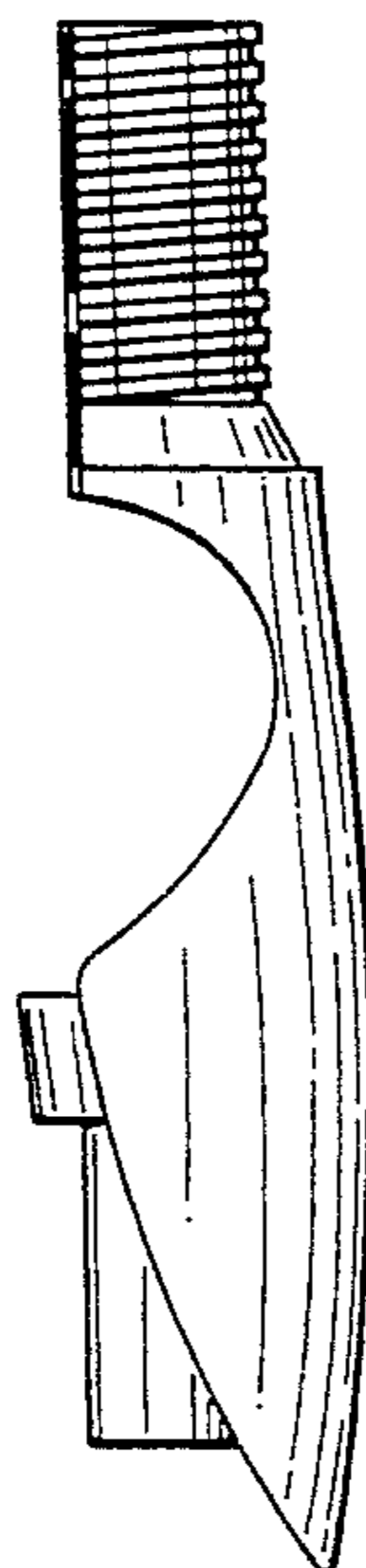

FIG. 1

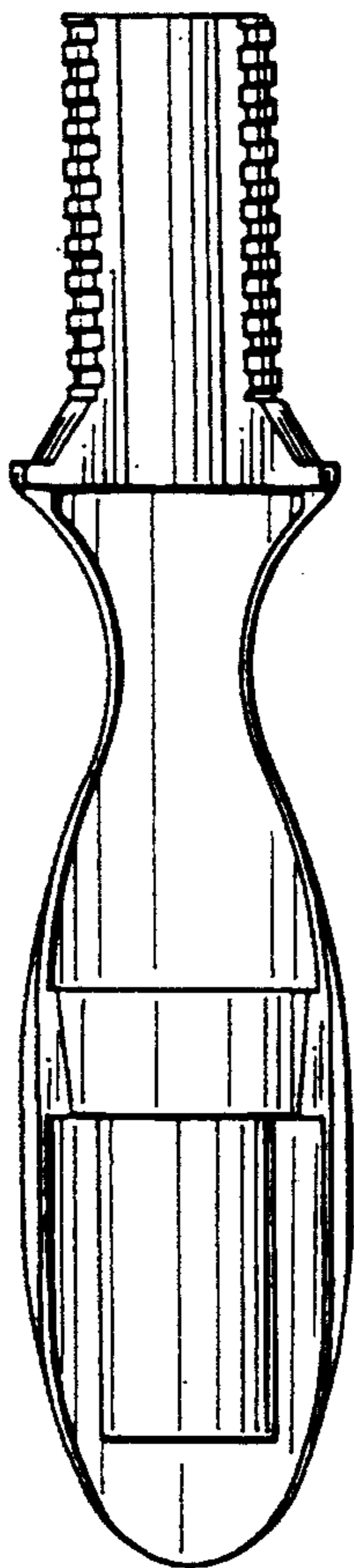

FIG. 2



FIG. 3

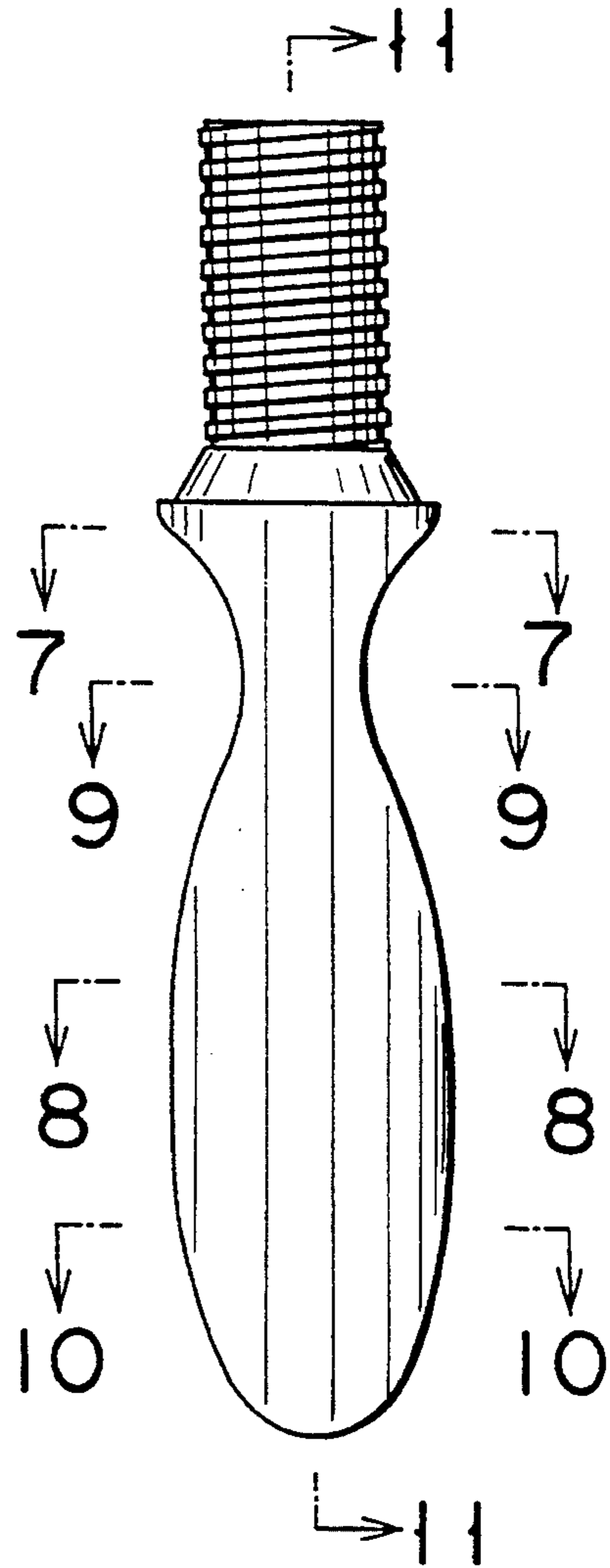

FIG. 4

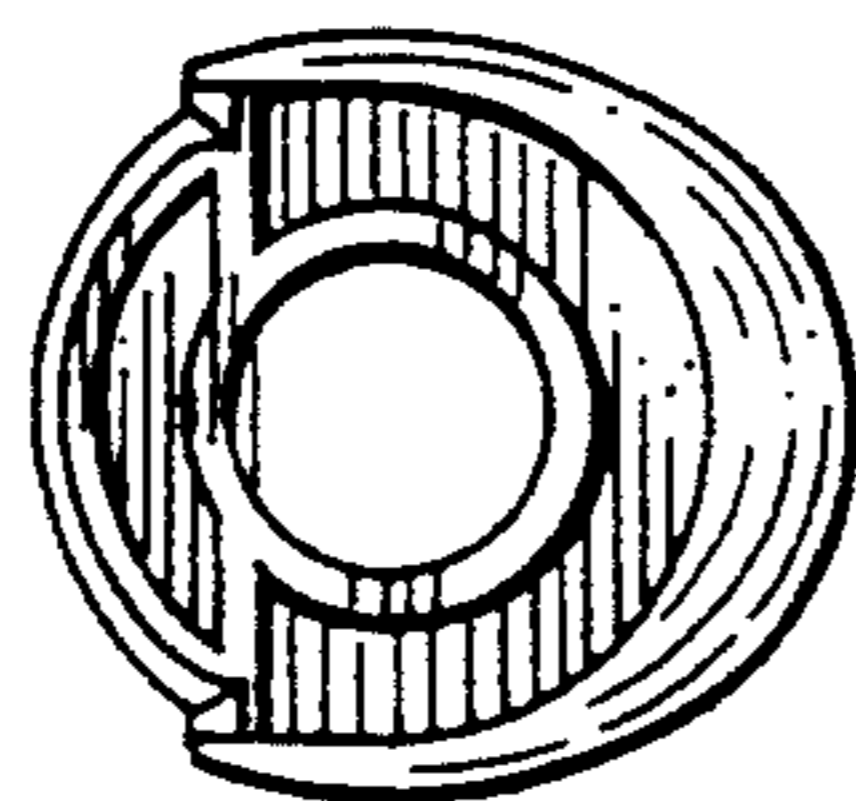

FIG. 5

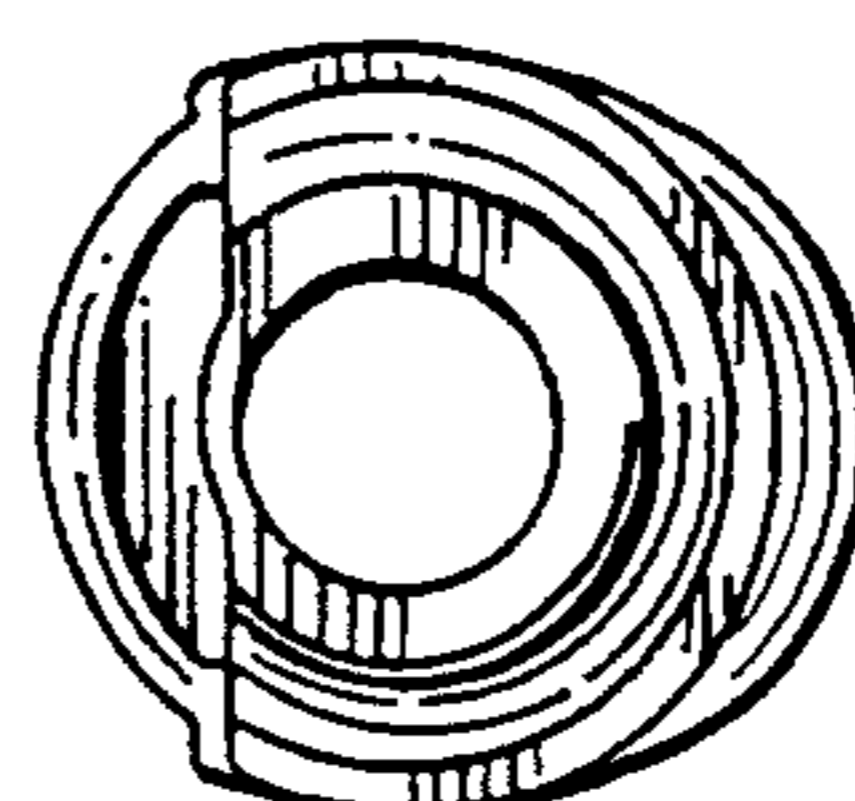

FIG. 6

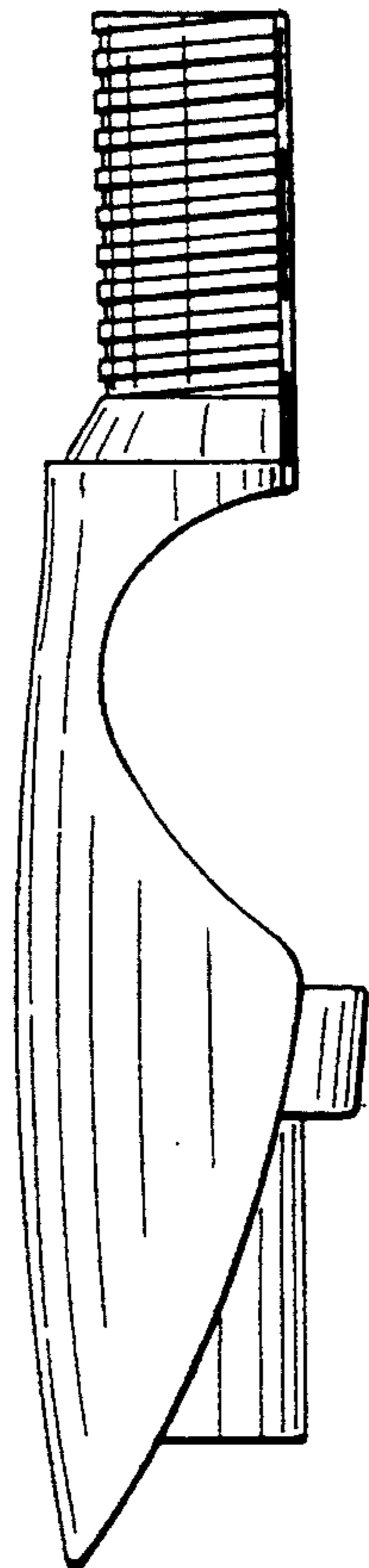

FIG. 11

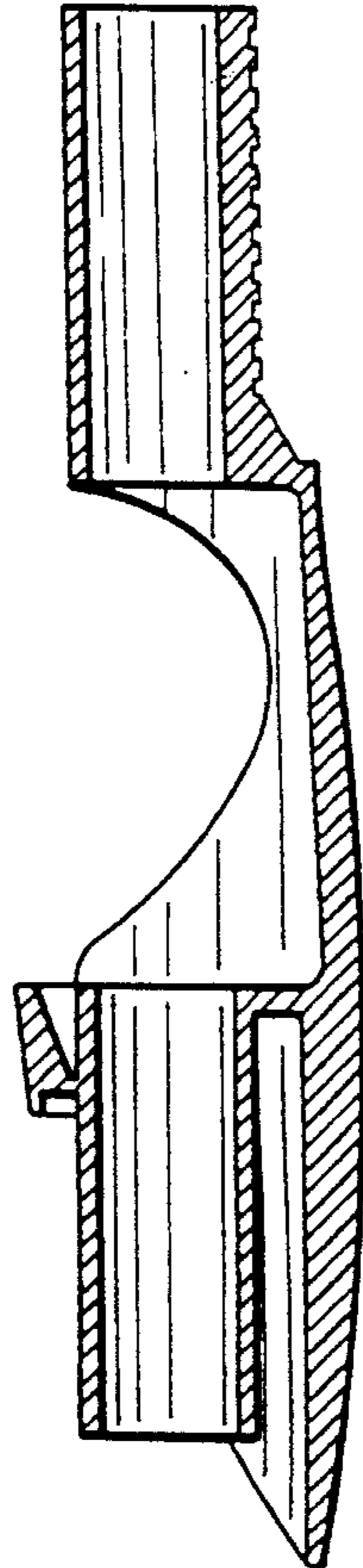

FIG. 12

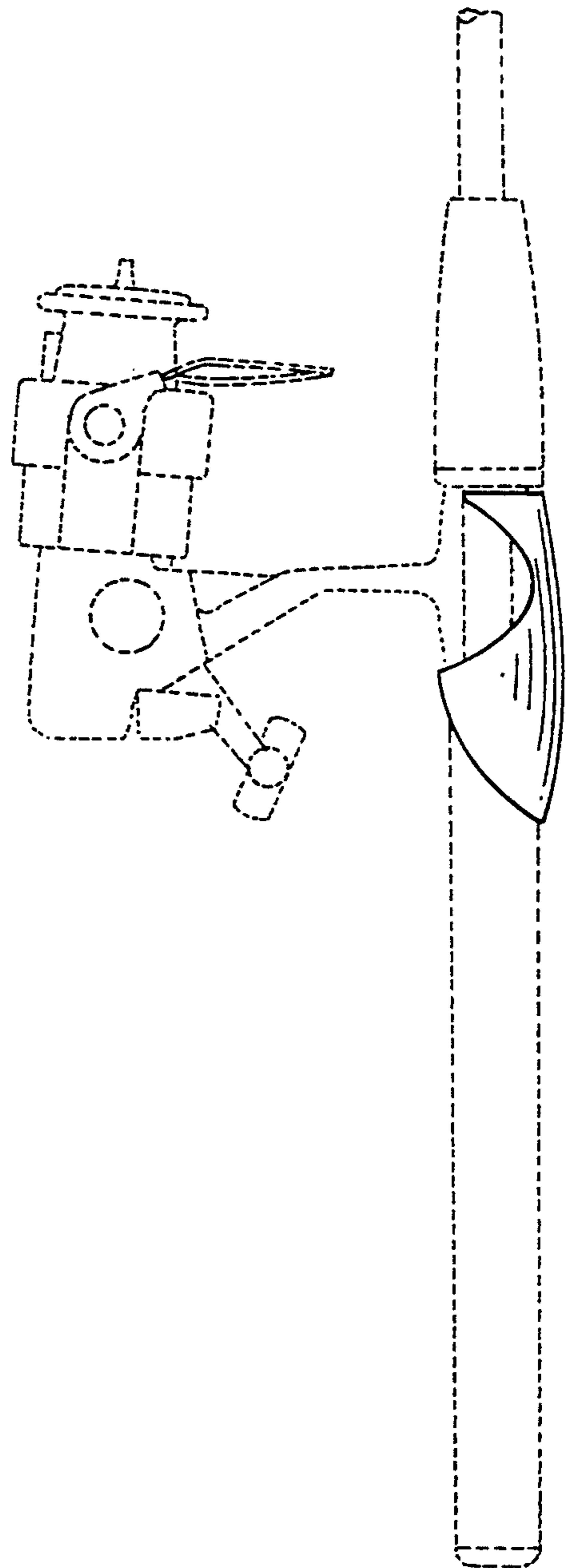

FIG. 7

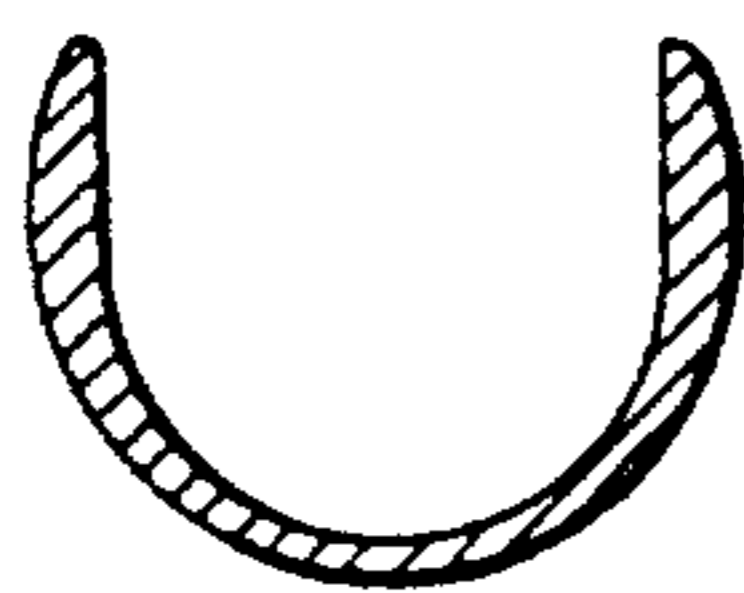

FIG. 9



FIG. 8

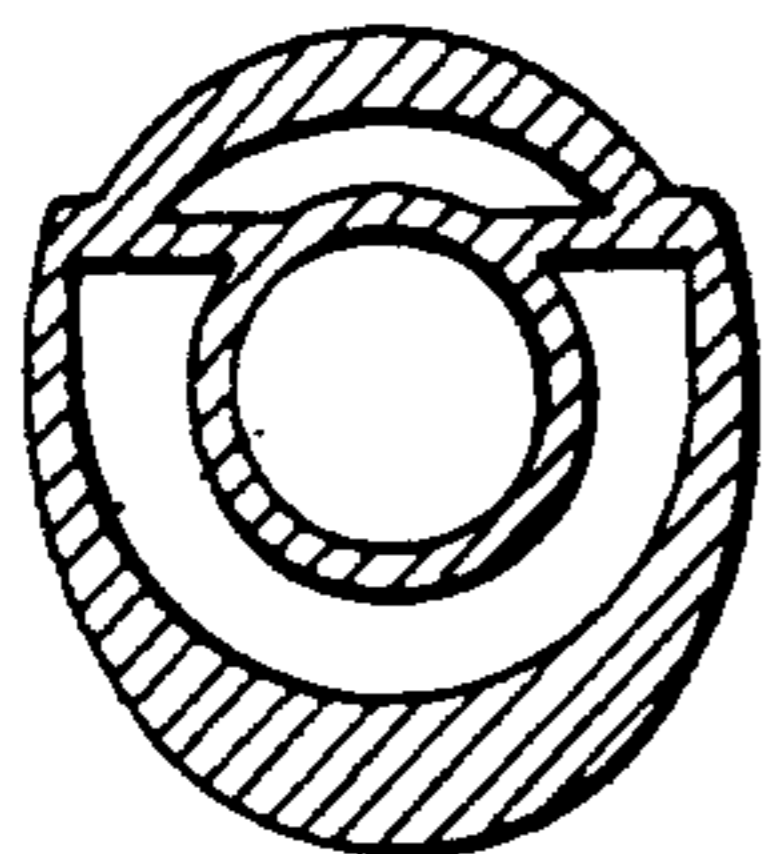

FIG. 10

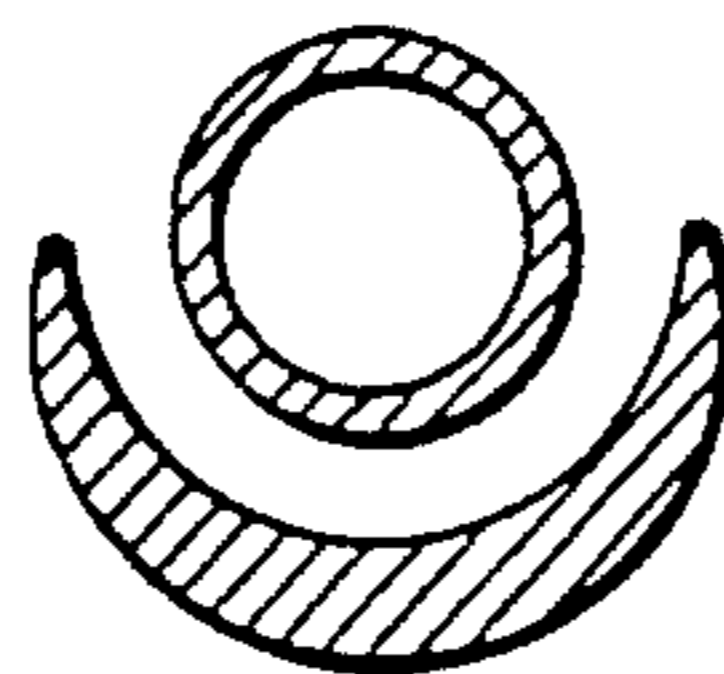

FIG. 13

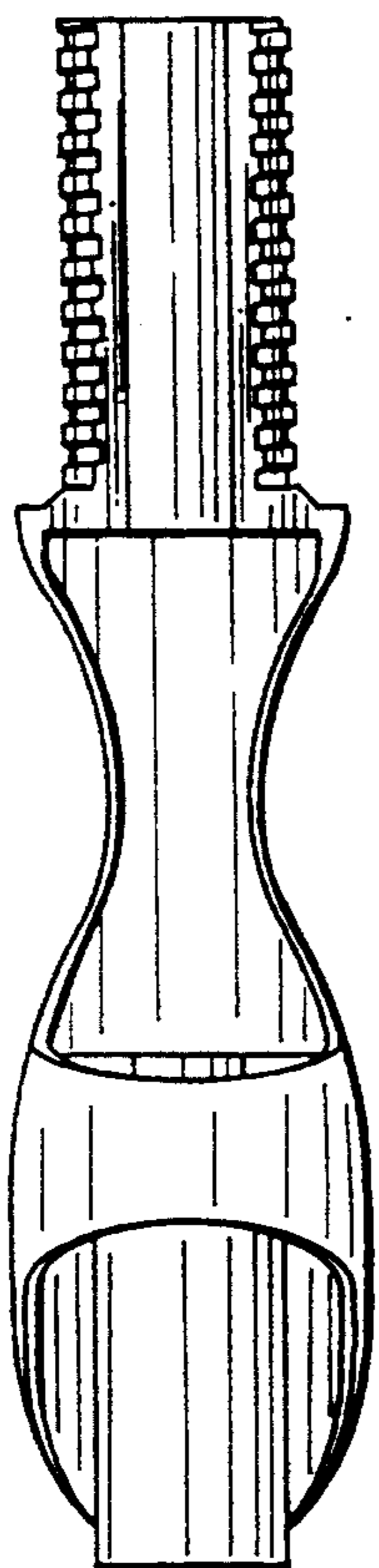

FIG. 14



FIG. 15

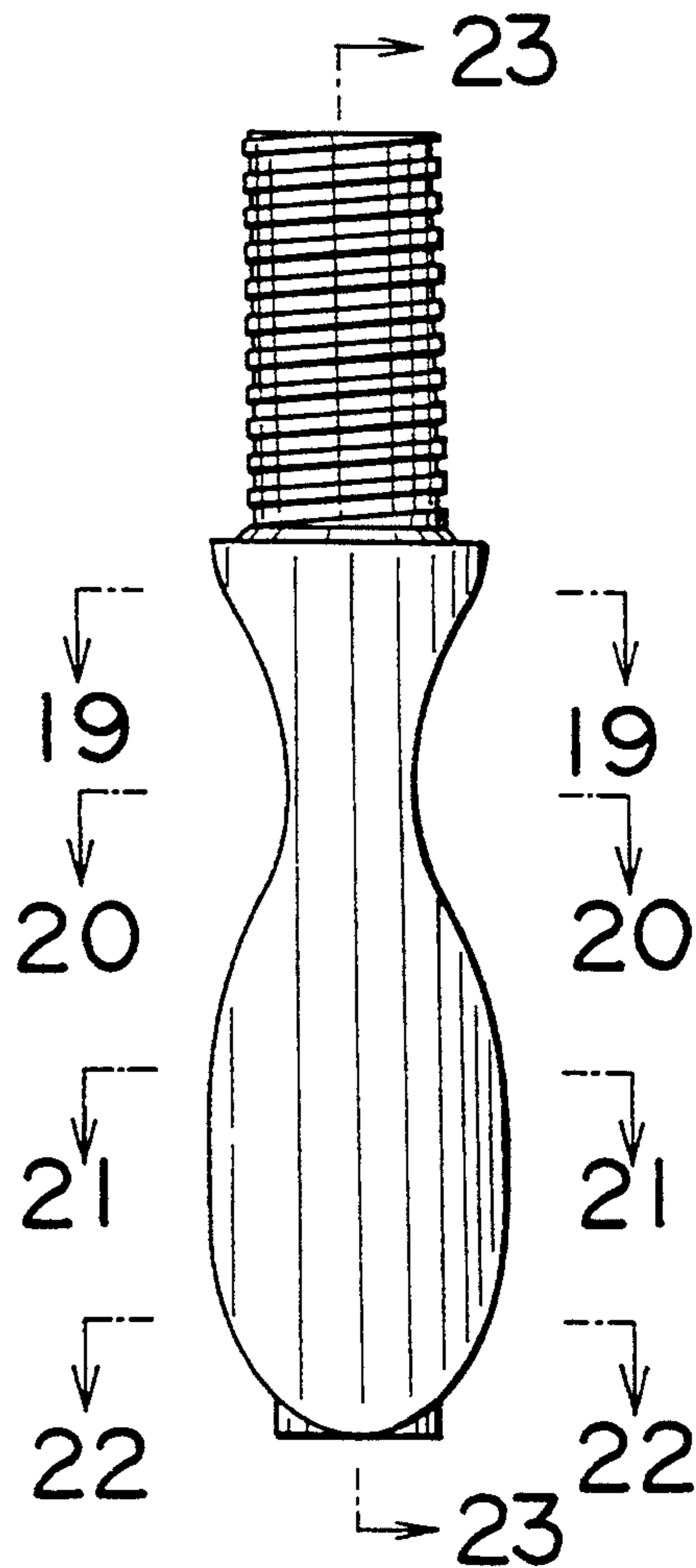

FIG. 16

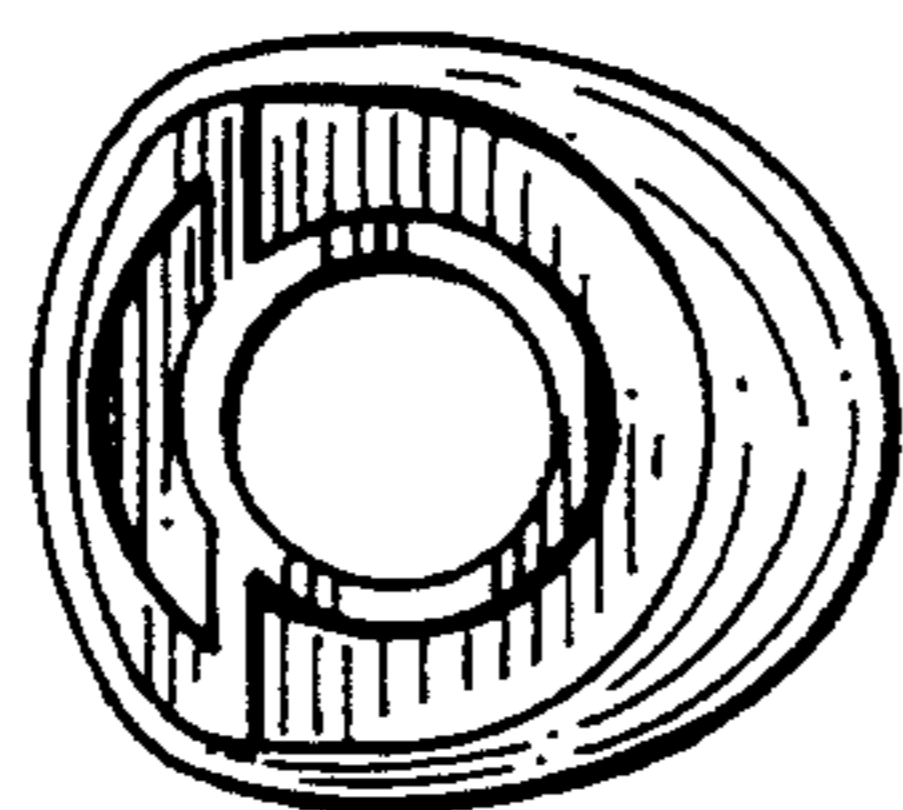

FIG. 17

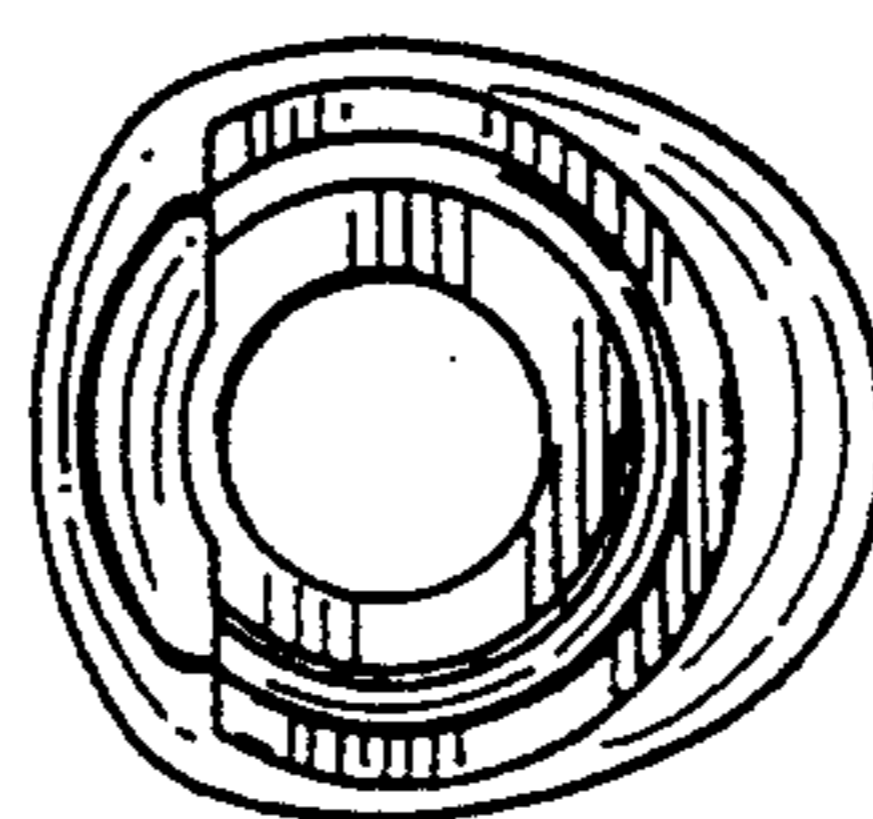

FIG. 18

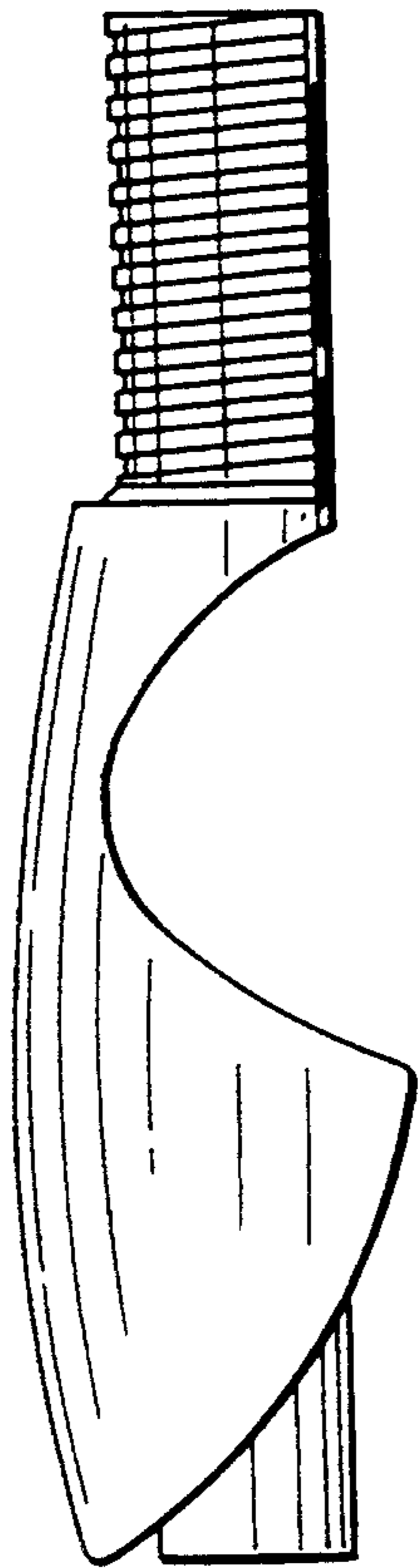

FIG. 23

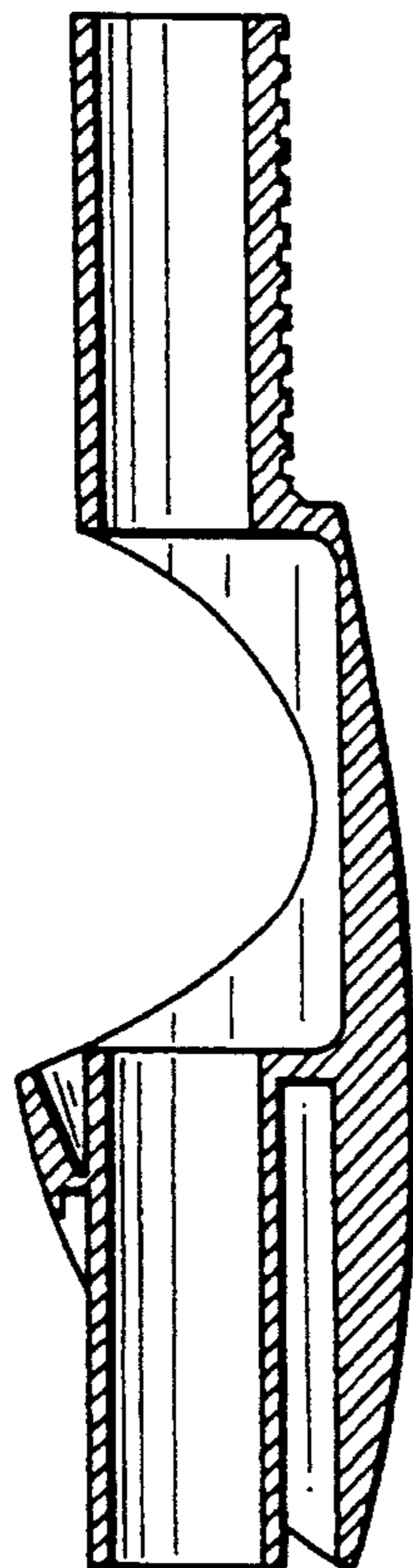

FIG. 24

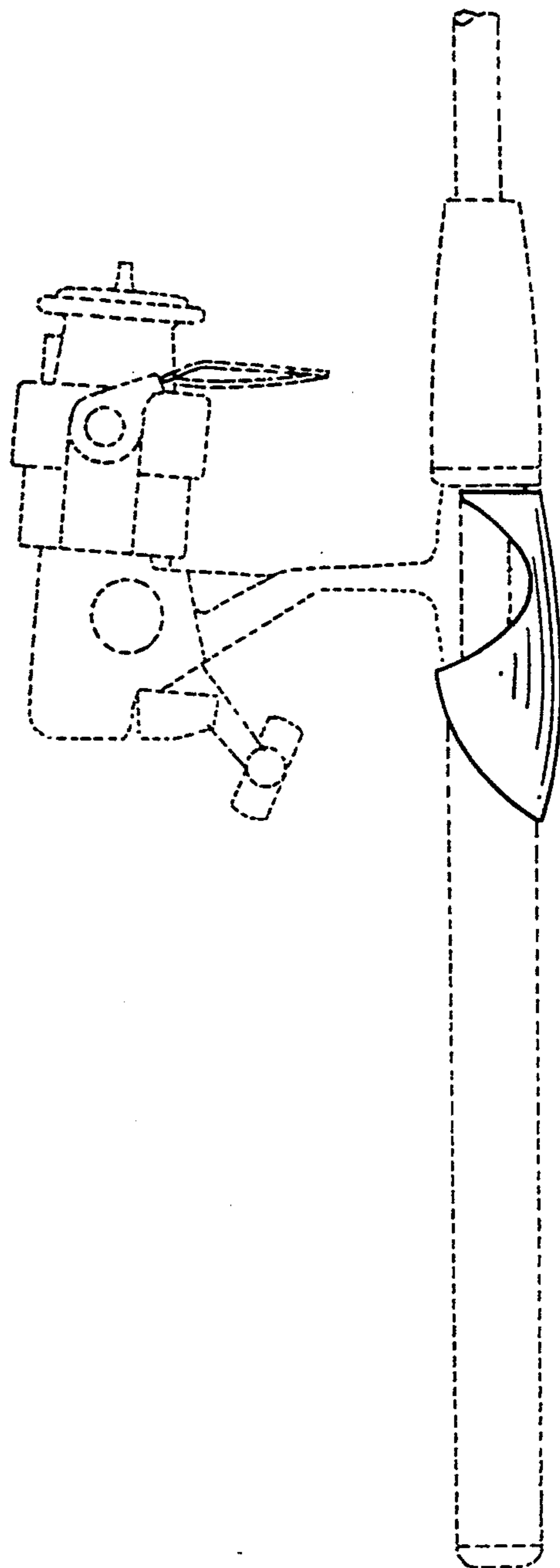

FIG. 19

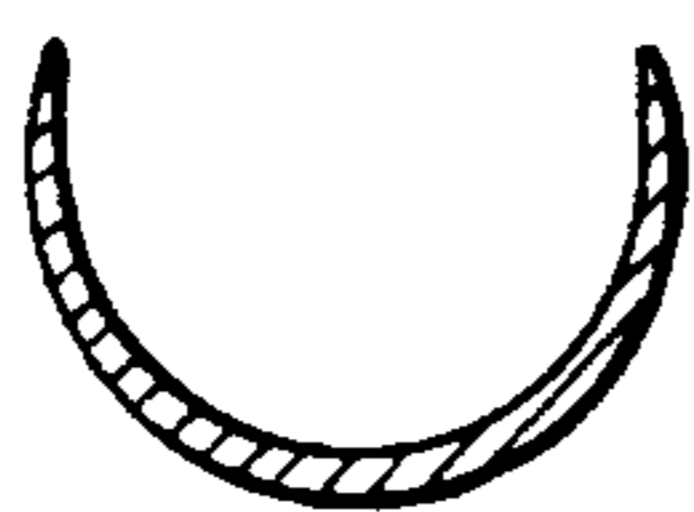

FIG. 20



FIG. 21

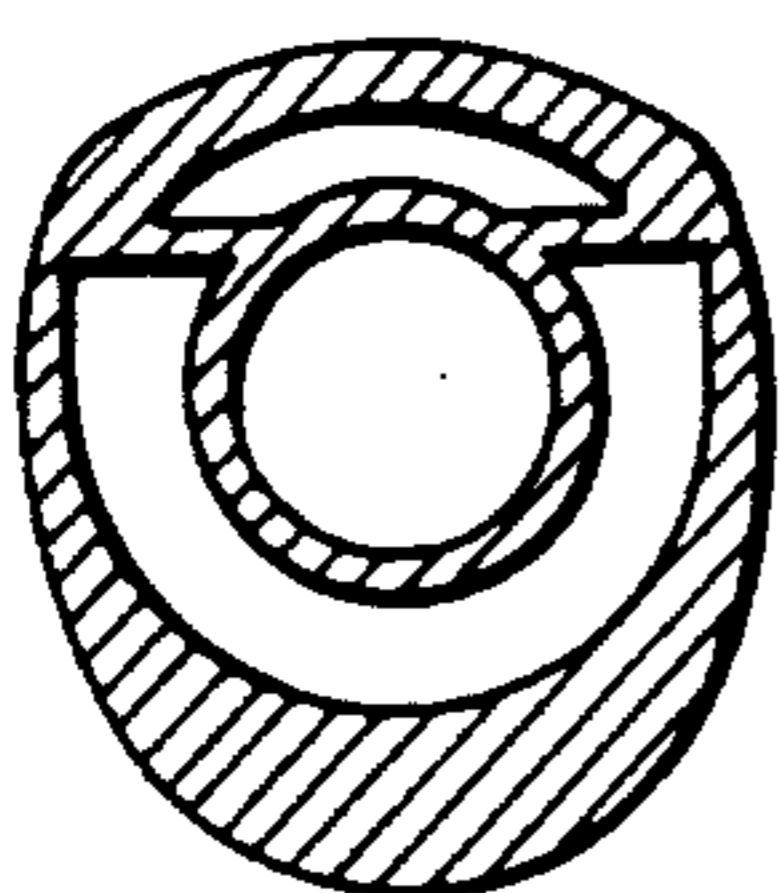

FIG. 22

