



US00D349912S

United States Patent [19]

[11] Patent Number: **Des. 349,912**

Brewer

[45] Date of Patent: **** Aug. 23, 1994**

[54] **ADJUSTABLE STAND FOR MOUNTING A VIDEO CAMERA**

[76] Inventor: **Vernon S. Brewer, 967 S. New St., West Chester, Pa. 19382**

[**] Term: **14 Years**

[21] Appl. No.: **949,056**

[22] Filed: **Sep. 22, 1992**

[52] U.S. Cl. **D16/242**

[58] Field of Search 248/123.1, 284, 447.2; 224/908; 354/81, 82, 293; 352/243; D16/237, 242, 243, 244, 245

[56] **References Cited**

U.S. PATENT DOCUMENTS

D. 275,202	8/1984	Barber	D16/242
D. 313,030	12/1990	Morton	D16/242
D. 329,449	9/1992	Brown et al.	D16/243
4,198,150	4/1980	Sloop	354/293
5,192,963	3/1993	Hill	354/81

Primary Examiner—Melvin B. Feifer
Assistant Examiner—Adir Aronovich
Attorney, Agent, or Firm—Dann, Dorfman, Herrell and Skillman

[57] **CLAIM**

The ornamental design for an adjustable stand for mounting a video camera, as shown and described.

DESCRIPTION

FIG. 1 is a left side elevation of an adjustable stand for mounting a video camera showing my new design, the right side elevation being a mirror image of FIG. 1; FIG. 2 is a rear elevation thereof; FIG. 3 is a front elevation thereof; FIG. 4 is a top plan view thereof; FIG. 5 is a bottom plan view thereof; and, FIG. 6 is a perspective view thereof, the stand being in an alternate position of that shown in FIG. 1. The broken line illustrations of the video camera and the work surface in FIG. 1 are for illustrative purposes only and form no part of the claimed design.

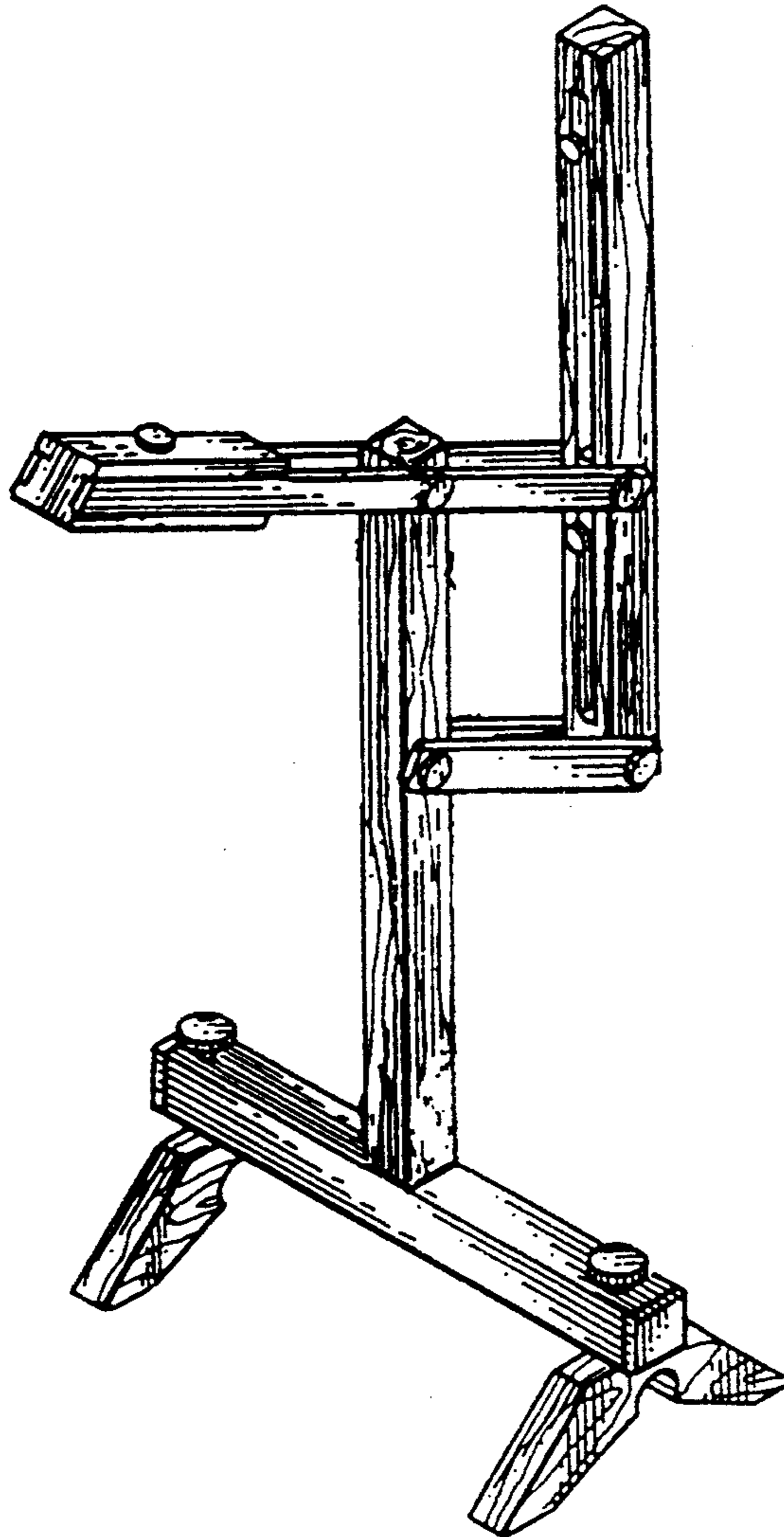

FIG. 1

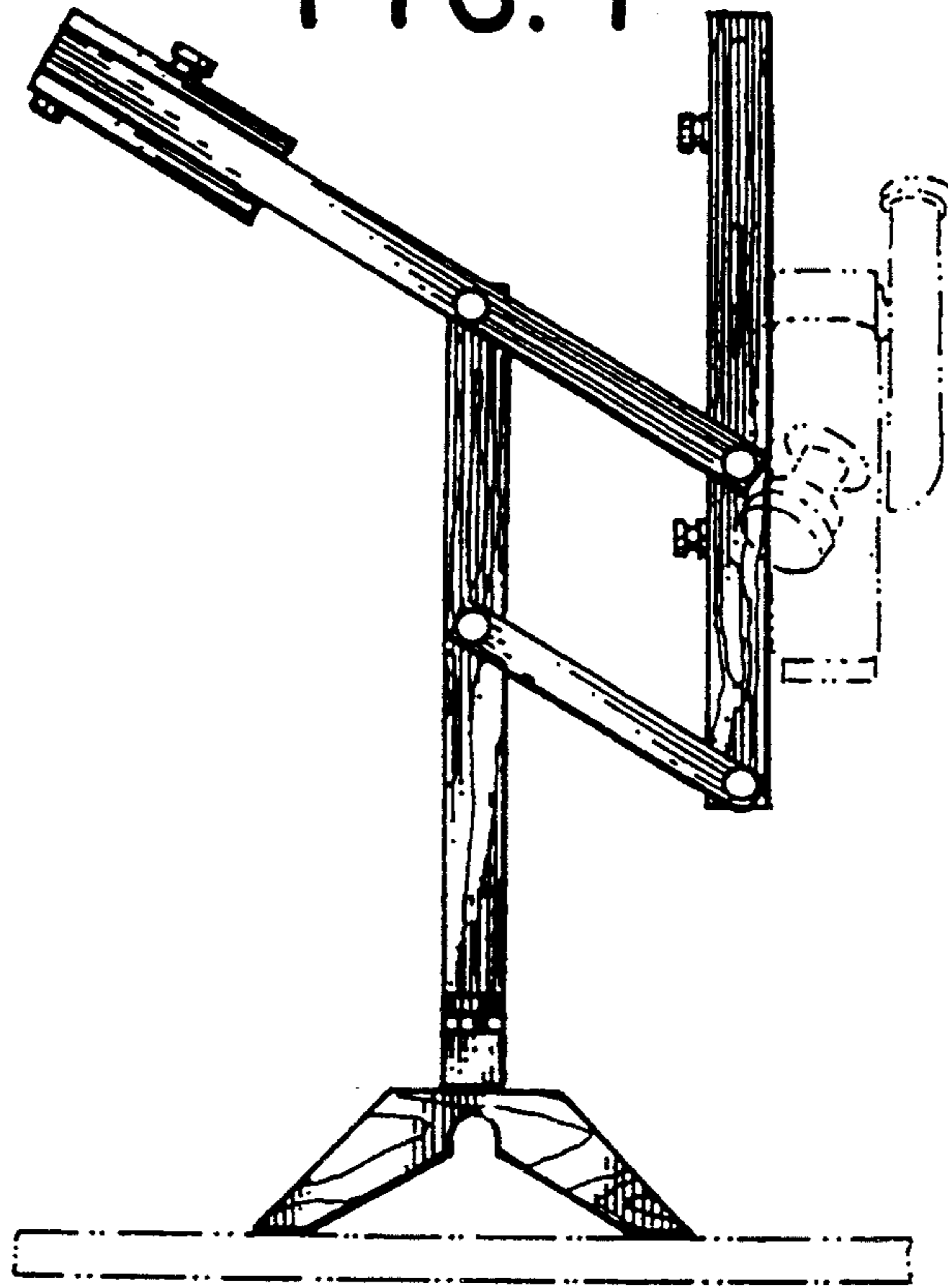

FIG. 2

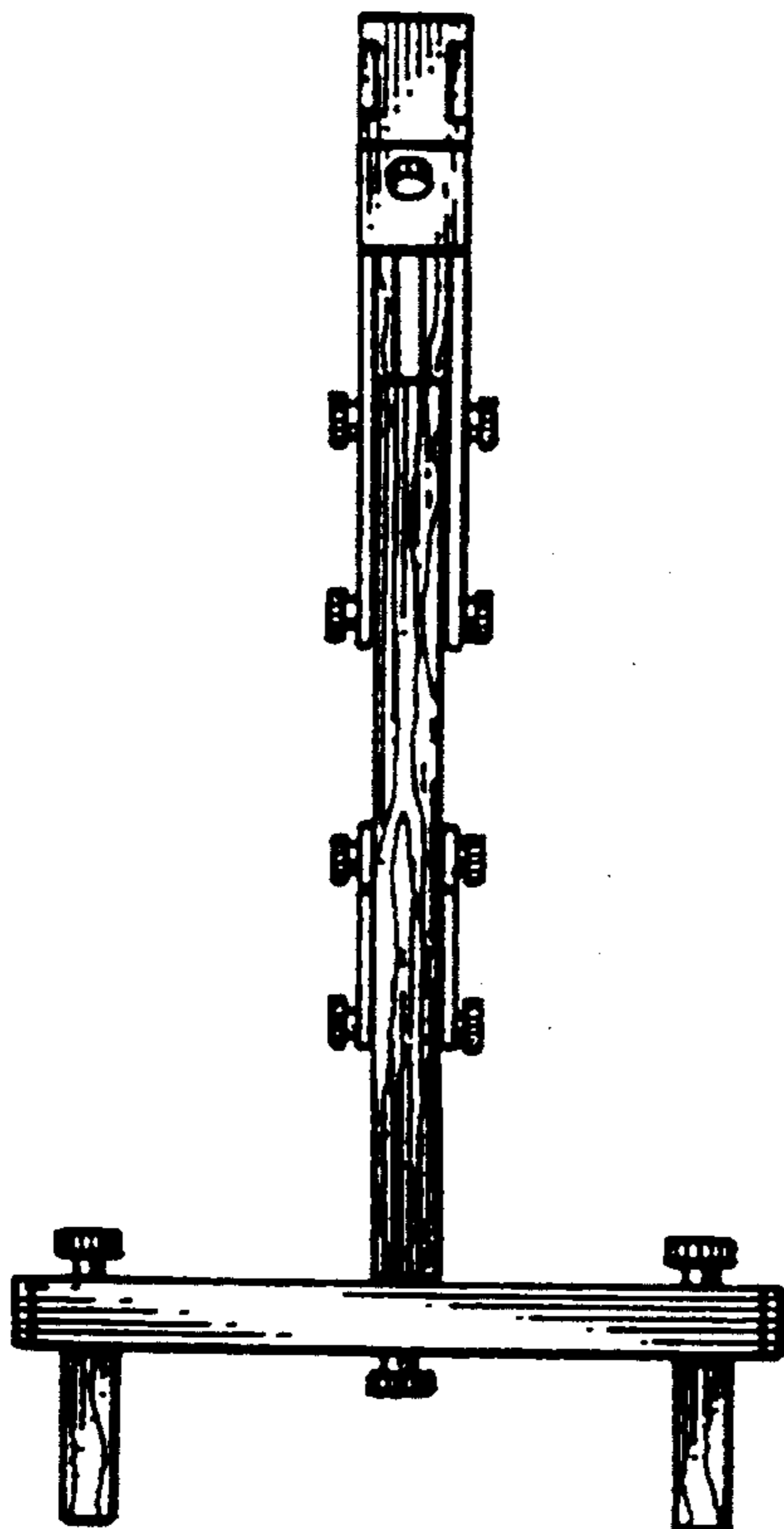

FIG. 3

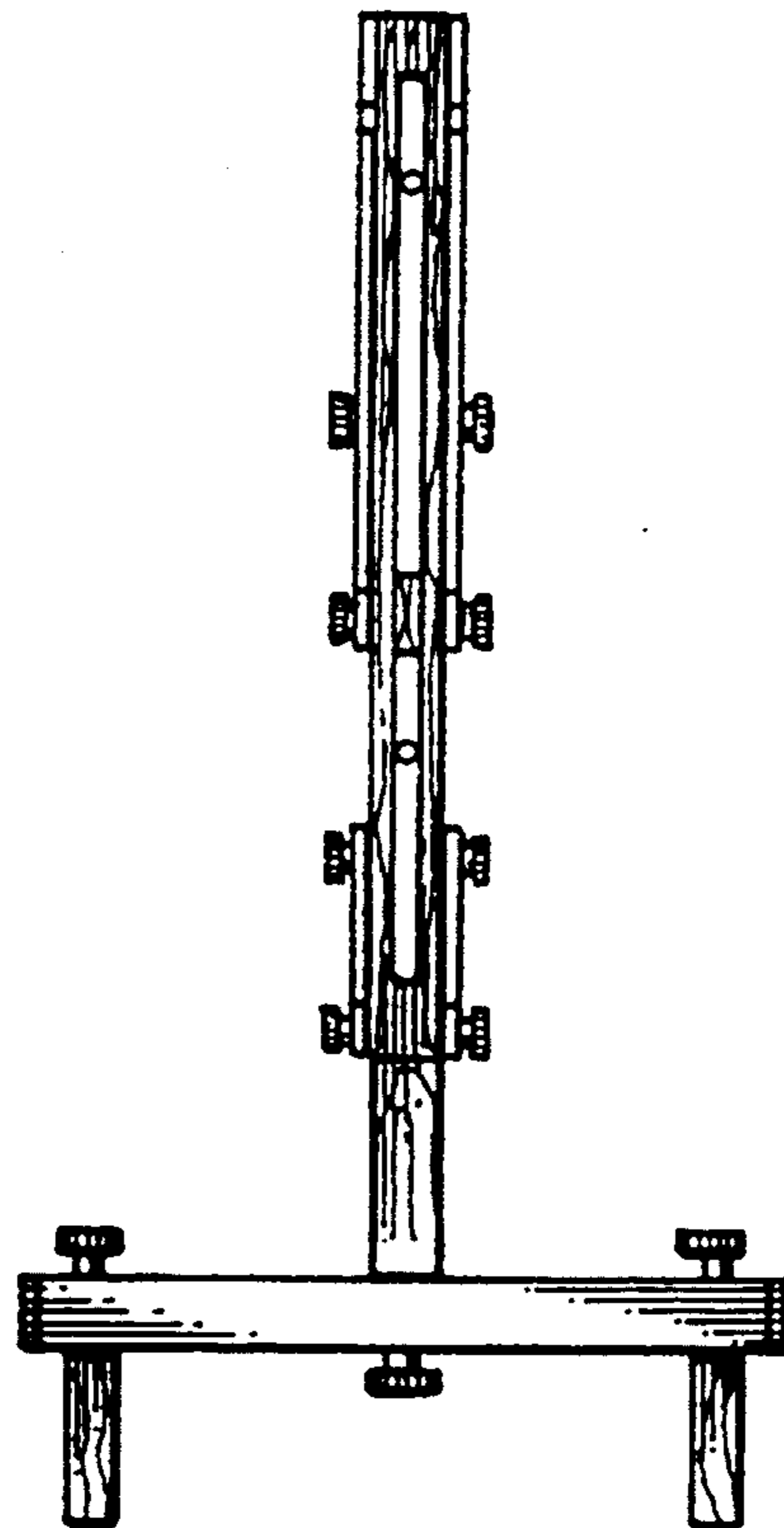

FIG. 4

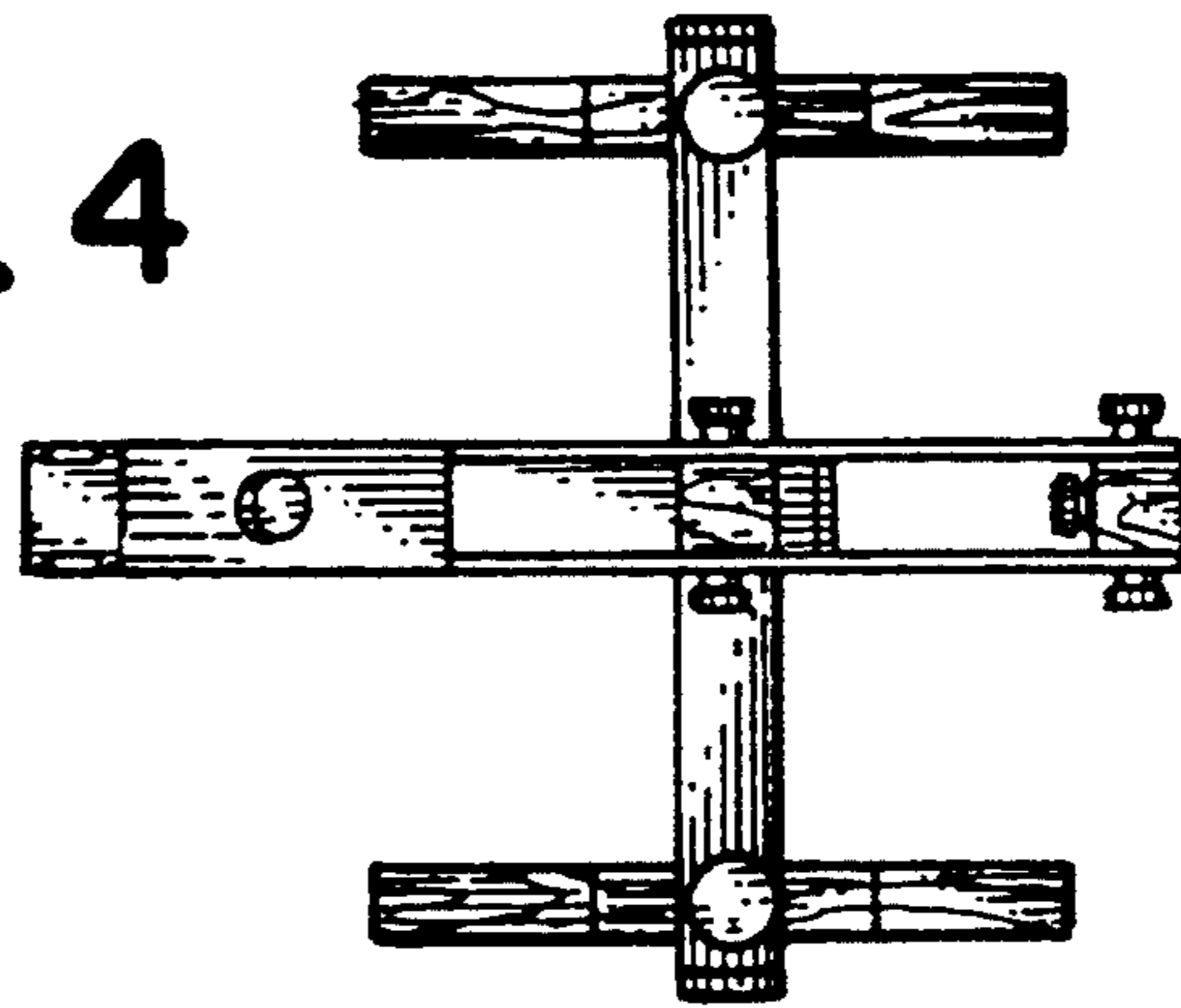

FIG. 5

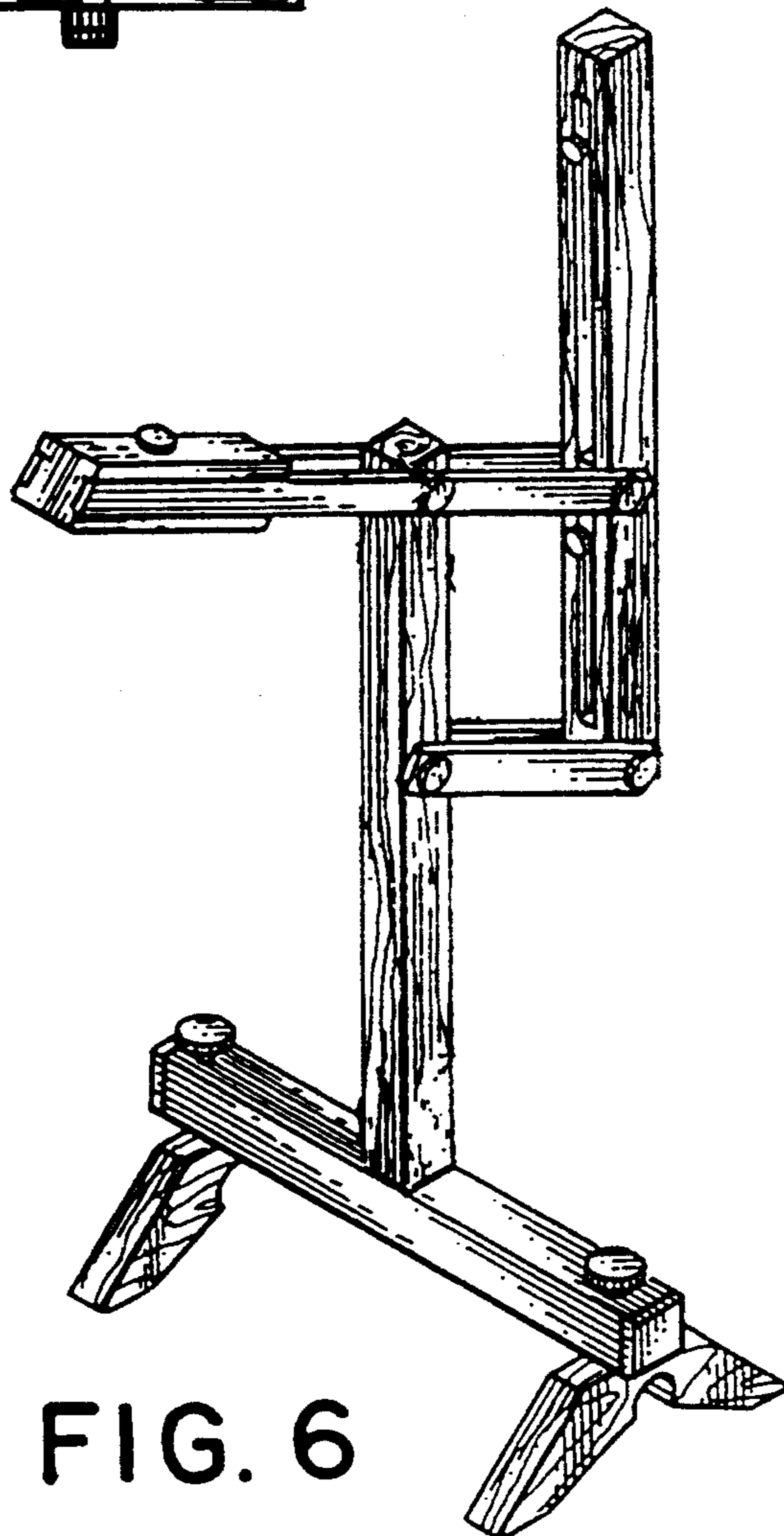
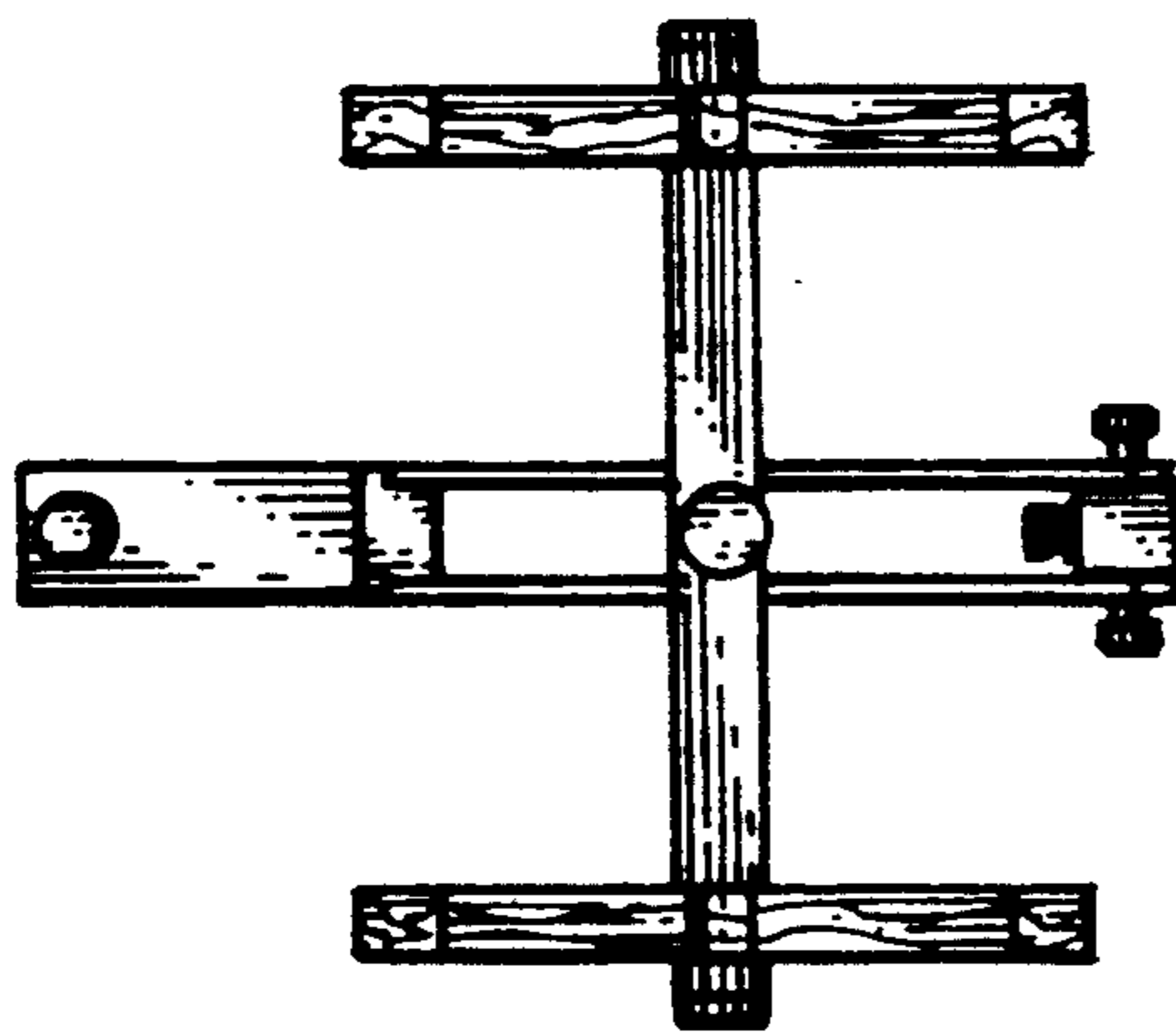

FIG. 6