



US00D349709S

United States Patent [19]

[11] Patent Number: **Des. 349,709**

Dair et al.

[45] Date of Patent: **** Aug. 16, 1994**

[54] **COMMUNICATIONS WORKSTATION**

[75] Inventors: **Thomas M. Dair**, Valley Cottage, N.Y.; **Daniel J. Formosa**, Montvale, N.J.; **Stuart H. Lee**, New York, N.Y.

[73] Assignee: **V Band Corporation**, Elmsford, N.Y.

[**] Term: **14 Years**

[21] Appl. No.: **11,285**

[22] Filed: **Jul. 30, 1993**

[52] U.S. Cl. **D14/241; D14/106**

[58] Field of Search 379/58-61, 379/419, 420, 428, 440, 441; 364/708.1, 709.4; D14/100, 101, 106, 113, 114, 115, 130, 149, 137, 140, 142, 240, 241; D18/7

[56] **References Cited**

U.S. PATENT DOCUMENTS

- D. 294,250 2/1988 Watanabe et al. D14/130
- D. 295,874 5/1988 Maladra et al. D14/100 X
- D. 302,974 8/1989 Shim D14/106
- D. 303,113 8/1989 Danielson et al. D14/106
- D. 303,946 10/1989 Ditzik D14/106
- D. 310,518 9/1990 Dezes D14/106

- D. 324,036 2/1992 Warasa D14/101
- D. 332,943 2/1993 Koiwa et al. D14/100 X
- D. 334,179 3/1993 Crafoord D14/100
- D. 335,654 5/1993 Robinson et al. D14/100

Primary Examiner—Alan P. Douglas
Assistant Examiner—Jeffrey Asch
Attorney, Agent, or Firm—Parmelee, Bollinger & Bramblett

[57] **CLAIM**

The ornamental design for the communications workstation, as shown and described.

DESCRIPTION

FIG. 1 is a top view of a communications workstation showing our new design;
 FIG. 2 is a front elevational view of FIG. 1;
 FIG. 3 is a right side elevational view of FIG. 1;
 FIG. 4 is a left side elevational view of FIG. 1;
 FIG. 5 is a rear view of FIG. 1;
 FIG. 6 is a bottom view of FIG. 1; and,
 FIG. 7 is a perspective view of FIG. 1 showing the keyboard detached from the control unit of the communications workstation.
 The cord, shown broken away for convenience of illustration in FIGS. 1, 3, 6 and 7, is continuous throughout.

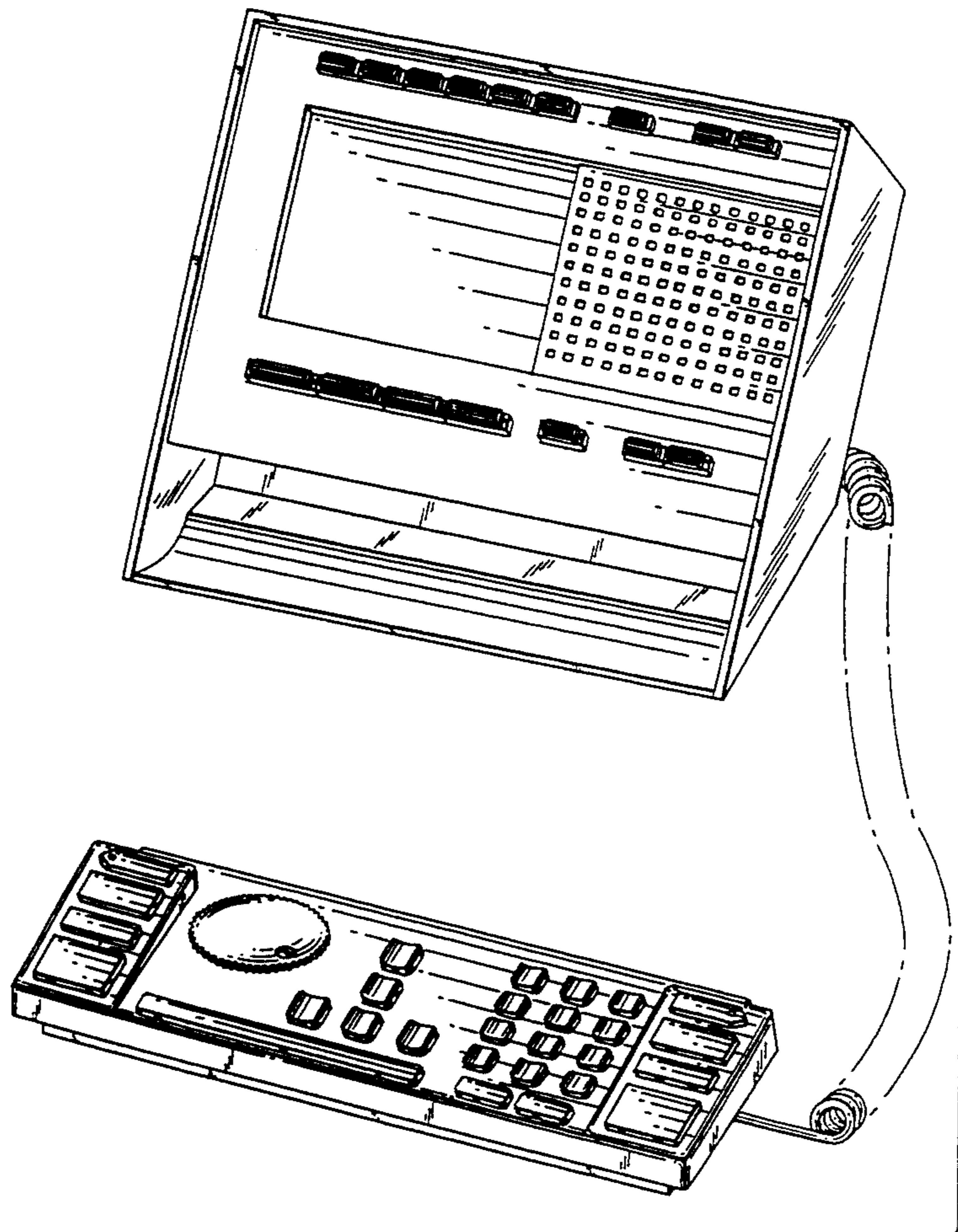

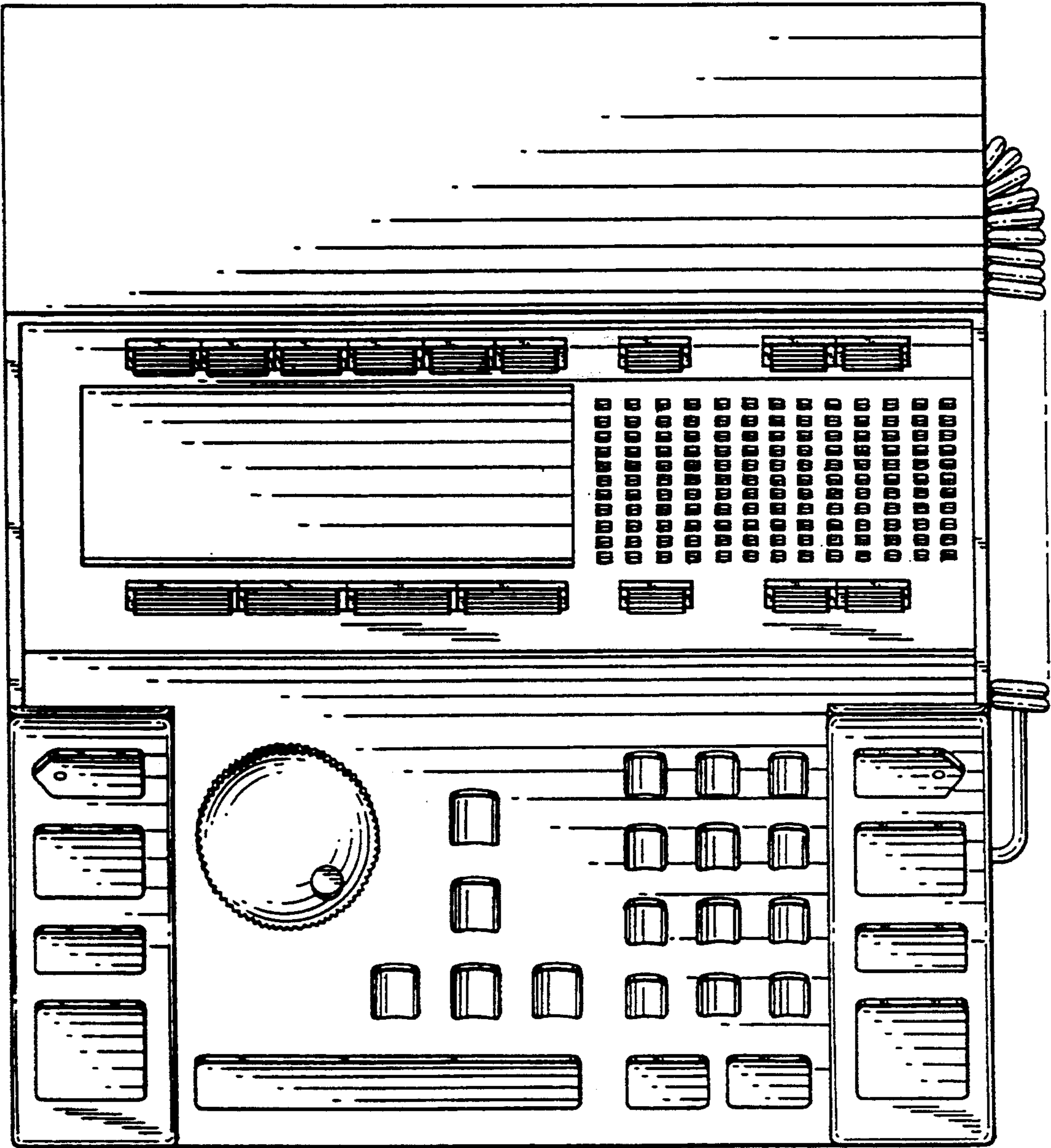

FIG. 1

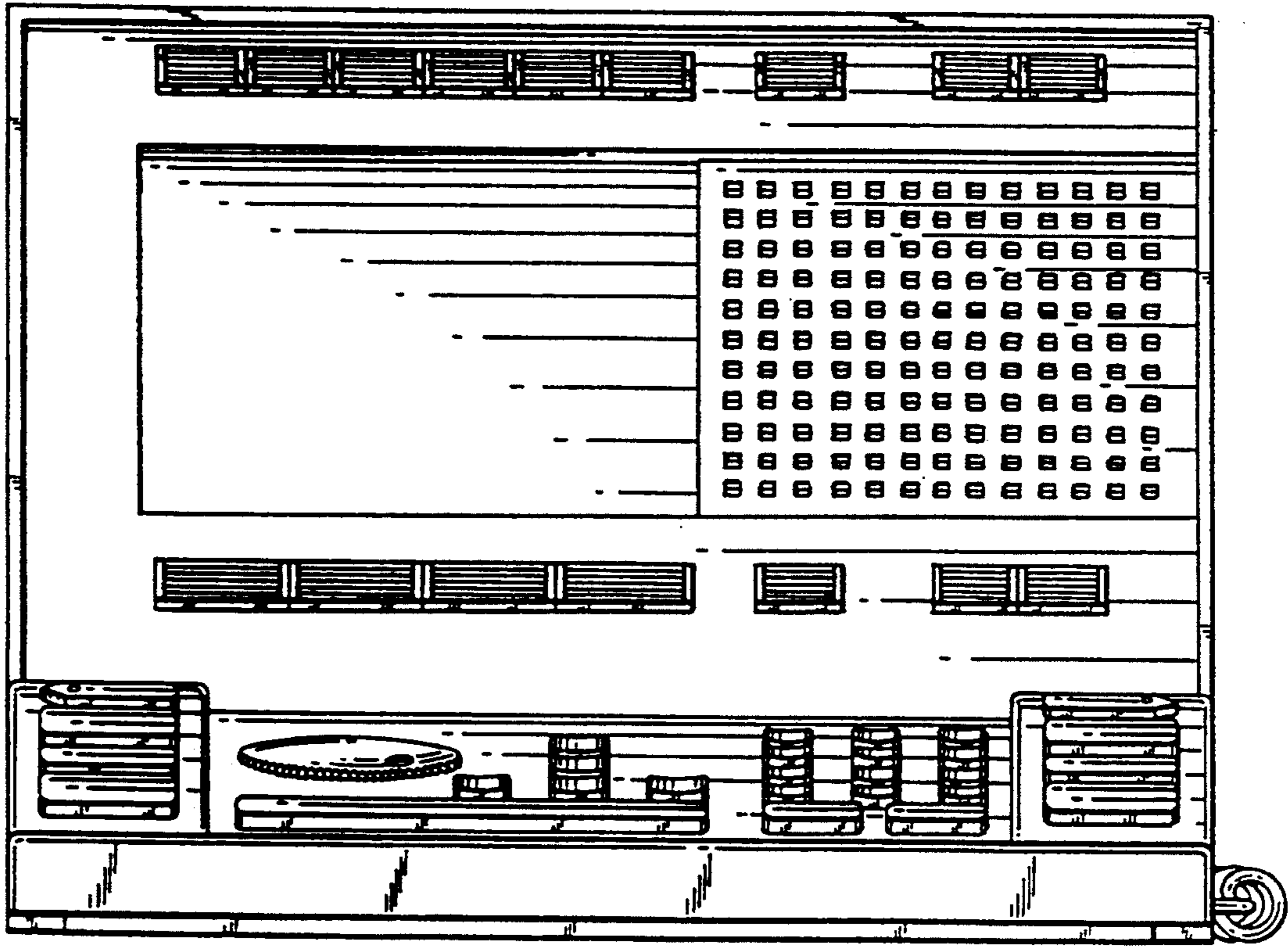

FIG. 2

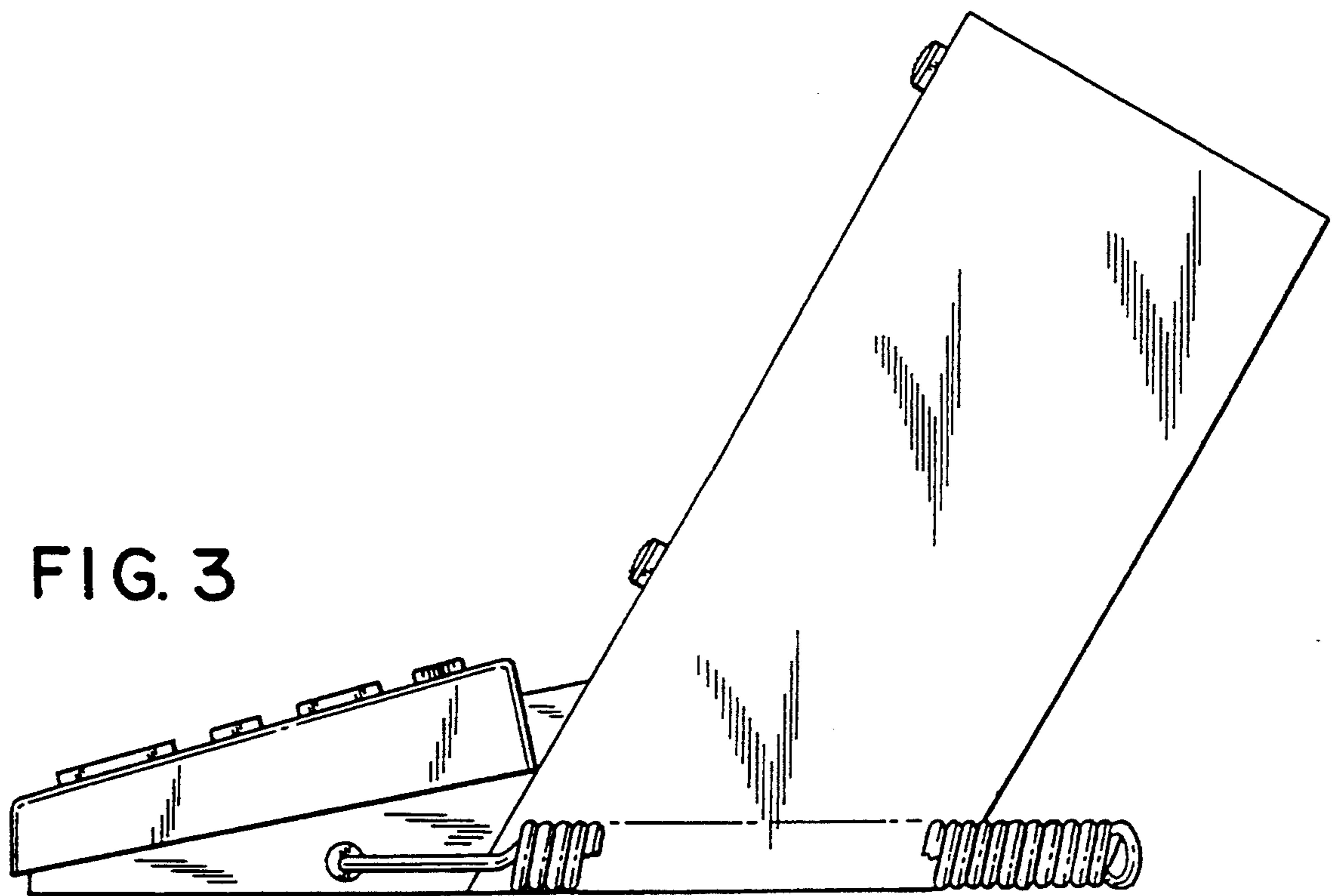

FIG. 3

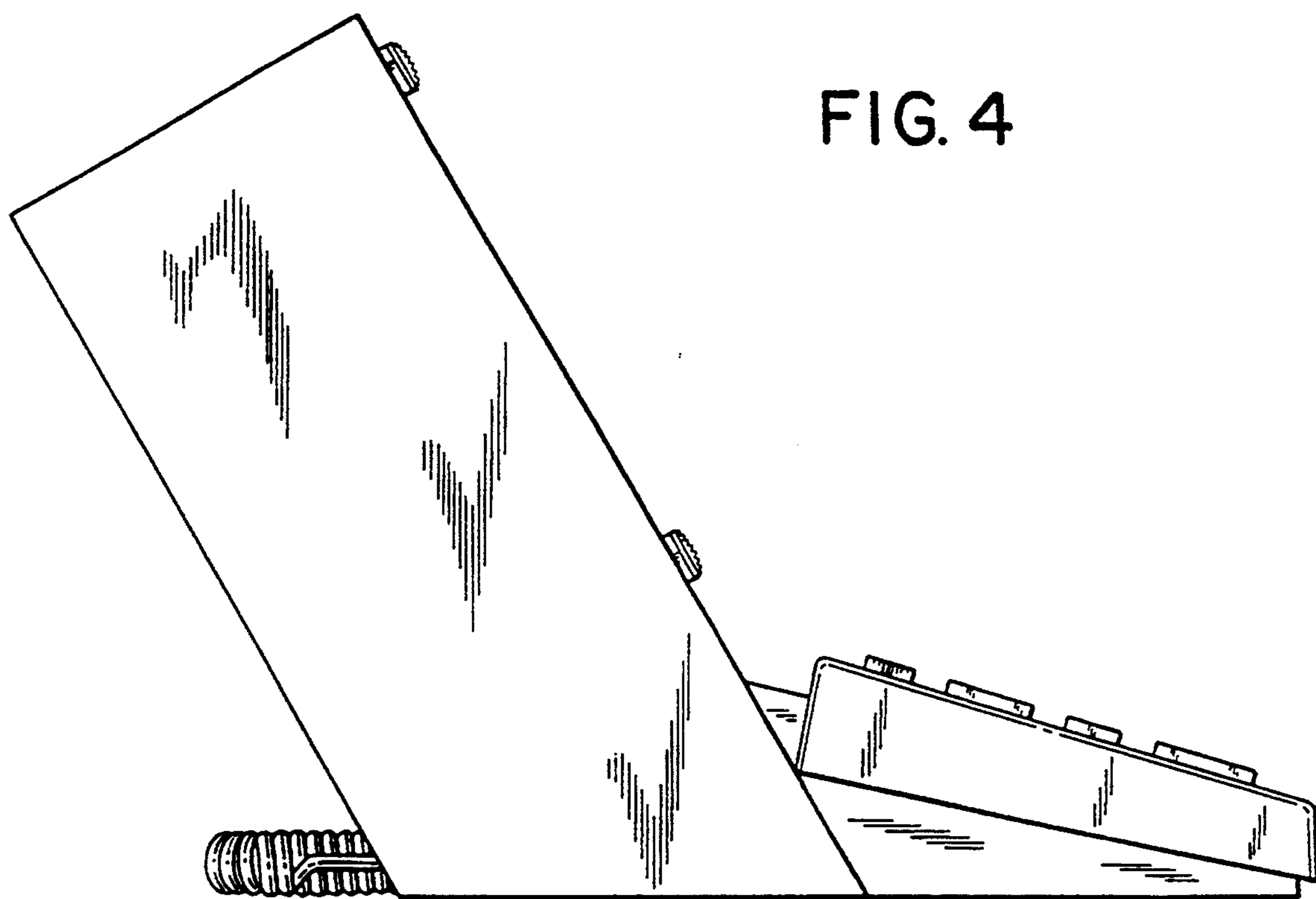
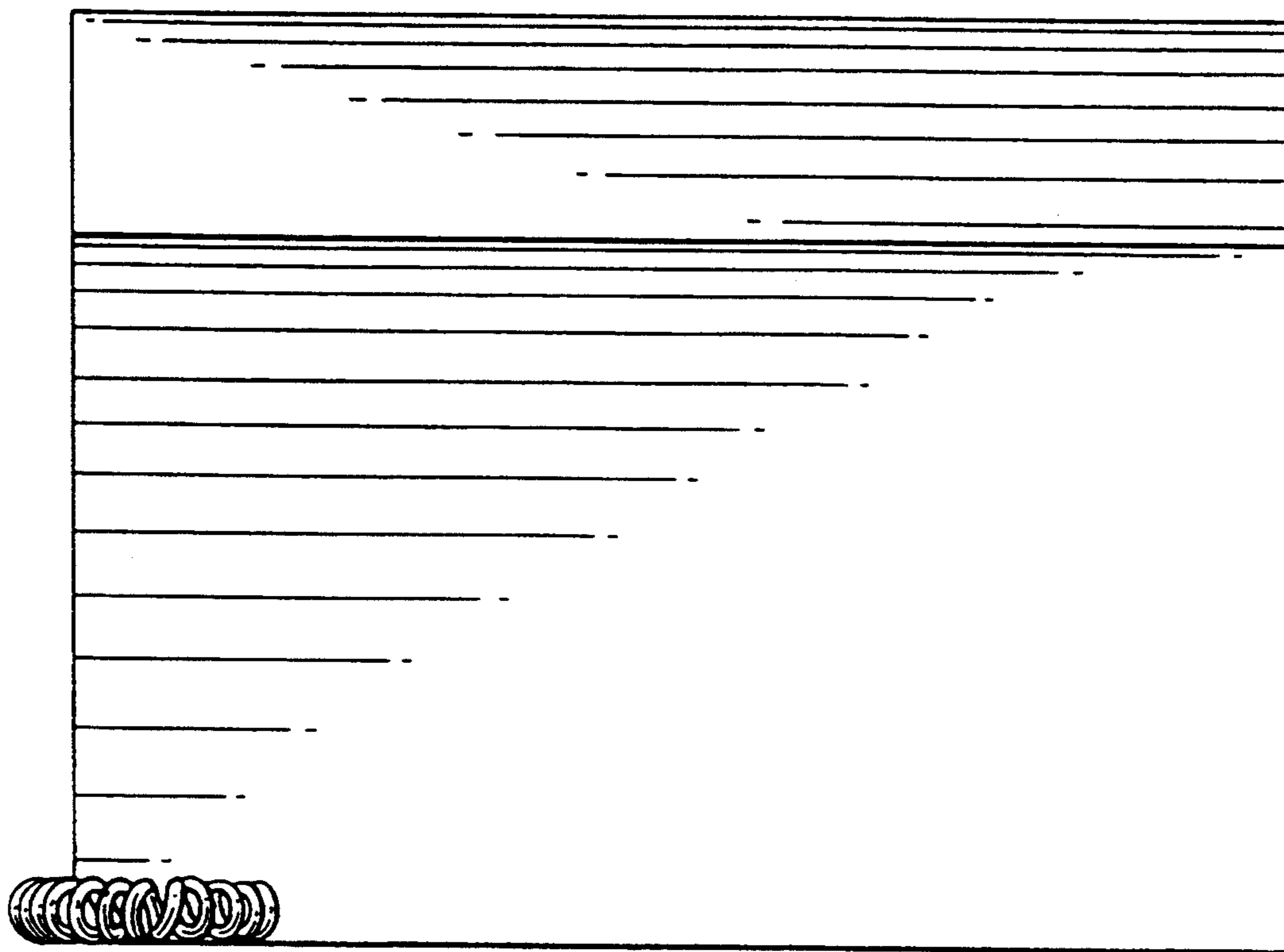

FIG. 4

FIG. 5



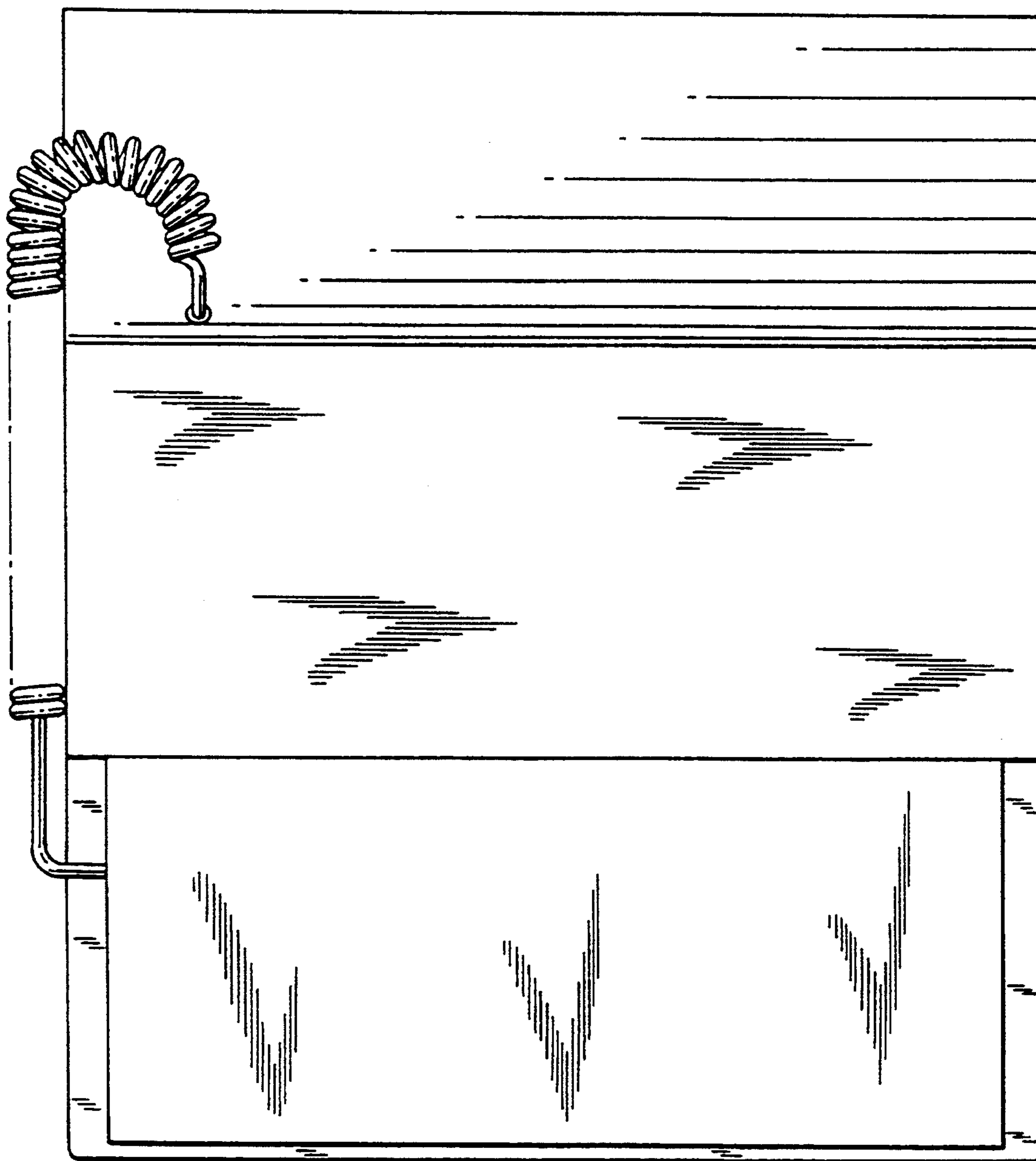

FIG. 6

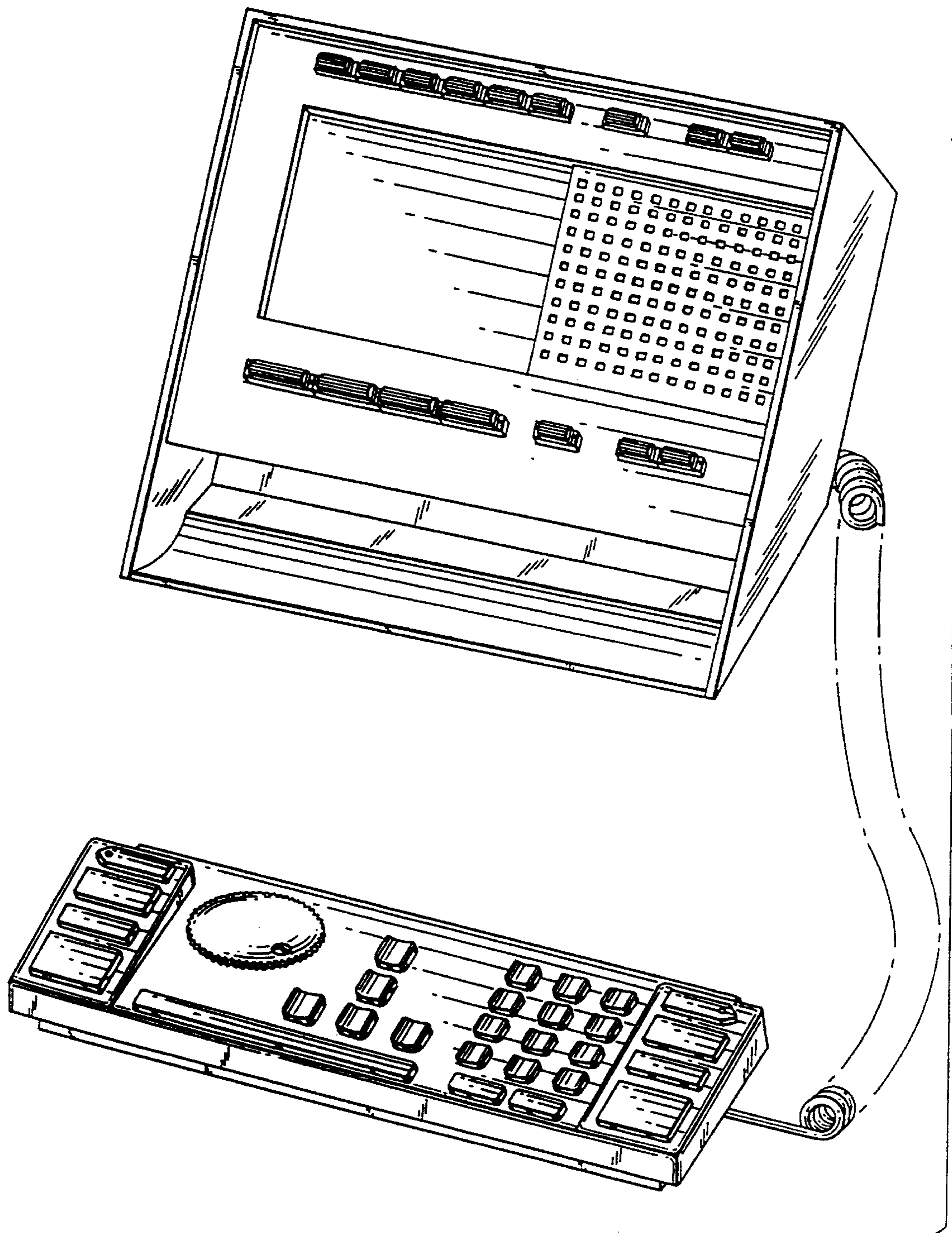

FIG. 7