



US00D349700S

# United States Patent [19]

[11] Patent Number: Des. 349,700

Iseli et al.

[45] Date of Patent: \*\* Aug. 16, 1994

## [54] TELEPHONE WITH A HOLDER

[75] Inventors: **Martin Iseli**, Bern; **Christine Emmert**, Solothurn; **Hans-Rudolf Reber**, Günsberg, all of Switzerland

[73] Assignee: **Bang & Ollufsen Holding A/S**, Stuer, Denmark

[\*\*] Term: **14 Years**

[21] Appl. No.: **10,651**

[22] Filed: **Jun. 21, 1993**

### Related U.S. Application Data

[63] Continuation of Ser. No. 775,242, Oct. 10, 1991, abandoned.

### [30] Foreign Application Priority Data

Jun. 17, 1991 [DK] Denmark ..... MA 0632 1991

[52] U.S. Cl. .... D14/142; D14/148

[58] Field of Search ..... 379/420, 368, 428, 433, 379/434, 436, 432, 419, 421, 440, 454; D14/140, 138, 141, 142, 148, 149, 150, 151, 240, 241, 248, 251, 253

### [56] References Cited

#### U.S. PATENT DOCUMENTS

D. 275,008	8/1984	Martin	.....	D14/151
D. 279,981	8/1985	Tsukamoto et al.	.....	D14/138
D. 291,692	9/1987	Read et al.	.....	D14/253
D. 297,009	8/1988	Grambush et al.	.....	D14/138
D. 299,342	1/1989	Buchin	.....	D14/241 X
D. 319,828	9/1991	Thomke	.....	D14/142
D. 332,450	1/1993	Kolinen	.....	D14/151

## OTHER PUBLICATIONS

Museum of Modern Art 1987 Christmas Catalog, p. 38, Becker Phone #3079.

The Shelburne Co. Holiday 1983 catalog, Electra Clock Radio Phone, p. 15.

Advertisement—Jydsk Telefon Aktieselskab Sletvej 4, Aarhus Denmark (1991).

*Primary Examiner*—Alan P. Douglas

*Assistant Examiner*—Jeffrey Asch

*Attorney, Agent, or Firm*—Darby & Darby

## [57] CLAIM

The ornamental design for a telephone with a holder, as shown and described.

## DESCRIPTION

FIG. 1 is a top perspective view of a telephone with a holder showing our new design;

FIG. 2 is a front elevational view thereof;

FIG. 3 is a rear elevational view thereof;

FIG. 4 is a left side elevational view thereof;

FIG. 5 is a right side elevational view thereof;

FIG. 6 is a bottom plan view thereof;

FIG. 7 is a top plan view thereof;

FIG. 8 is a top perspective view of the receiver;

FIG. 9 is a front elevational view thereof;

FIG. 10 is a side elevational view thereof, the other side being identical;

FIG. 11 is a rear elevational view thereof;

FIG. 12 is a bottom plan view thereof;

FIG. 13 is a top plan view thereof;

FIG. 14 is a top perspective view of the holder; and,

FIG. 15 is a top plan view thereof.

The phone cord has been shown broken away in FIGS. 1-7 and the receiver and holder have been shown separately in FIGS. 8-15 for convenience of illustration.

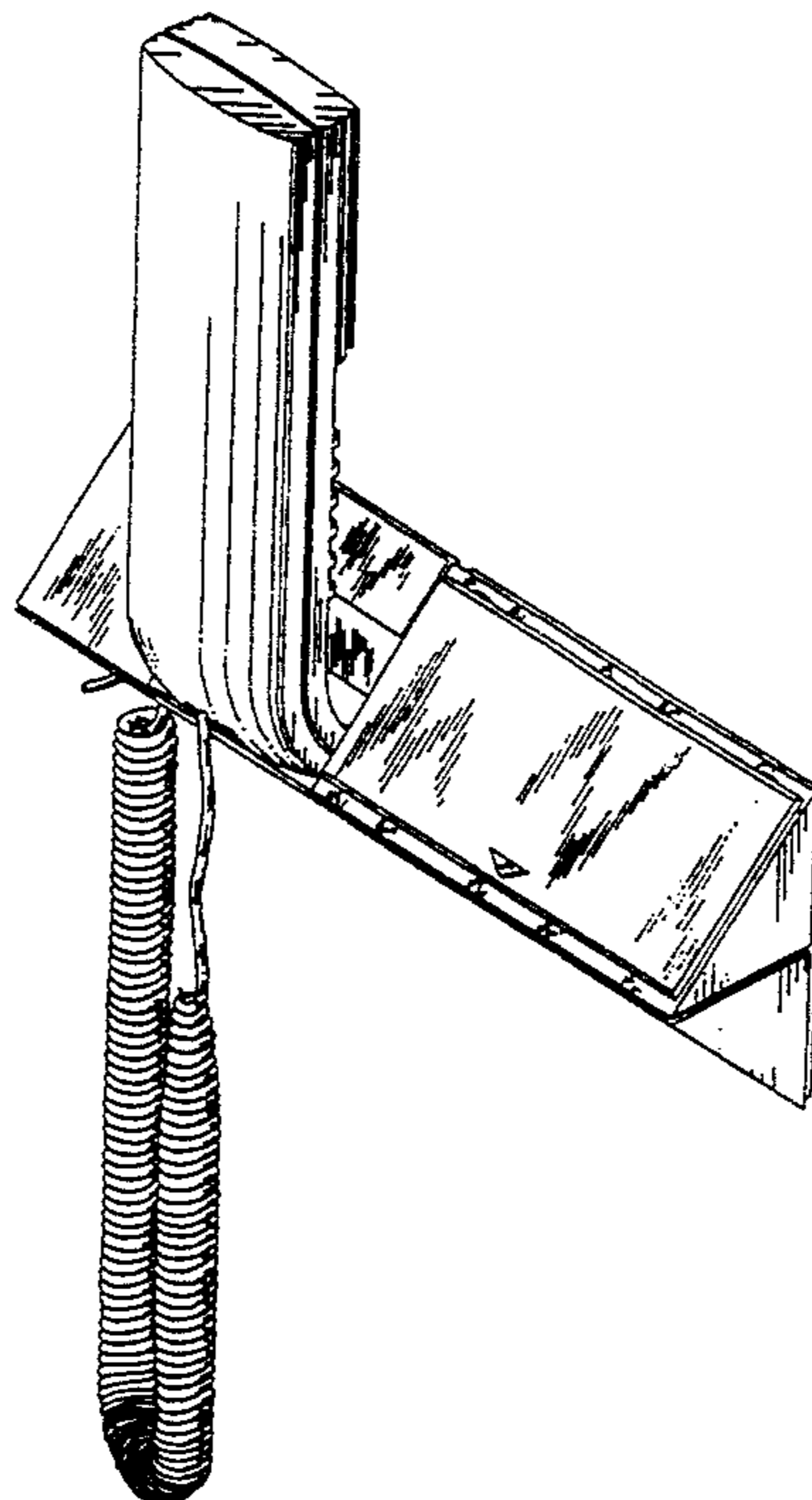

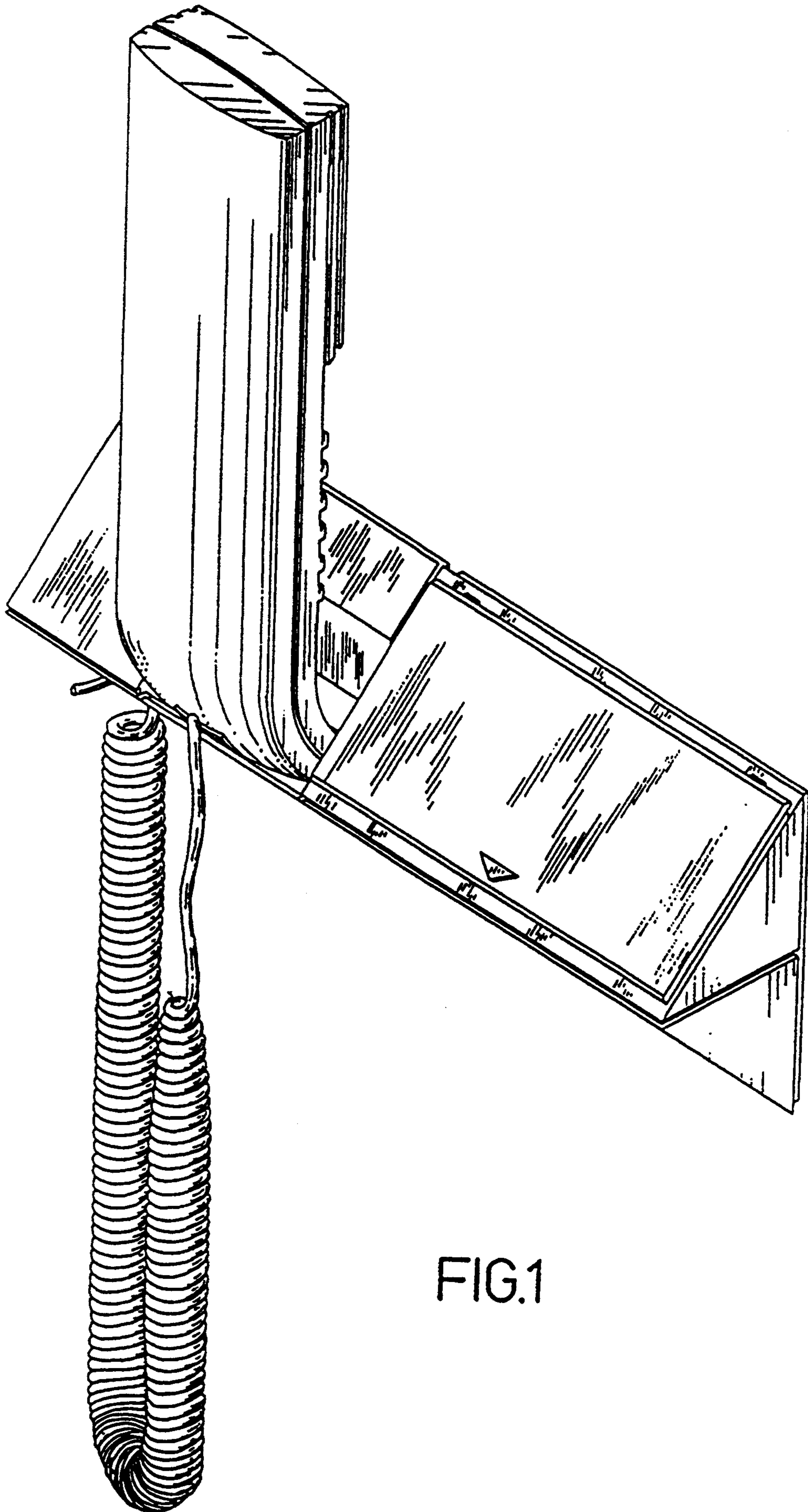

FIG.1

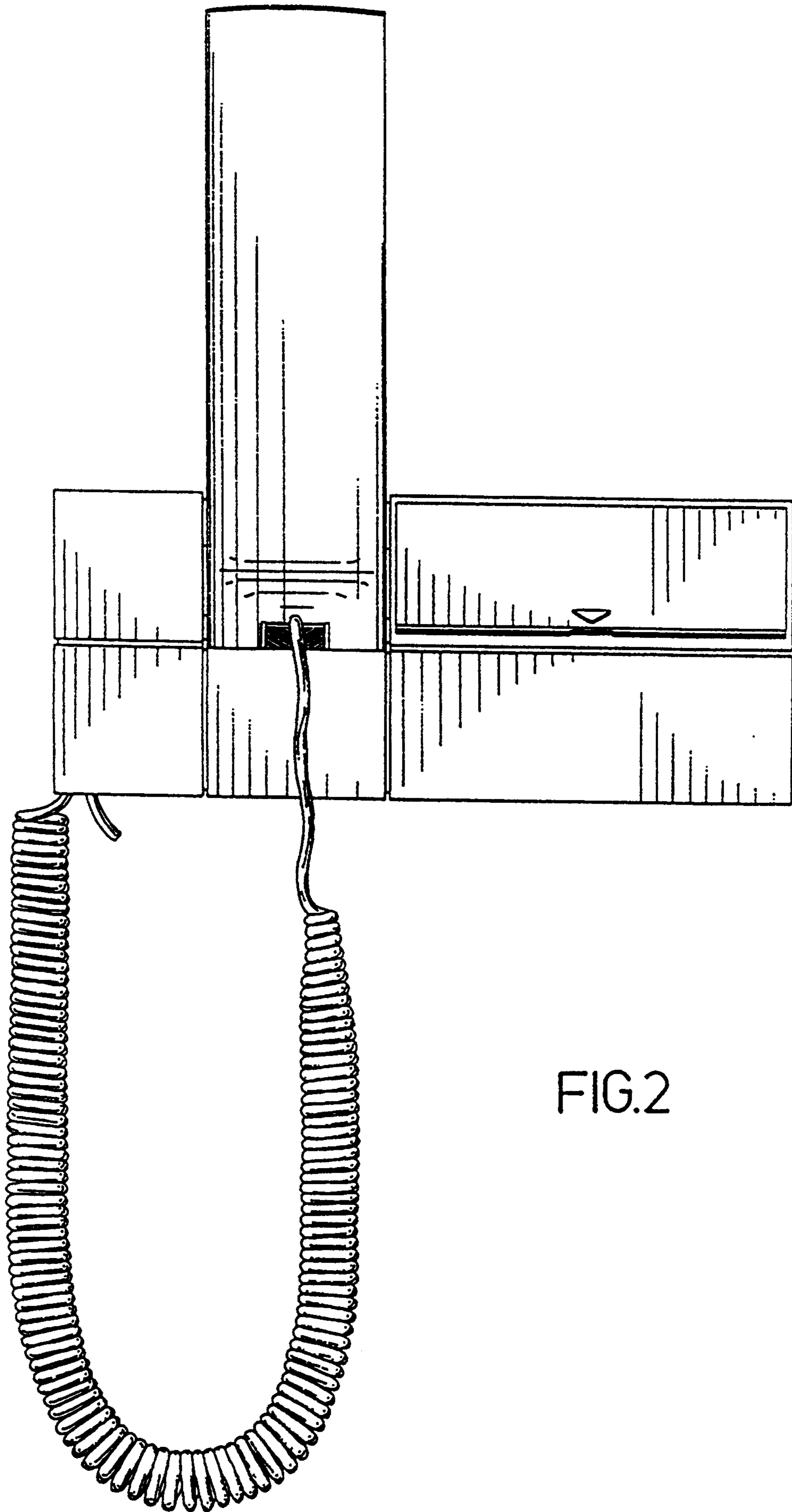

FIG.2

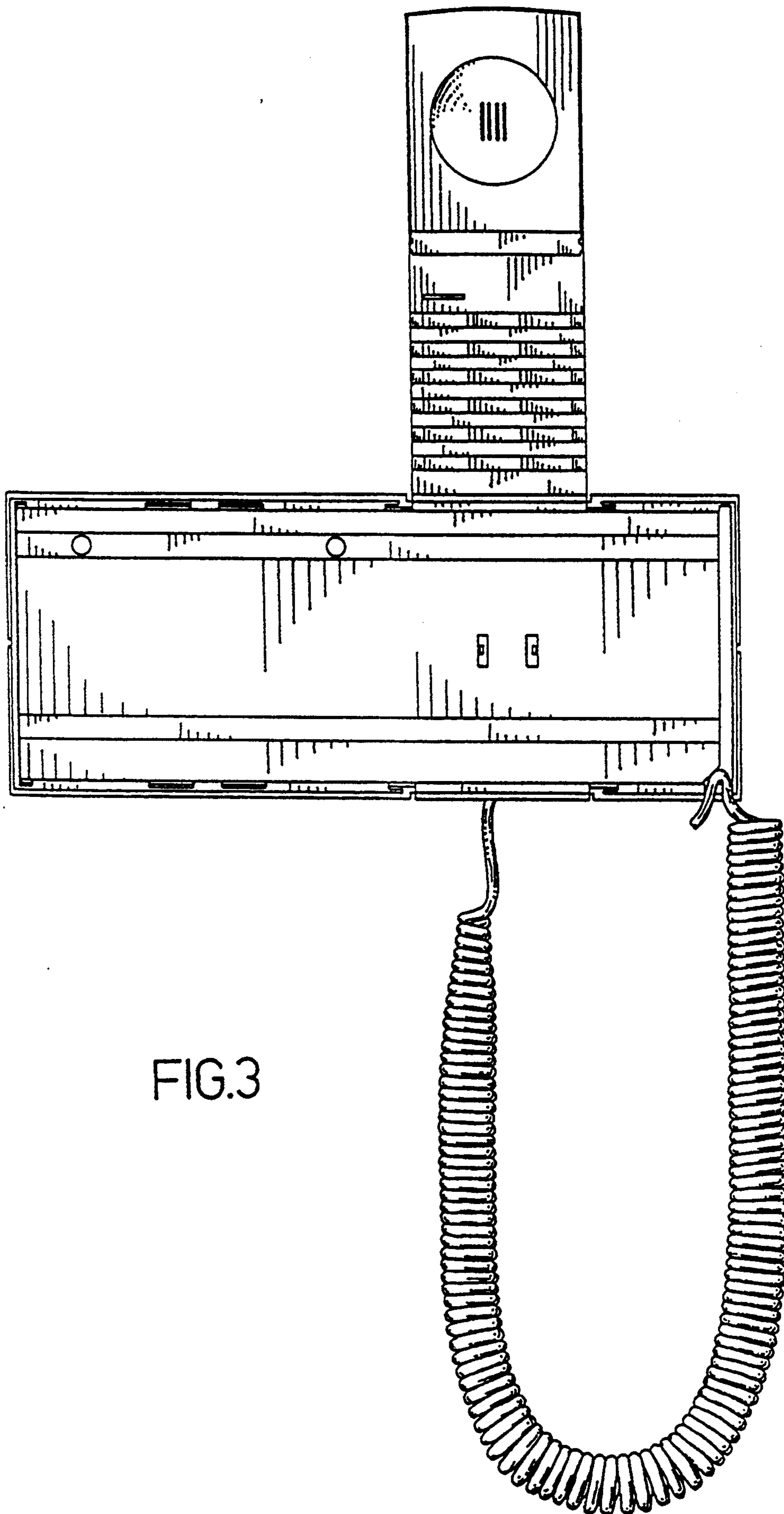

FIG.3

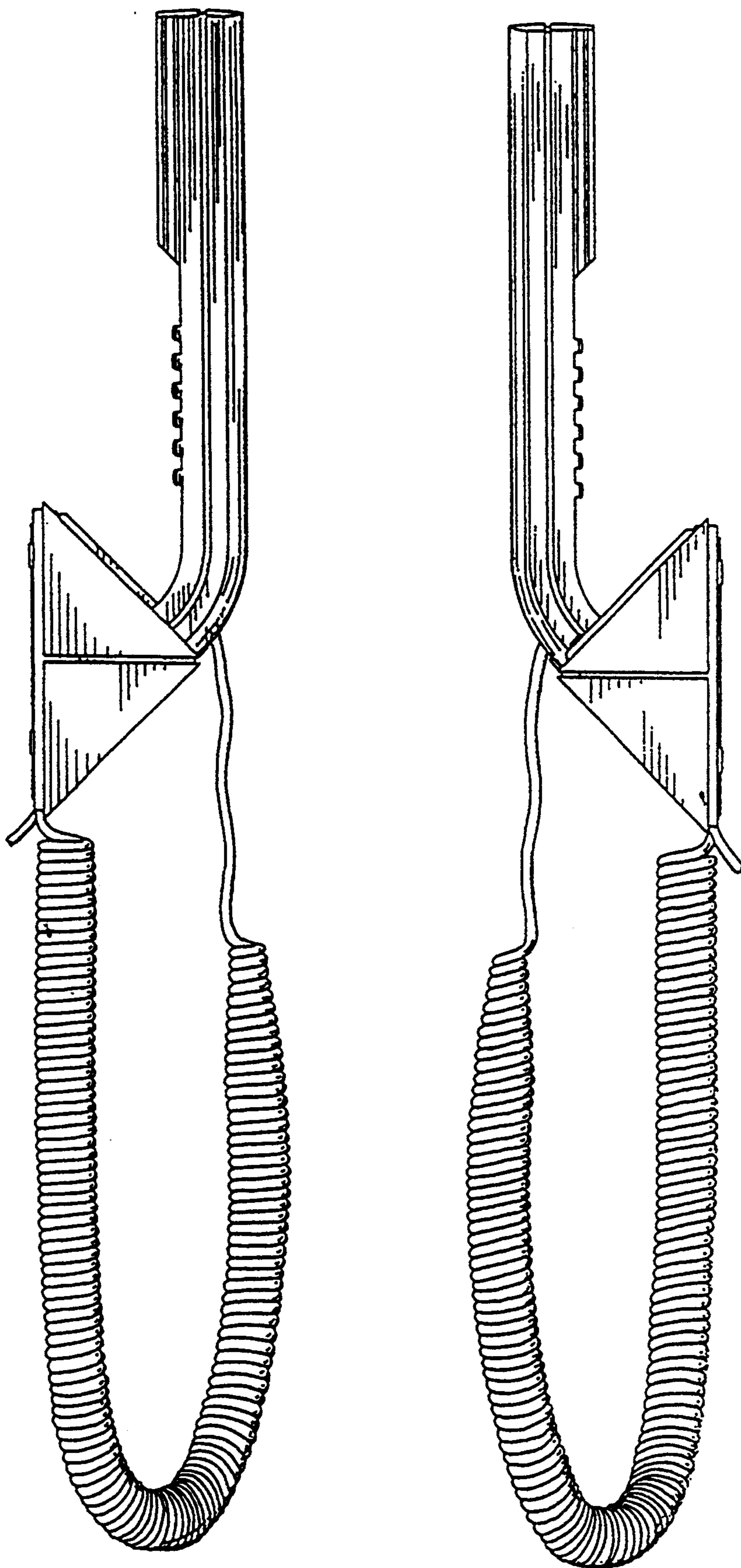

FIG.4

FIG.5

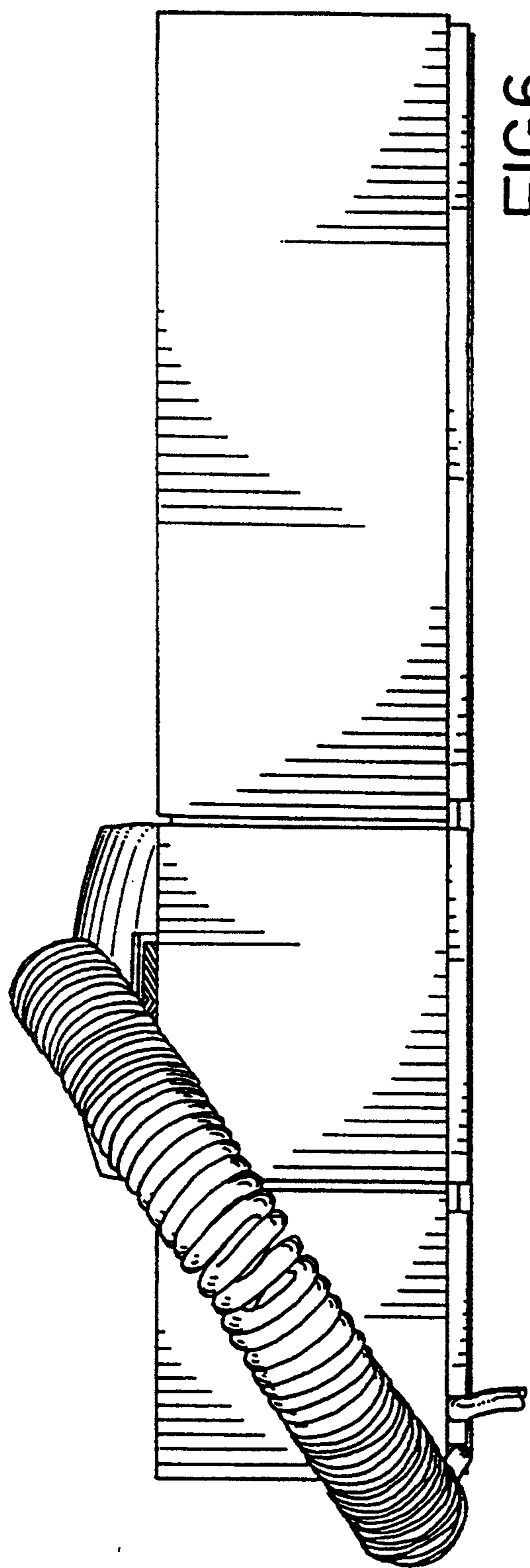

FIG. 6

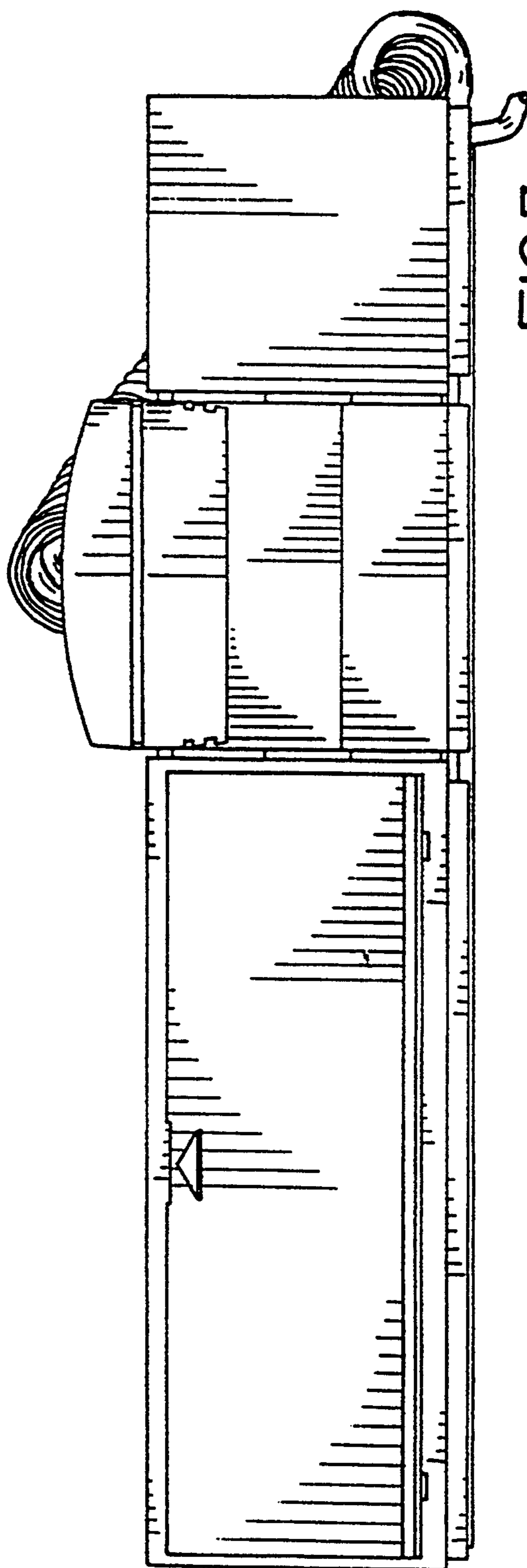

FIG. 7

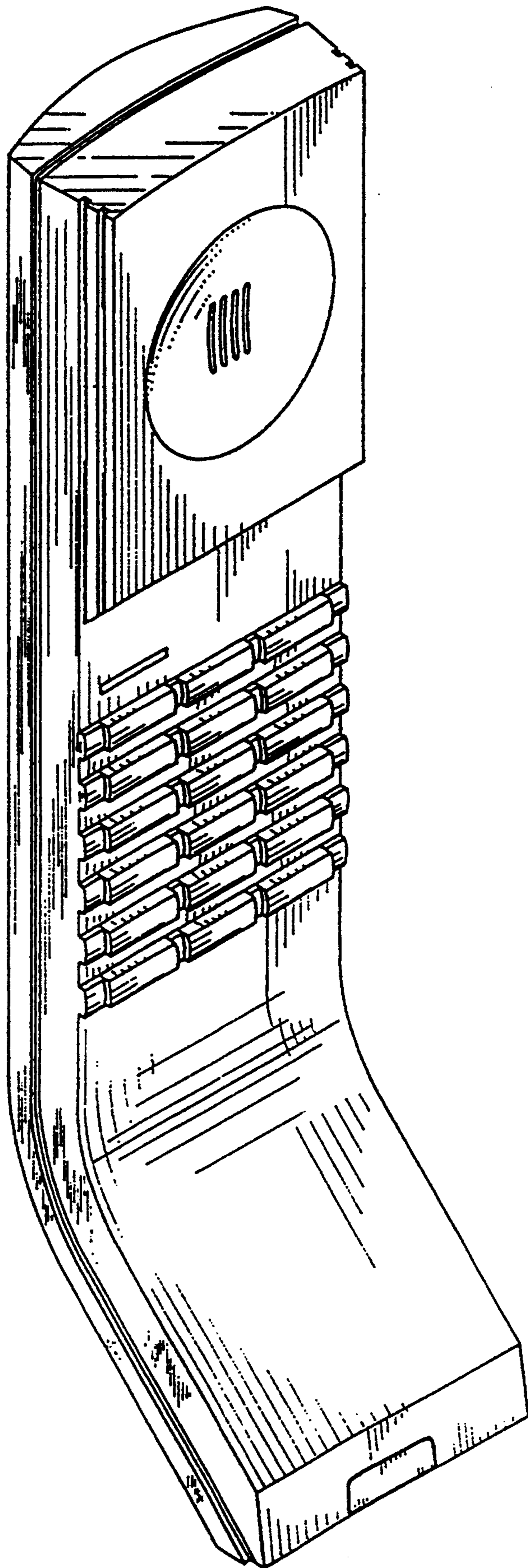

FIG.8

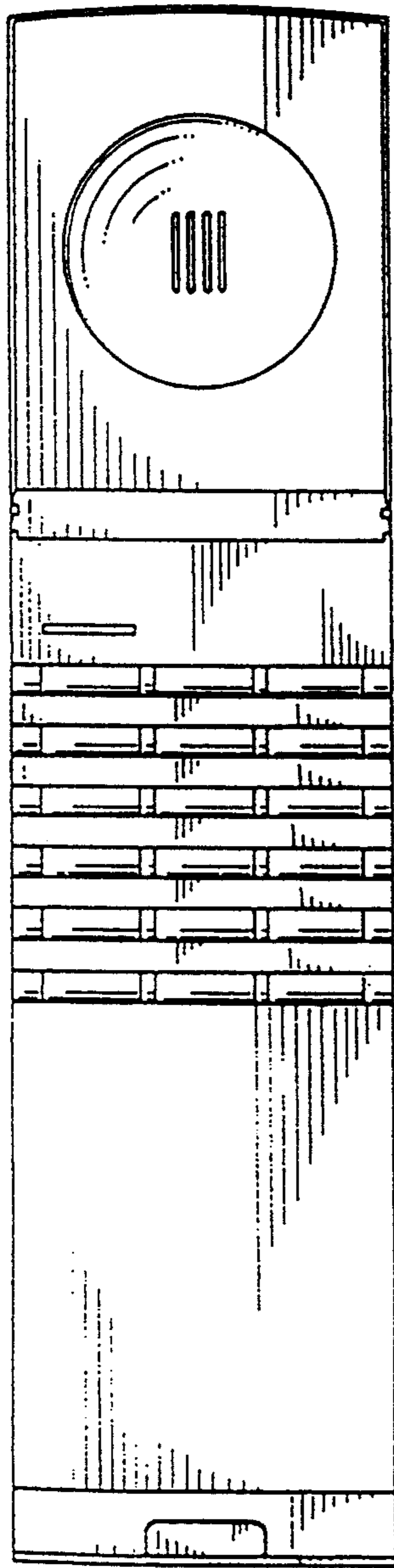

FIG.9

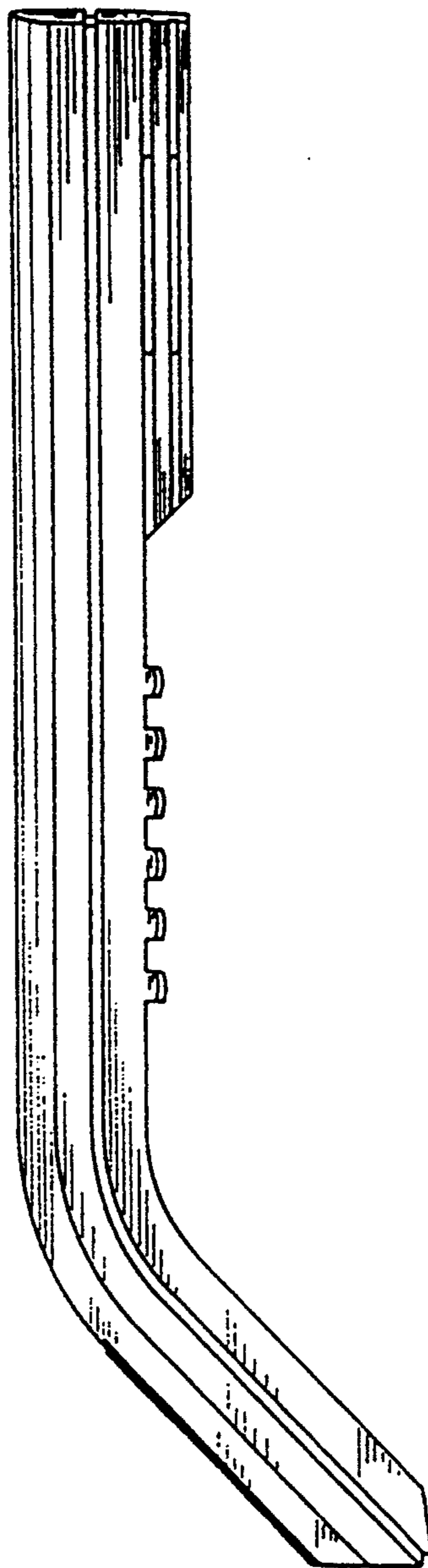

FIG.10

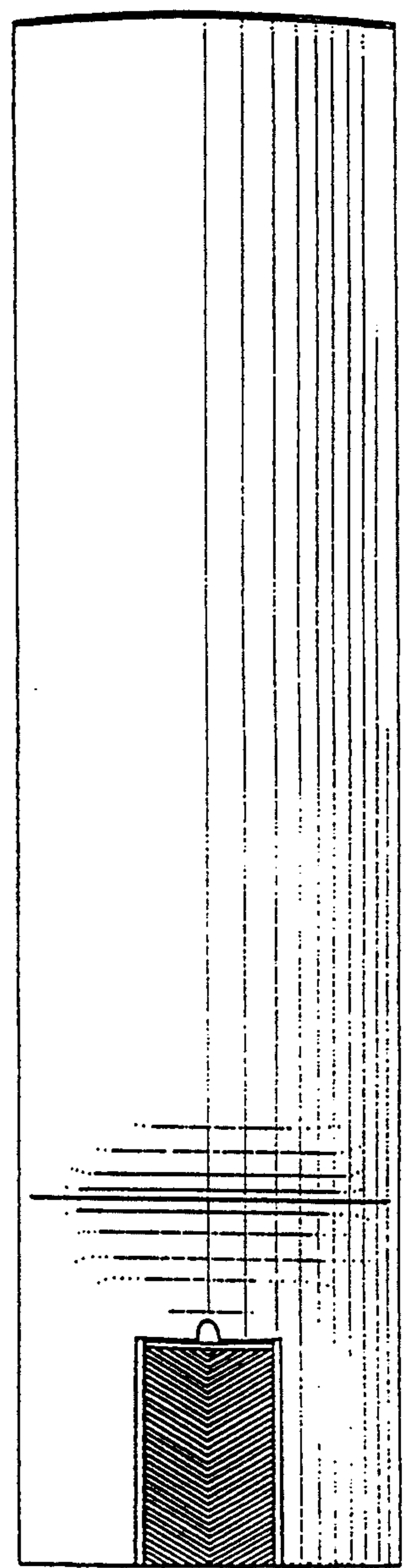

FIG.11



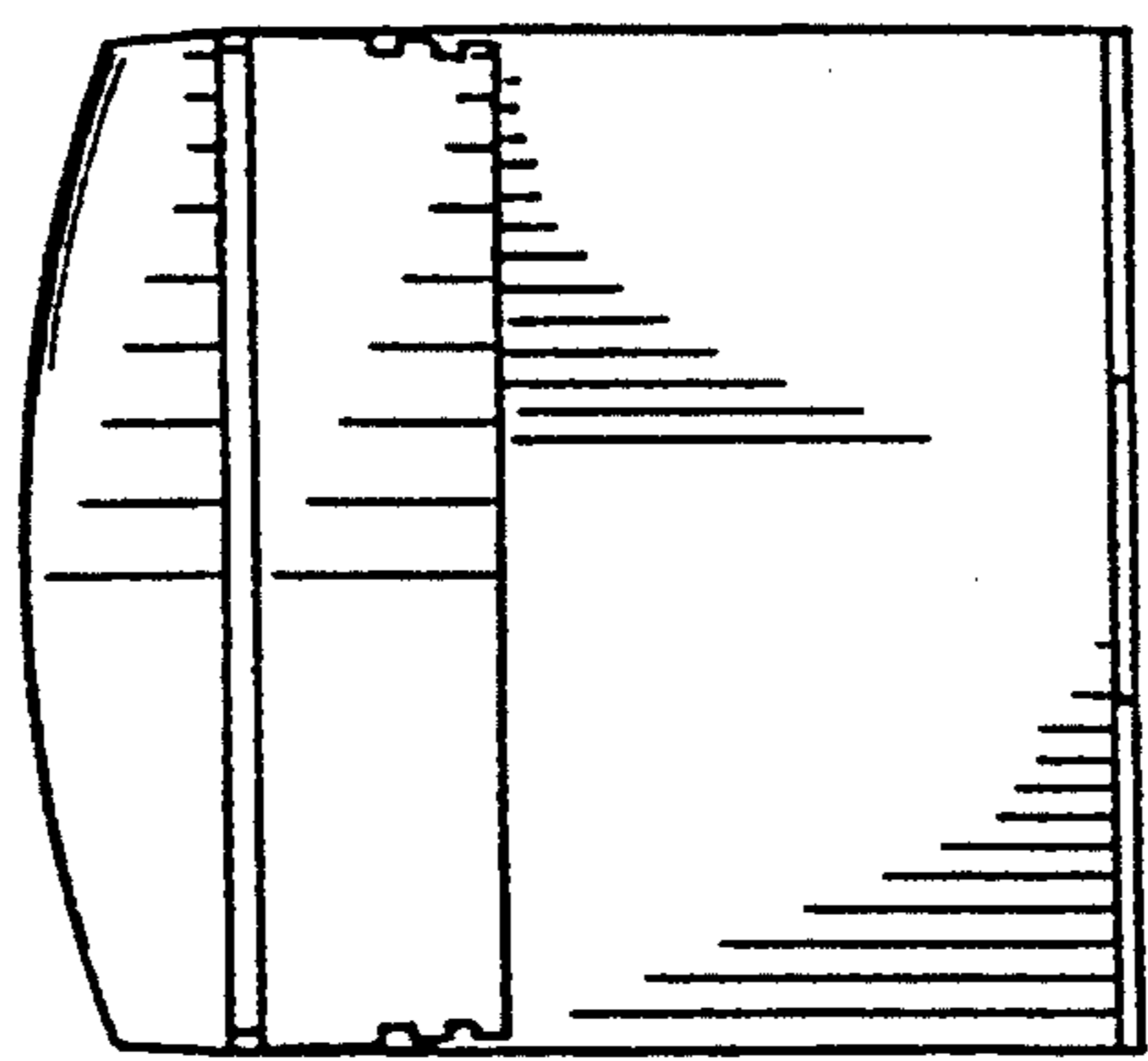

FIG.13

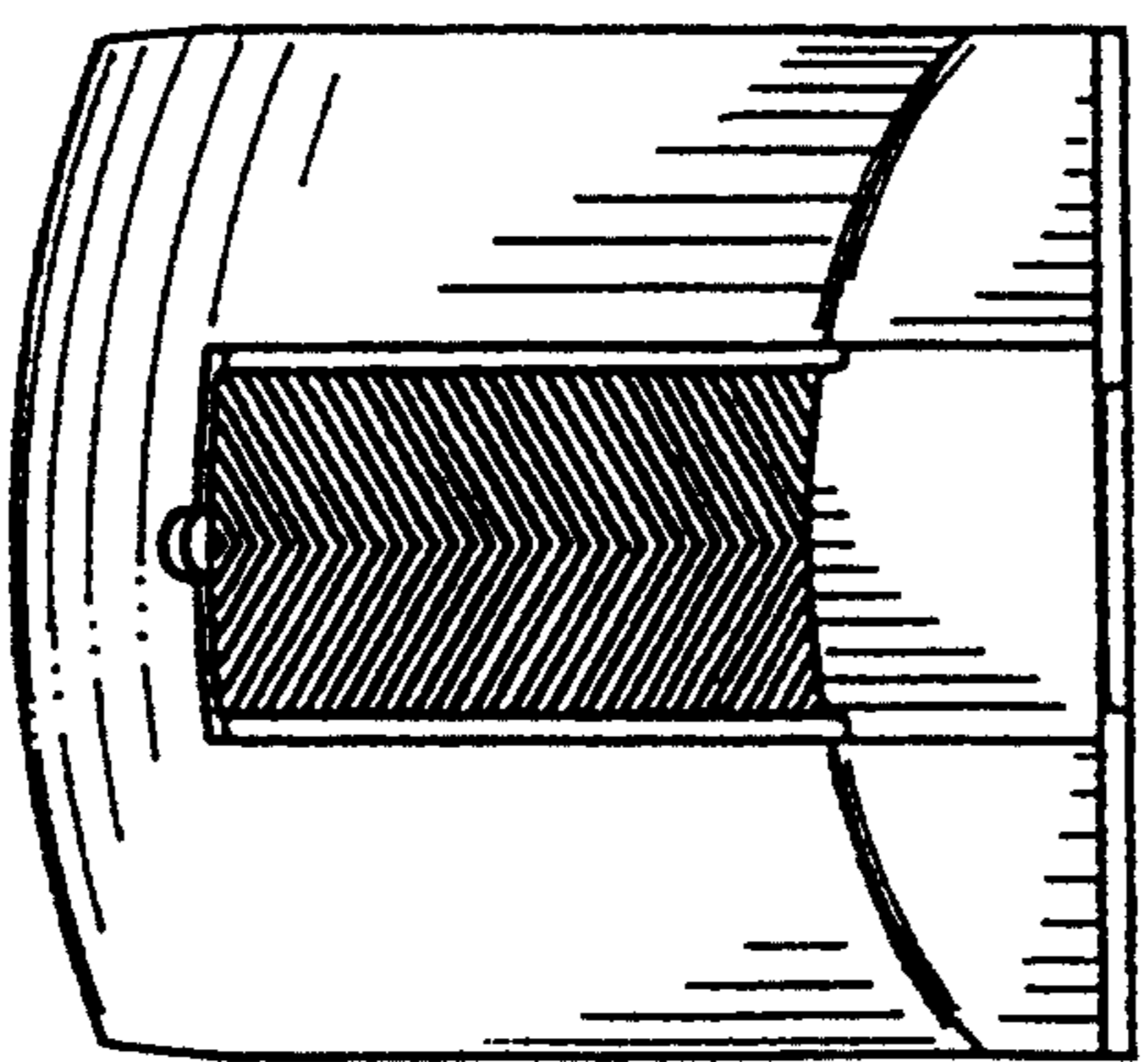

FIG.12

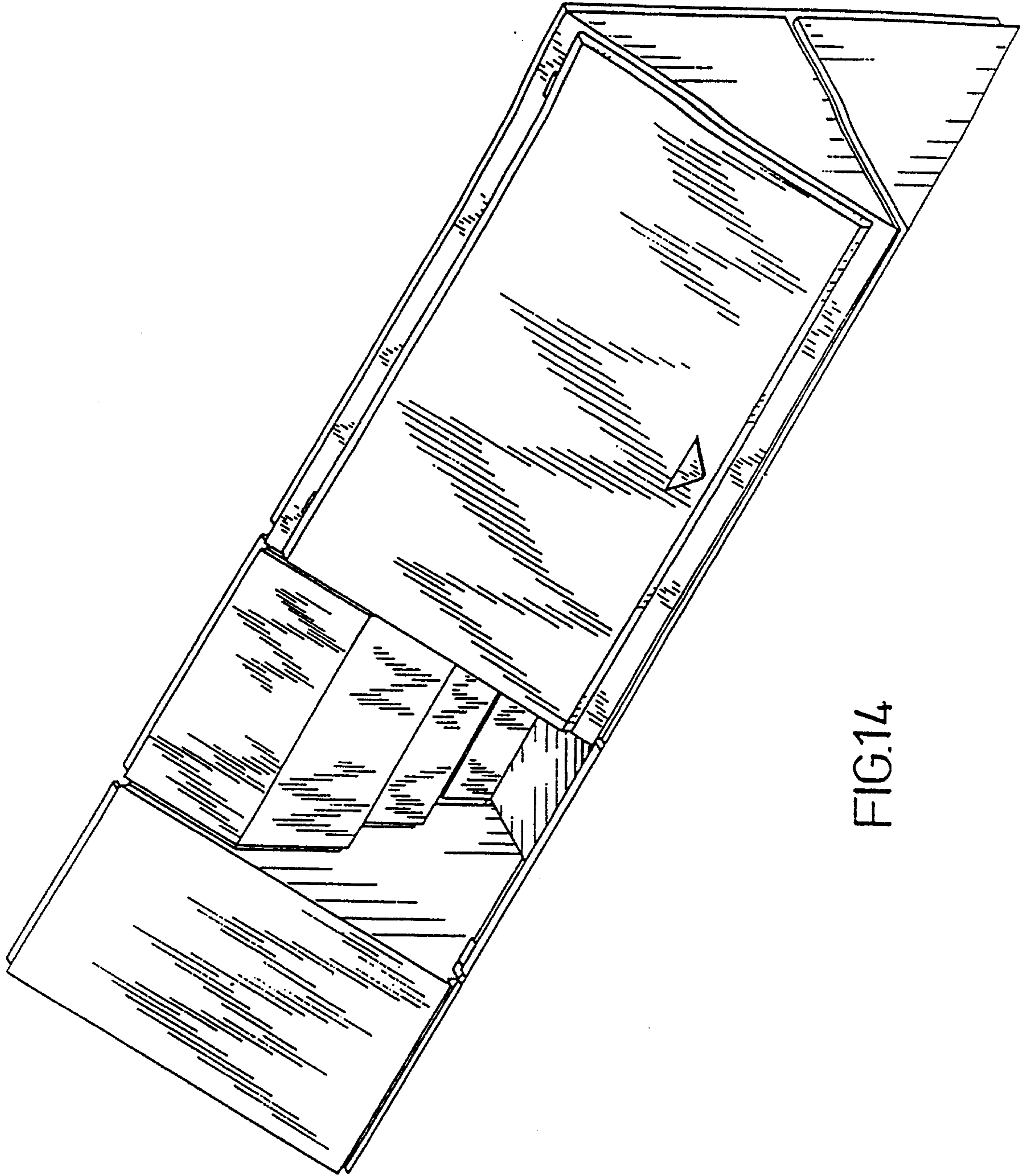

FIG.14

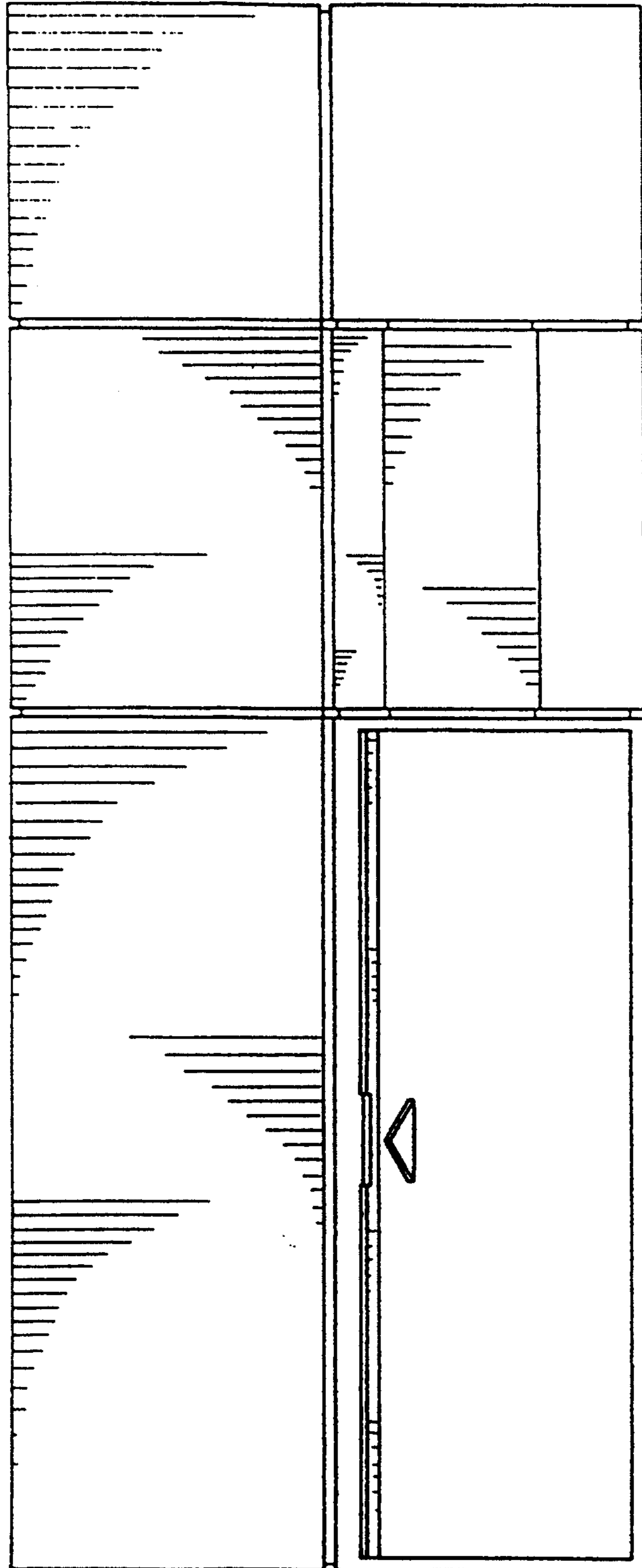

FIG.15