



US00D349632S

United States Patent [19]

[11] Patent Number: **Des. 349,632**

Nicholson et al.

[45] Date of Patent: **** Aug. 16, 1994**

[54] **COLLECTIBLE RACE CAR COOKIE JAR**

D. 328,690 8/1992 Roe D7/610
4,753,346 6/1988 Tsuji 206/457 X

[76] Inventors: **Linda Nicholson; Clarence Russell,**
both of Rte. 4 - Box 16, Clyde, N.C.
28721

Primary Examiner—Terry A. Wallace
Attorney, Agent, or Firm—Hugh E. Smith

[**] Term: **14 Years**

[57] **CLAIM**

[21] Appl. No.: **931,538**

The ornamental design for a collectible race car cookie jar, as shown and described.

[22] Filed: **Aug. 20, 1992**

DESCRIPTION

[52] U.S. Cl. **D7/613; D9/308;**
D21/136

FIG. 1 is a front elevational view of the collectible race car cookie jar showing my new design;
FIG. 2 is a rear elevational view thereof;
FIG. 3 is a left side elevational view thereof;
FIG. 4 is a right side elevational view thereof;
FIG. 5 is a top plan view thereof;
FIG. 6 is a bottom plan view thereof; and,
FIG. 7 is an exploded front view thereof.

[58] **Field of Search** **D7/612-614;**
D9/307, 308; 220/457; D21/128, 136, 137

[56] **References Cited**

U.S. PATENT DOCUMENTS

D. 301,266 5/1989 Ishizawa D21/136 X

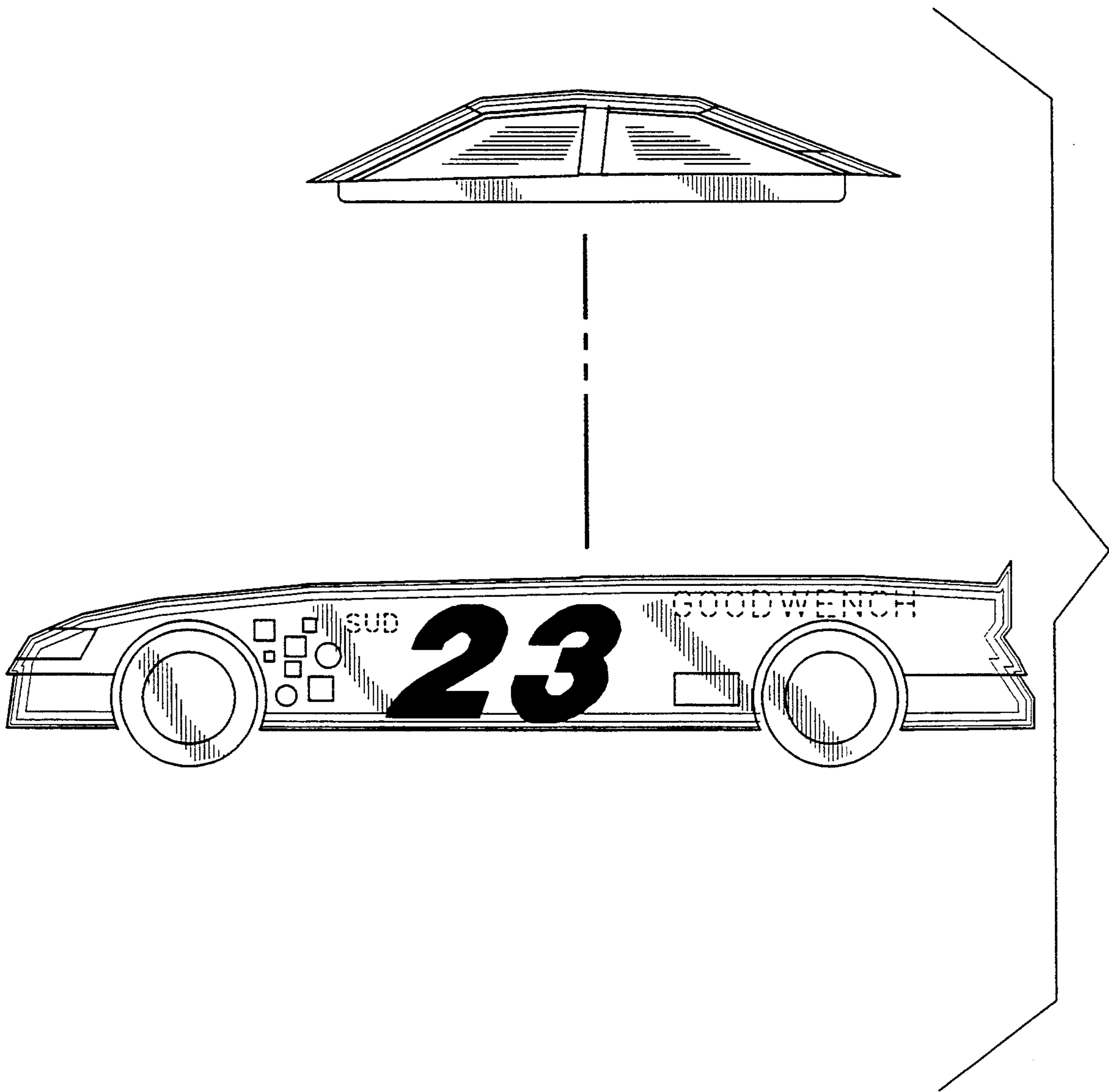

FIG. 1

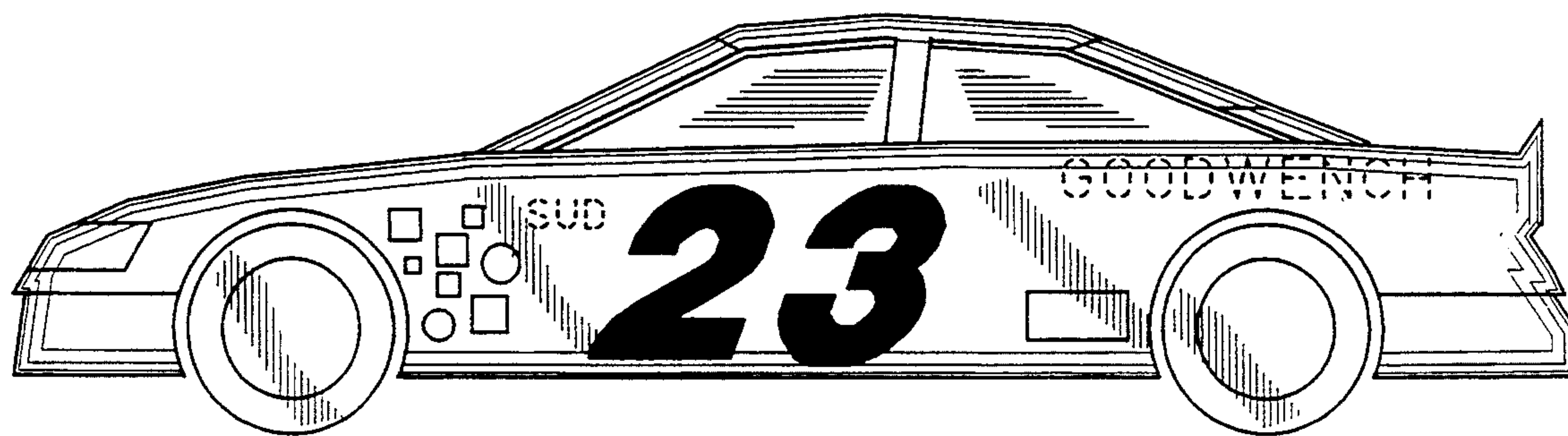

FIG. 2

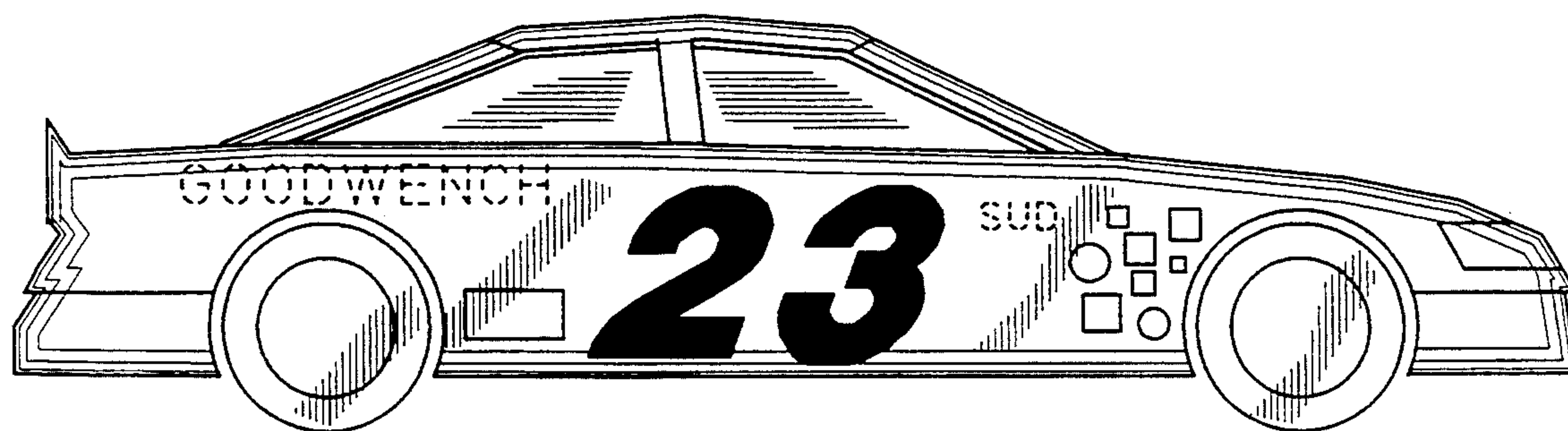

FIG. 3

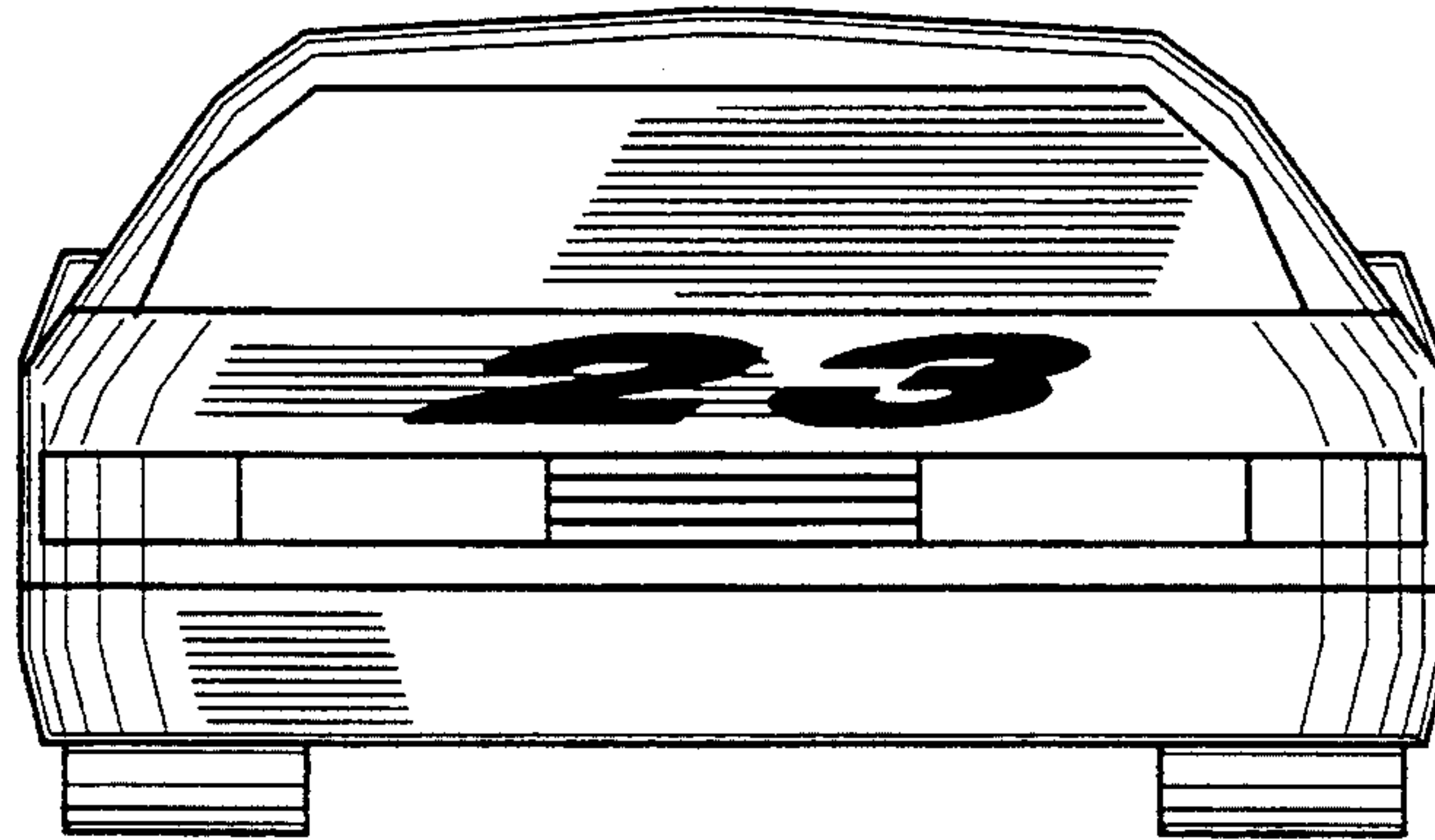

FIG. 4

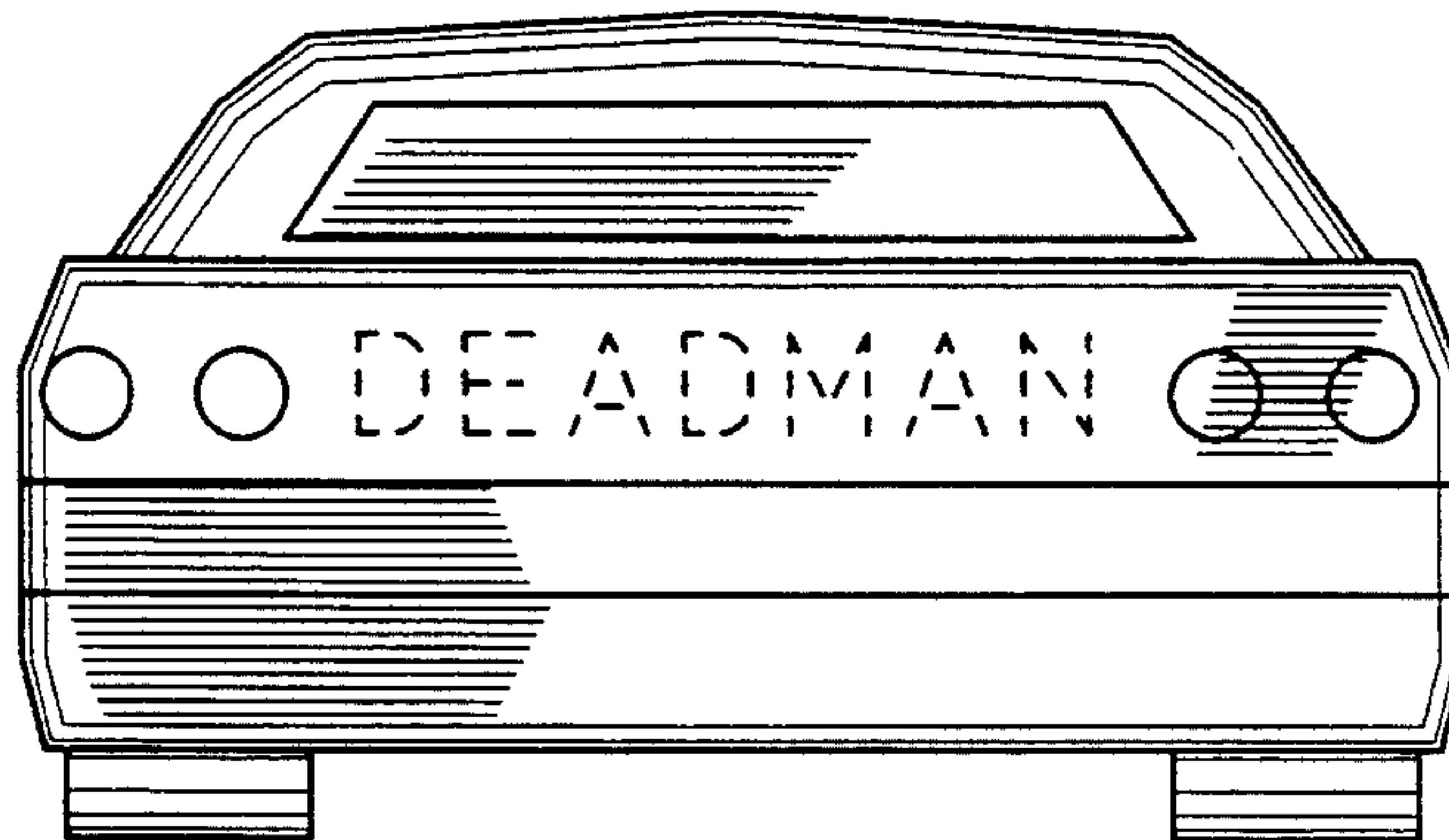

FIG. 5

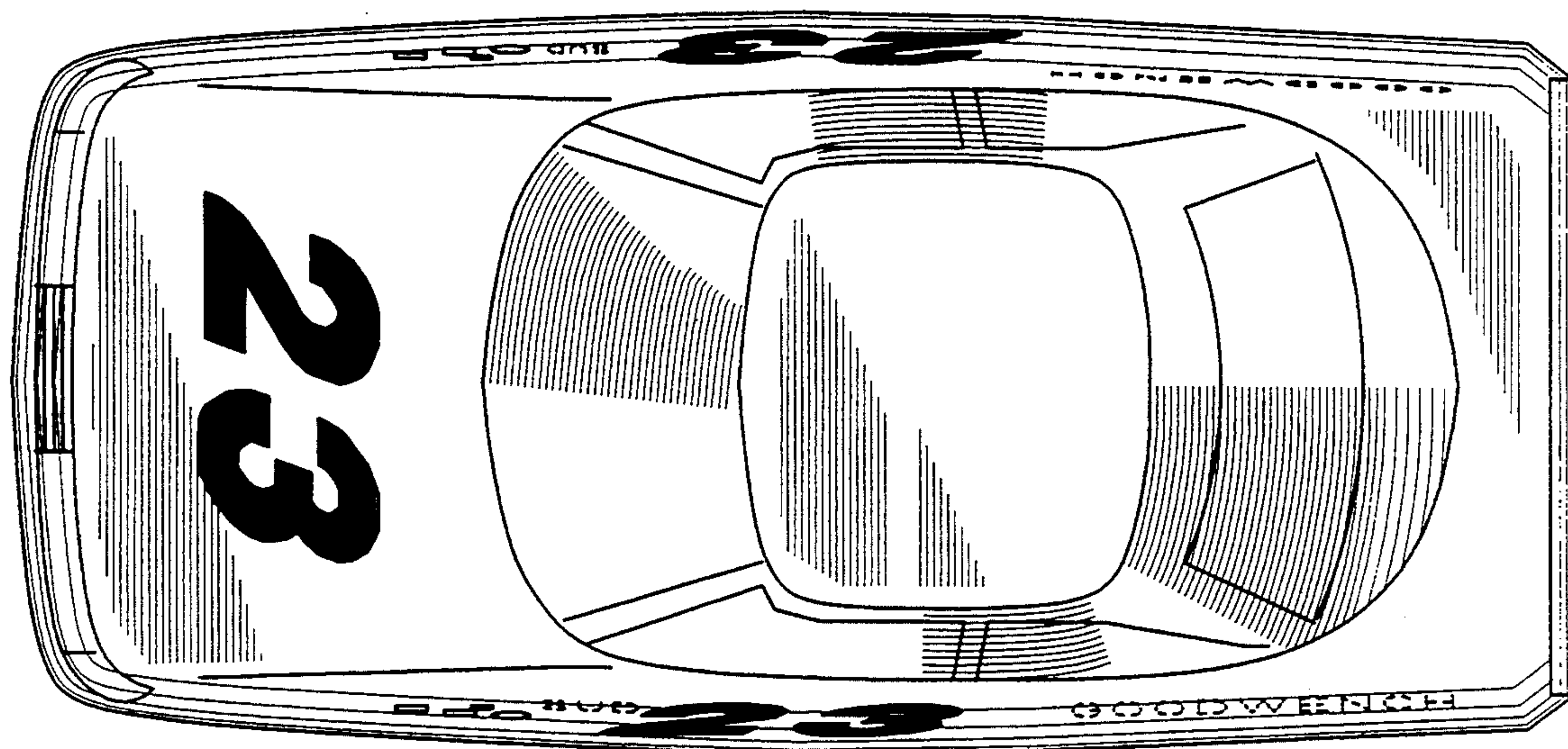
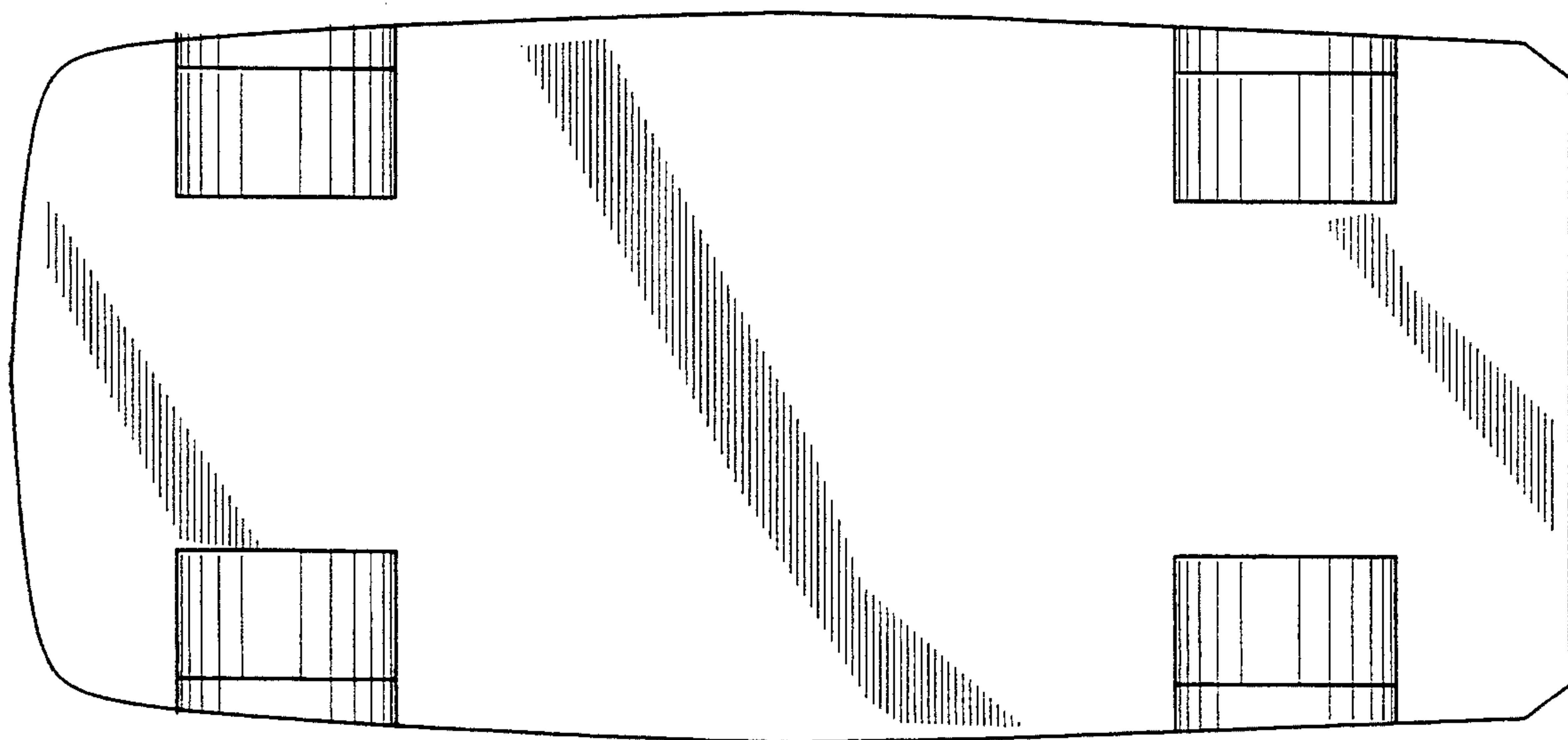

FIG. 6



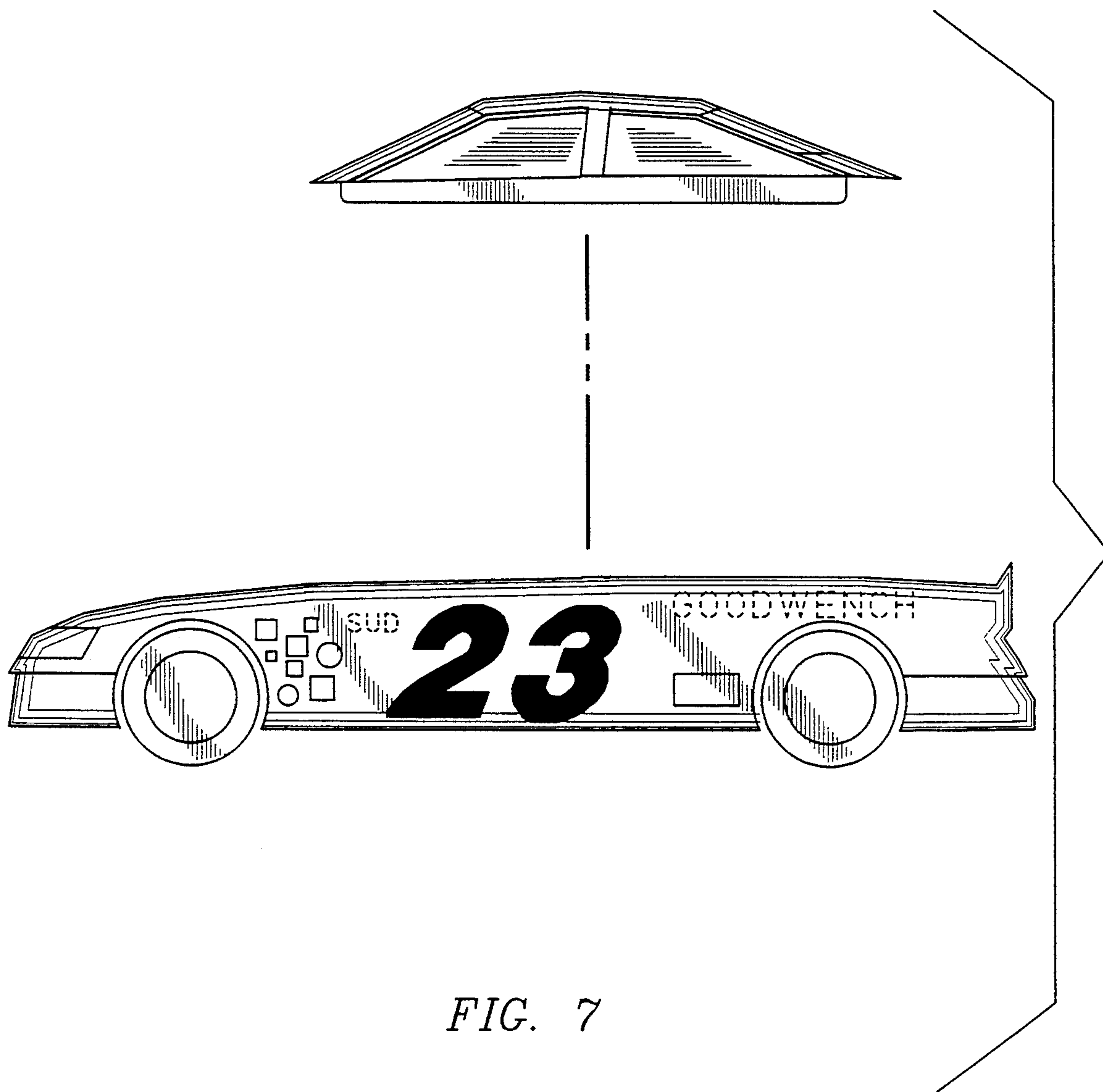

FIG. 7