



US00D349429S

United States Patent [19]
Morehead

[11] **Patent Number: Des. 349,429**
[45] **Date of Patent: ** Aug. 9, 1994**

[54] **INSULATED CONTAINER HOLDER**

[76] **Inventor: Richard D. Morehead, Rte. 1 Box
1-A1, Washington, Okla. 73093**

[**] **Term: 14 Years**

[21] **Appl. No.: 6,153**

[22] **Filed: Mar. 22, 1993**

[52] **U.S. Cl. D7/605**

[58] **Field of Search D7/605, 509, 511, 533,
D7/536; 62/457.2-457.5; 220/737, 739, 740,
741**

[56] **References Cited**

U.S. PATENT DOCUMENTS

D. 336,825 6/1993 Ivey D7/605

Primary Examiner—Terry A. Wallace
Attorney, Agent, or Firm—Hugh E. Smith

[57] **CLAIM**

The ornamental design for an insulated container holder, as shown and described.

DESCRIPTION

FIG. 1 is a front elevational view of the insulated container holder showing my new design; FIG. 2 is a rear elevational view thereof; FIG. 3 is a left side elevational view thereof; FIG. 4 is a right side elevational view thereof; FIG. 5 is a top plan view thereof; FIG. 6 is a bottom plan view thereof; and, FIG. 7 is an exploded cross-sectional view taken along line 7—7 of FIG. 2.

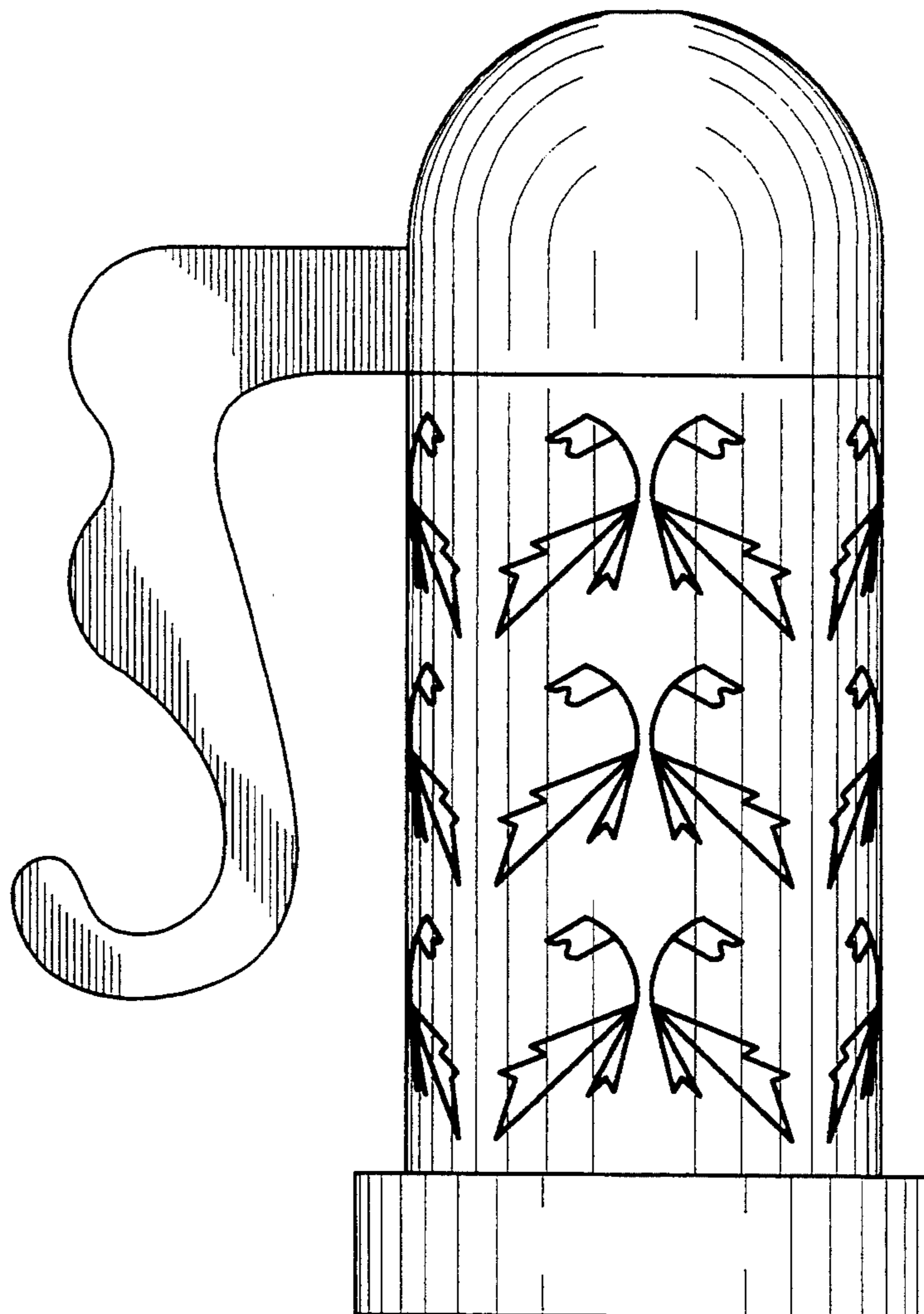

FIG. 1

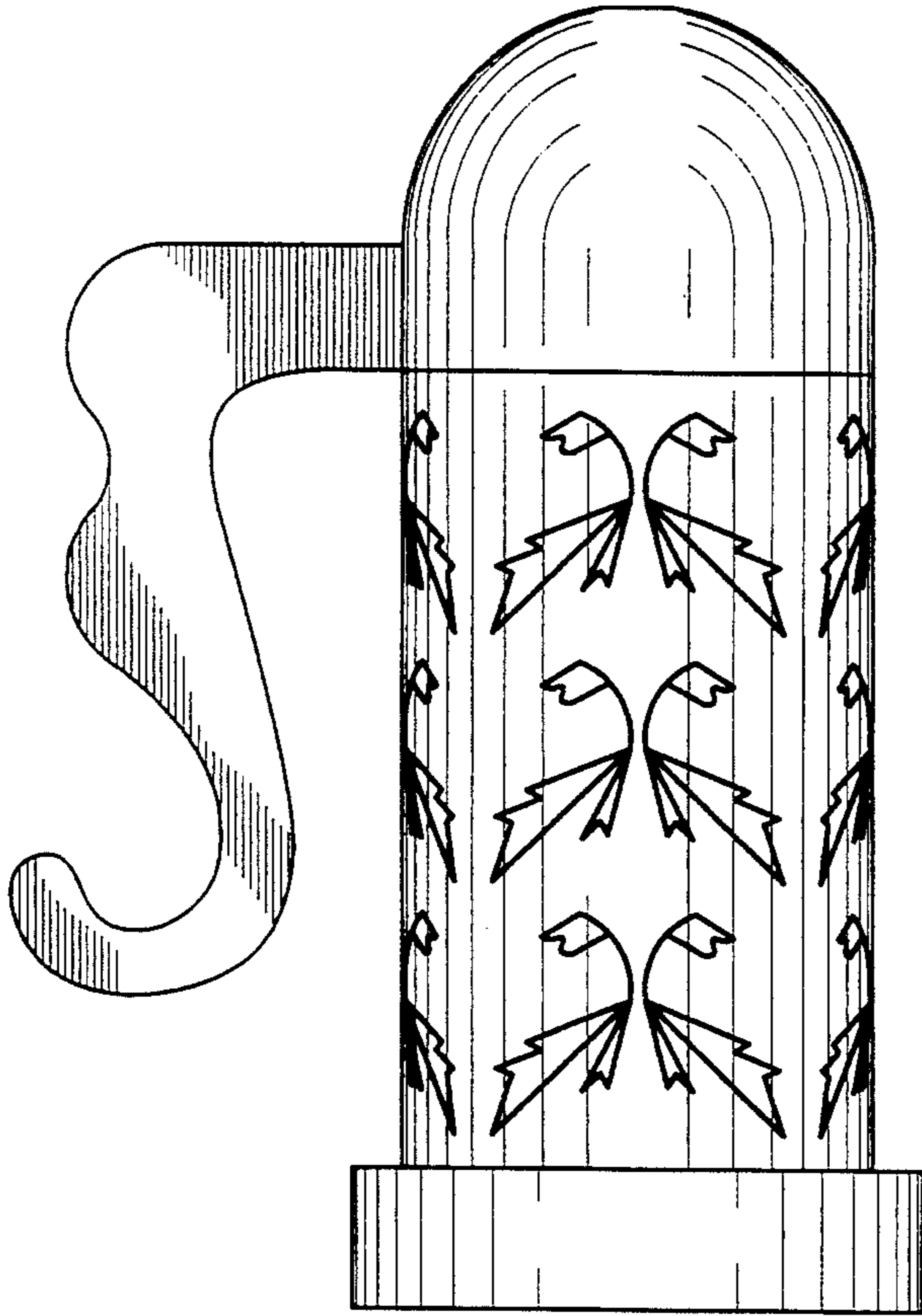

FIG. 2

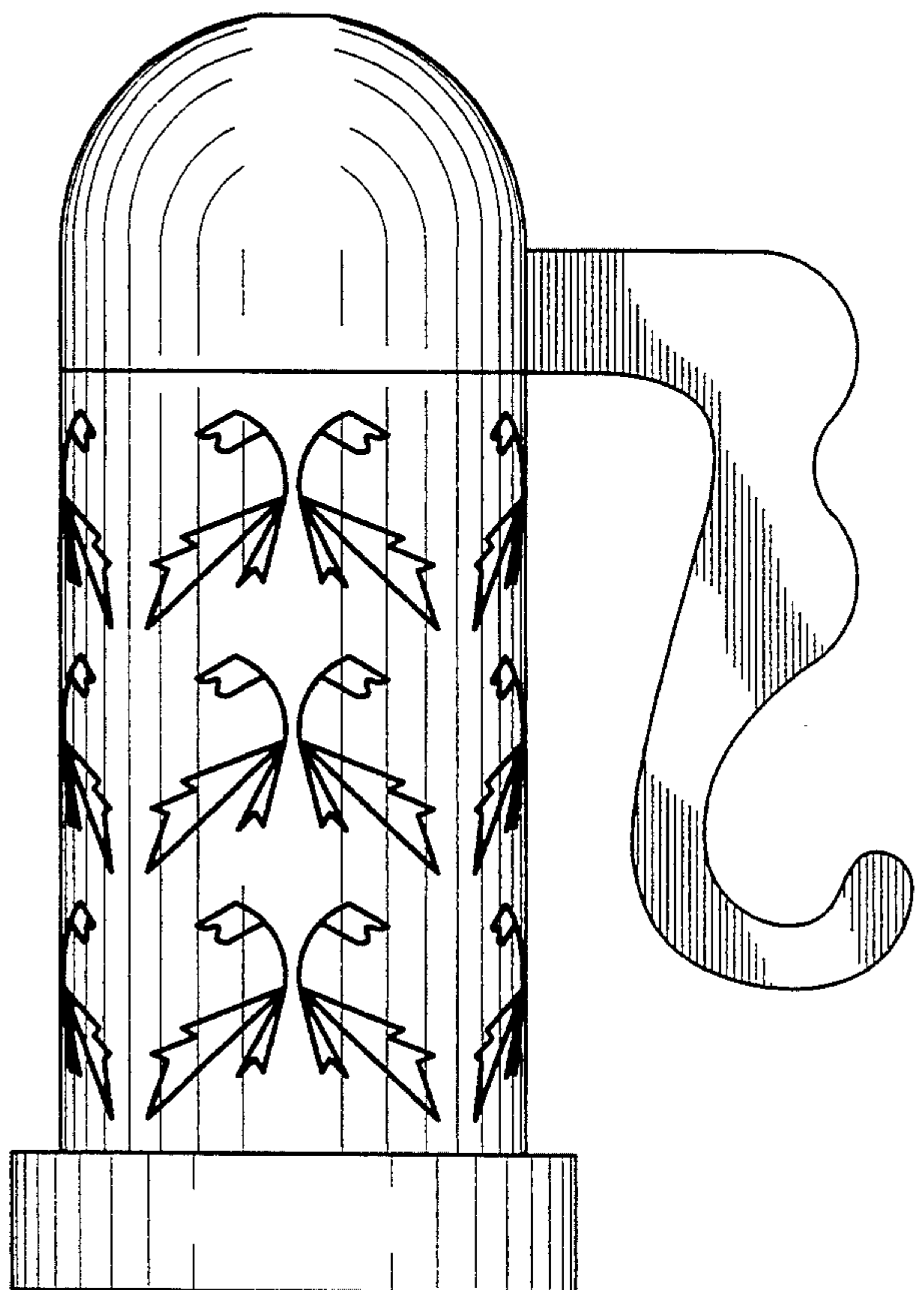

FIG. 3

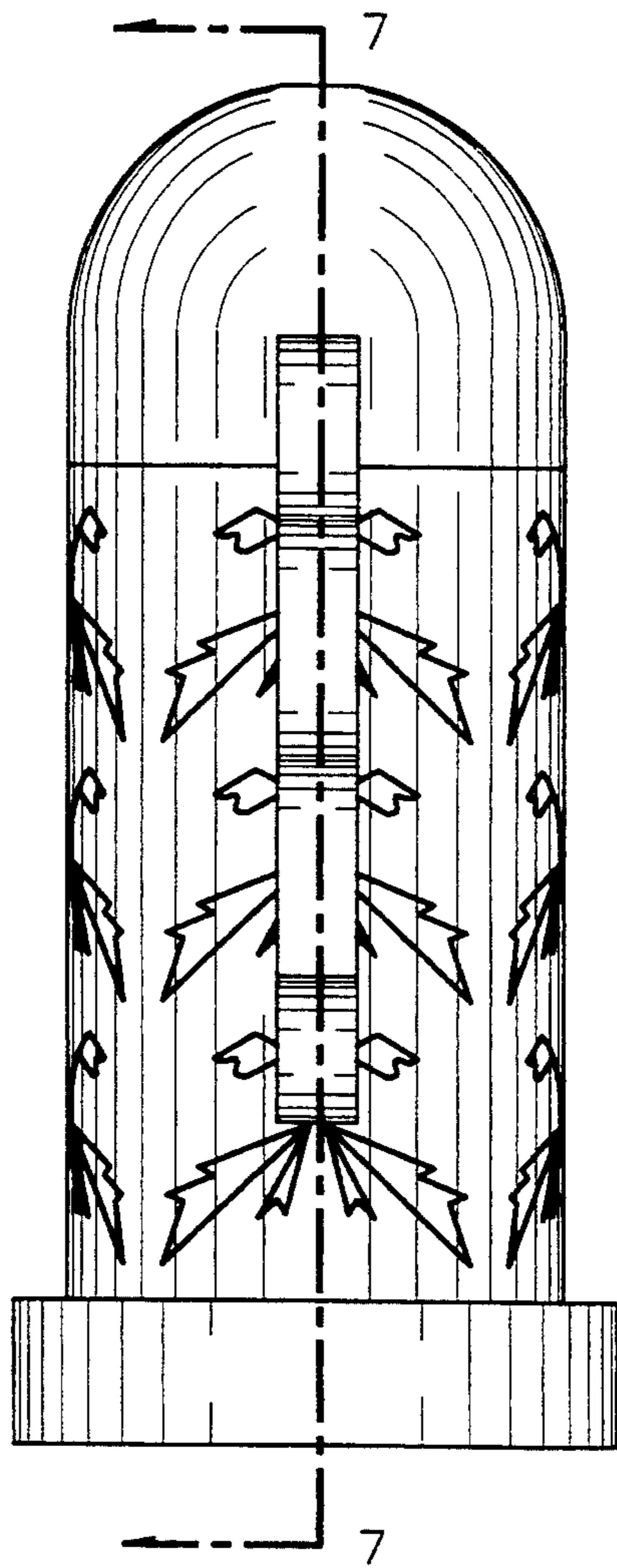

FIG. 4

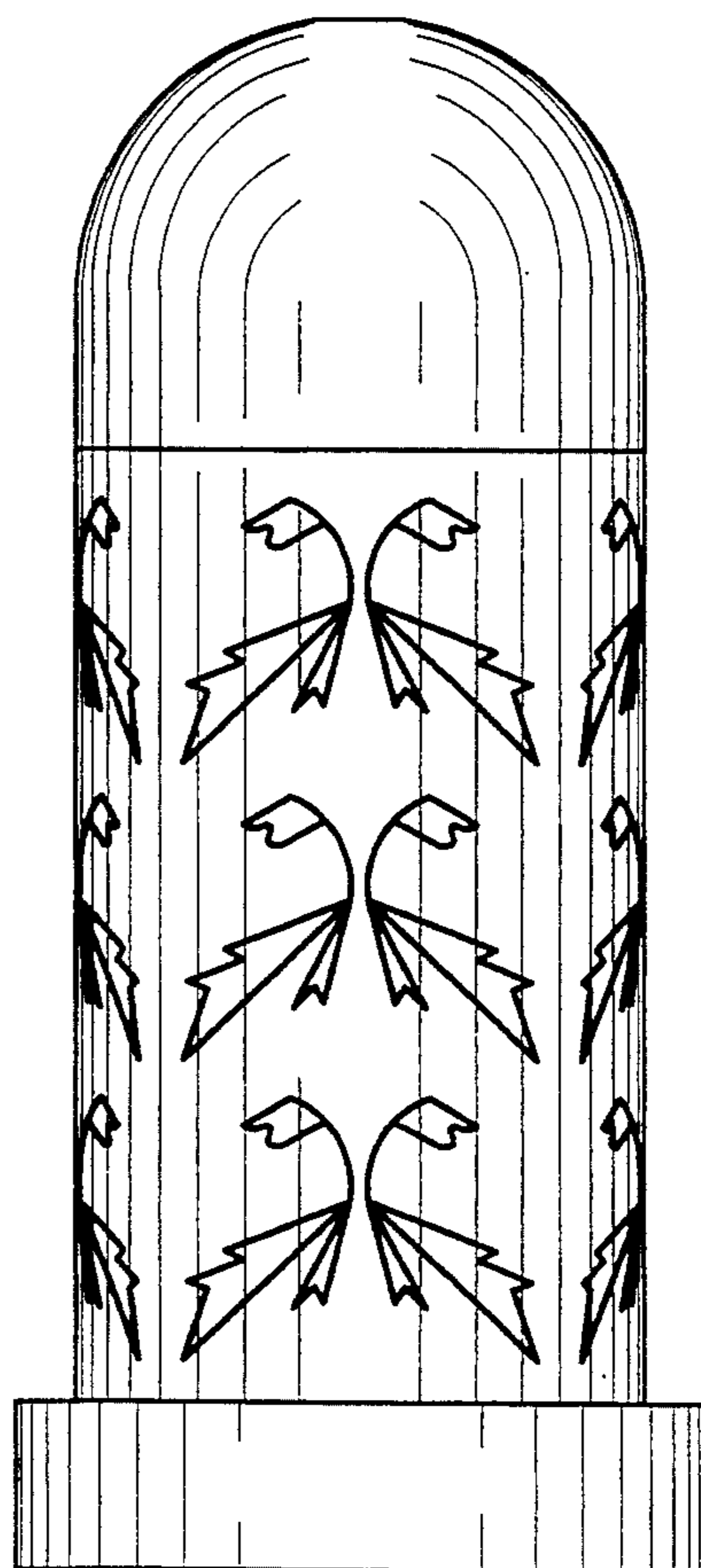

FIG. 5

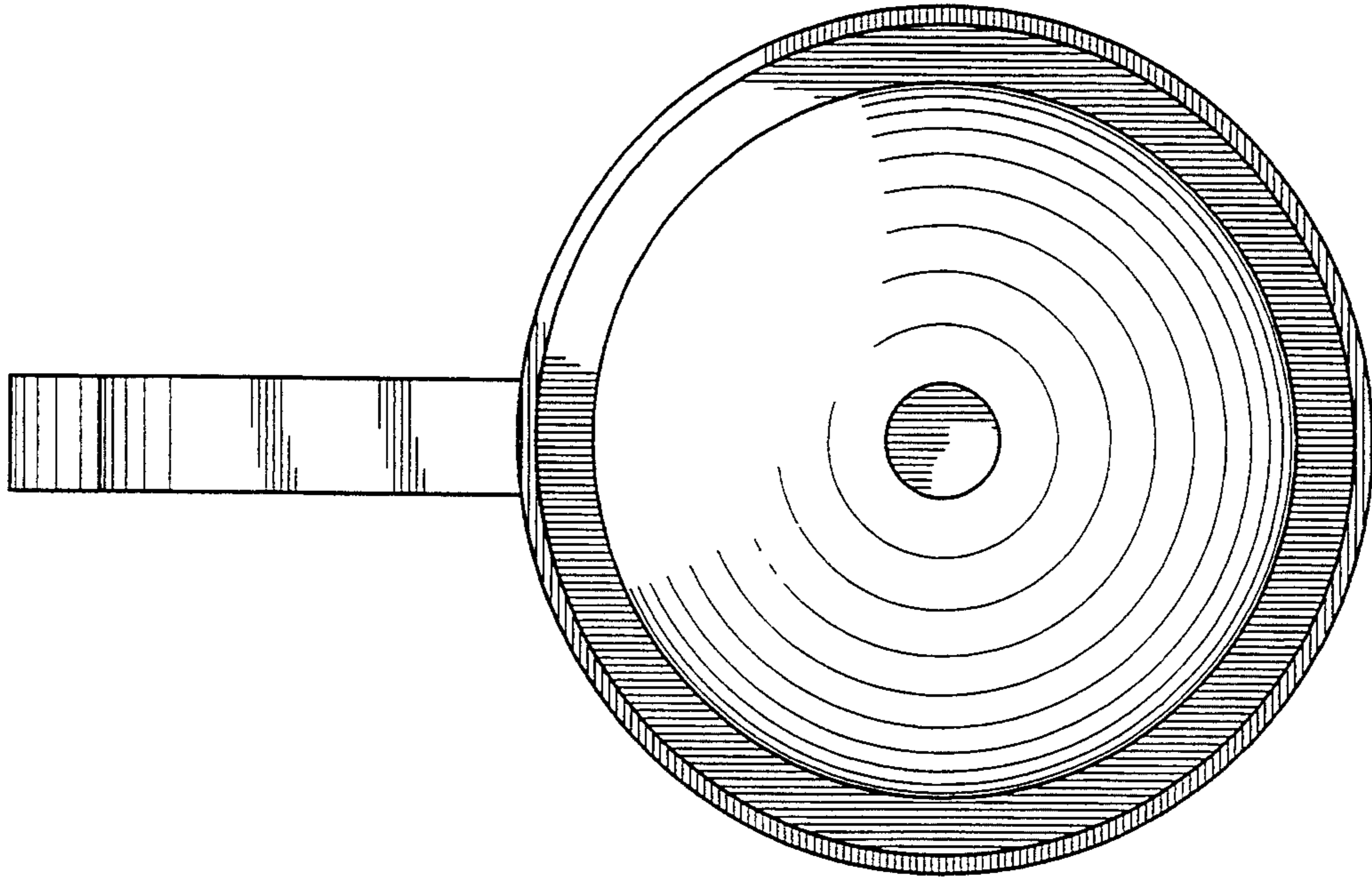

FIG. 6

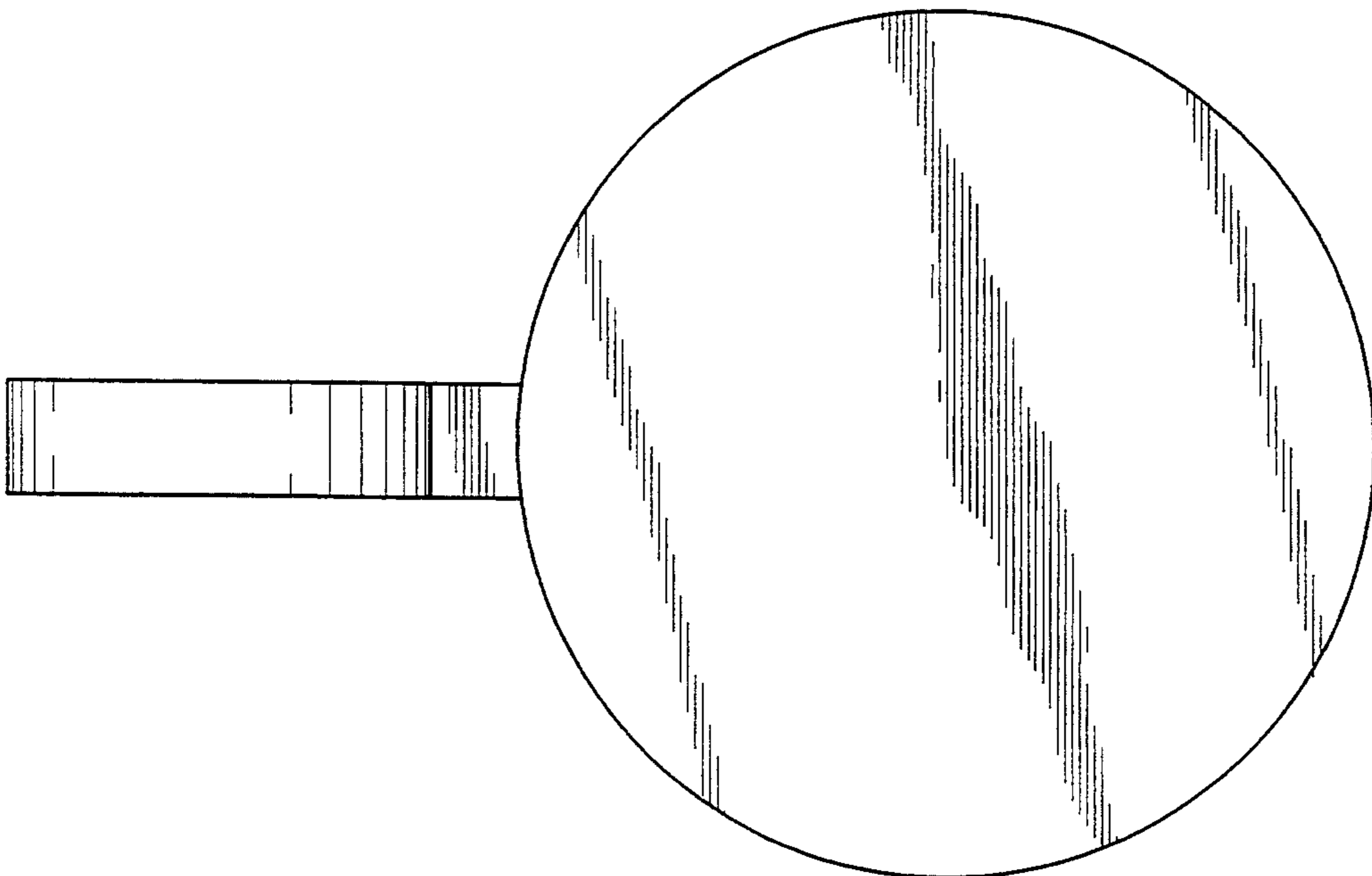

FIG. 7

