



US00D349371S

United States Patent [19]

[11] Patent Number: **Des. 349,371**

Furcron et al.

[45] Date of Patent: **** Aug. 2, 1994**

[54] **BASE FOR AN UPRIGHT VACUUM CLEANER**

[75] Inventors: **Kent J. Furcron**, Blountville, Tenn.;
Mark D. Dziarsk, Simsbury, Conn.

[73] Assignee: **TRC Acquisition Corporation**,
Atlanta, Ga.

[**] Term: **14 Years**

[21] Appl. No.: **818,988**

[22] Filed: **Jan. 10, 1992**

[52] U.S. Cl. **D32/32; D32/31**

[58] Field of Search 15/323-326,
15/327.6, 331-336, 337, 347, 350-351, 361, 377,
412, 413, 415.1; D32/21-22, 31-34

[56] **References Cited**

U.S. PATENT DOCUMENTS

D. 238,139	12/1975	Goodrich	D32/31
D. 263,235	3/1982	Akita	D32/22
D. 293,728	1/1988	Ohhira	D32/22
D. 299,176	12/1988	Bowerman et al.	D32/22
D. 301,784	6/1989	Petralia et al.	D32/22
D. 309,806	8/1990	Chieda et al.	D32/22
D. 316,167	4/1991	Petralia et al.	D32/22
D. 334,262	3/1993	Lawrence et al.	D32/22
2,213,792	9/1940	Dow et al.	15/6
2,876,481	3/1959	Gerber et al.	15/331
2,898,621	8/1959	Vance	15/324
3,126,570	3/1964	Green	15/331
3,634,905	1/1972	Boyd	15/350
3,675,268	7/1972	Nordeen	15/350
3,854,164	12/1974	Schmitz	15/340
4,171,553	10/1979	Stein	15/350

4,405,346	9/1983	Tschudy et al.	55/357
4,490,882	1/1985	Wells	15/337
4,514,199	4/1985	Ford et al.	55/337
4,517,705	5/1985	Hug	15/351
4,670,937	6/1987	Sumerau et al.	15/329
4,686,736	8/1987	Petralia et al.	15/332
4,724,574	2/1988	Bowerman et al.	15/351
5,207,498	5/1993	Lawrence et al.	15/324

OTHER PUBLICATIONS

"Cyclon", *Design*, Aug. 1983, cover and p. 48.
HFD, Jan. 6, 1992, pp. 3A, 4A, and 7A, New York,
N.Y.

Primary Examiner—Ruth McInroy
Attorney, Agent, or Firm—Jones & Askew

[57] CLAIM

The ornamental design for a base for an upright vacuum cleaner, as shown and described.

DESCRIPTION

FIG. 1 is a front, right, top perspective view of a base for an upright vacuum cleaner showing our new design; FIG. 2 is a top plan view thereof; FIG. 3 is a front elevational view thereof; FIG. 4 is a right side elevational view thereof; FIG. 5 is a rear elevational view thereof; FIG. 6 is a left side elevational view thereof; and, FIG. 7 is a bottom plan view thereof.

The broken lines showing of an upright vacuum cleaner body is for illustrative purposes only and forms no part of the claimed design.

The upright vacuum cleaner body shown in broken lines in FIG. 1 is shown for illustrative purposes only and forms no part of the claimed design.

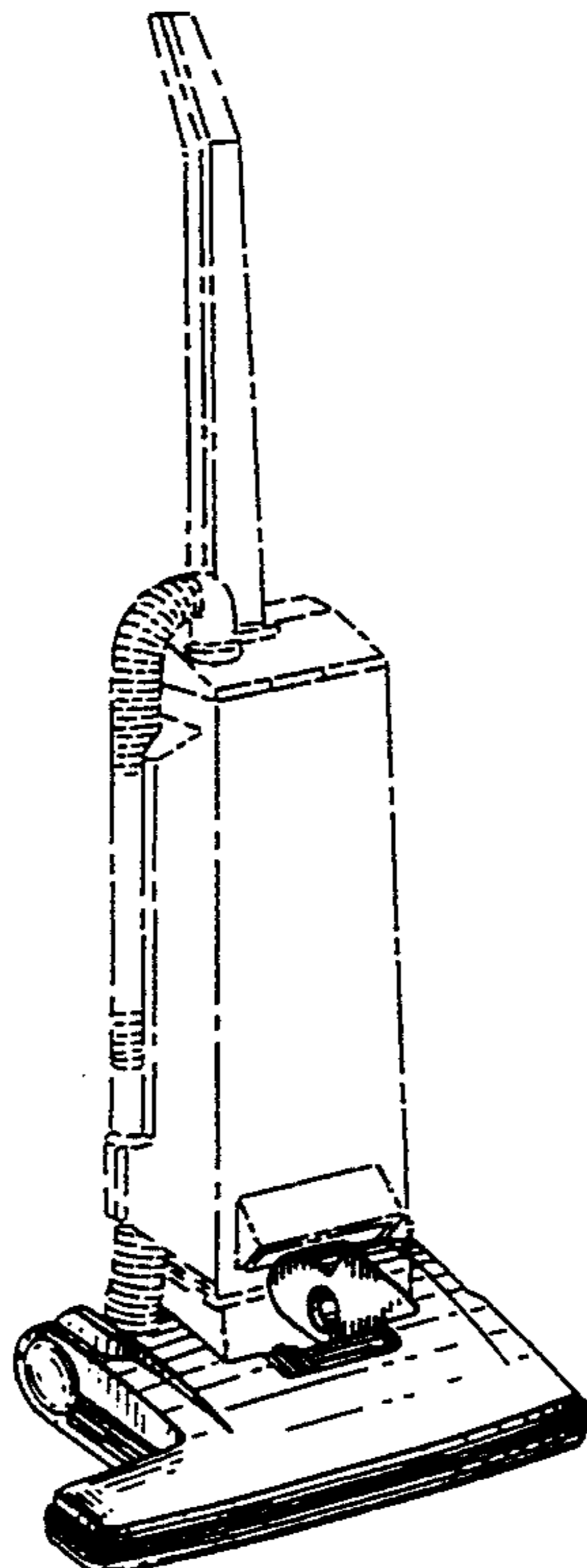

FIG. 1

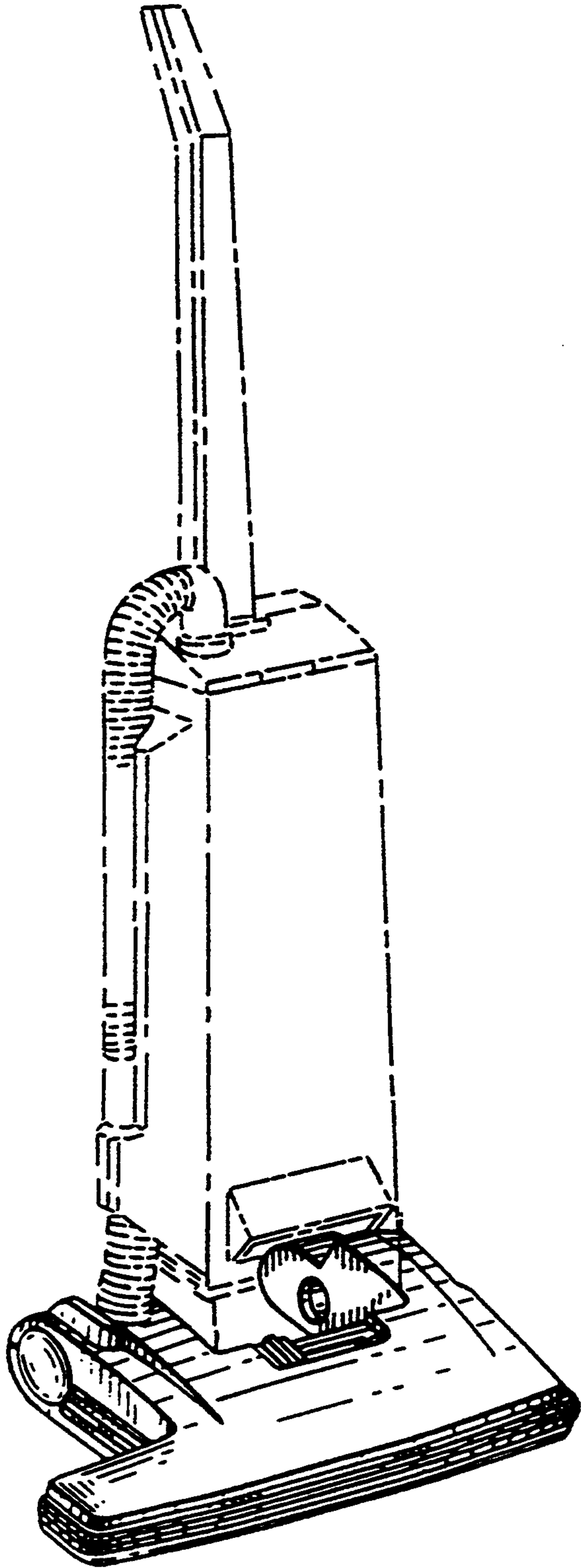

FIG. 2

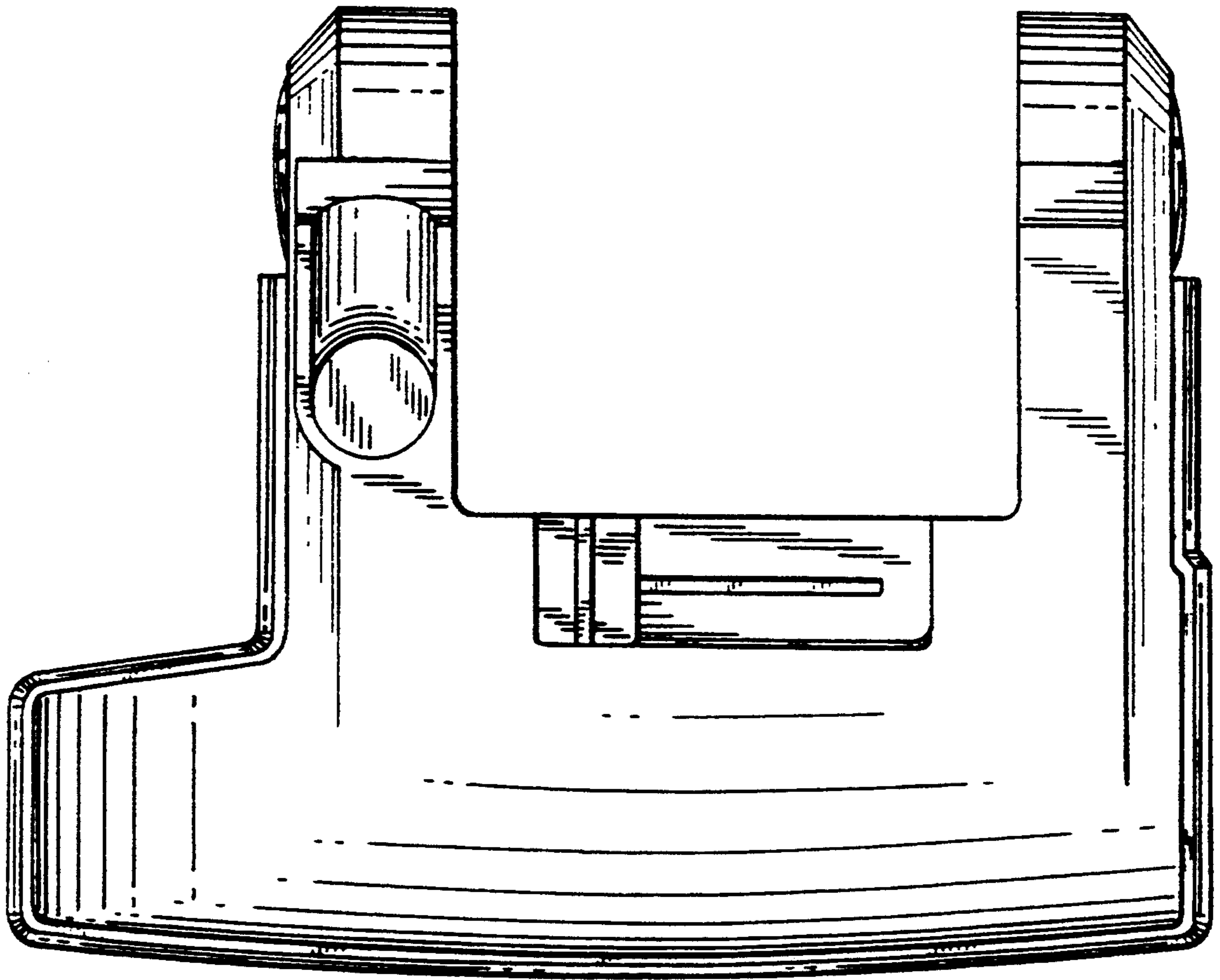

FIG. 3

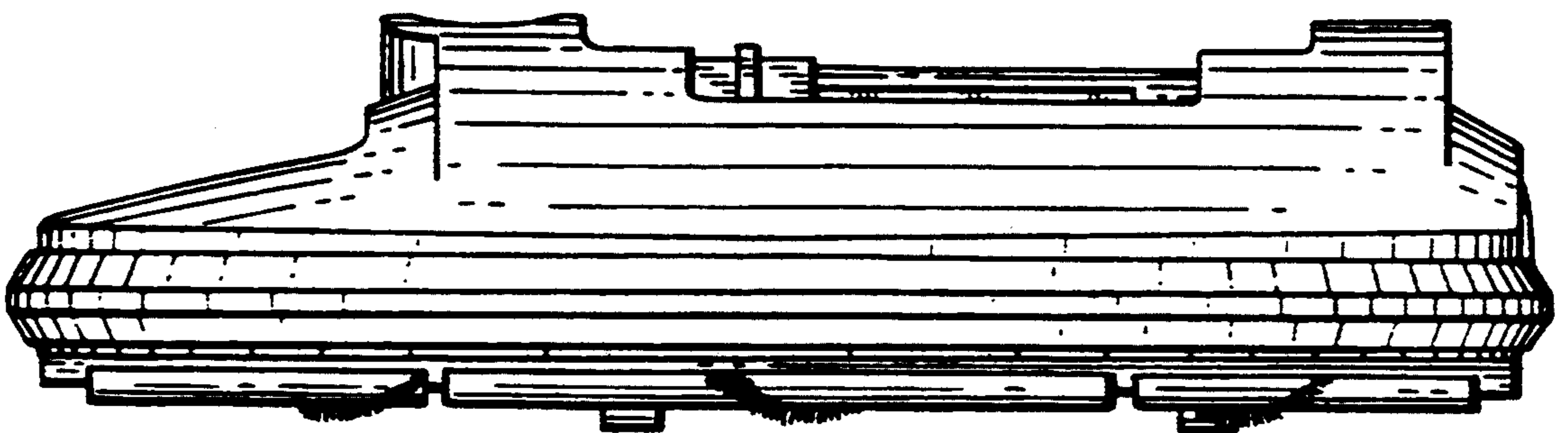

FIG. 4

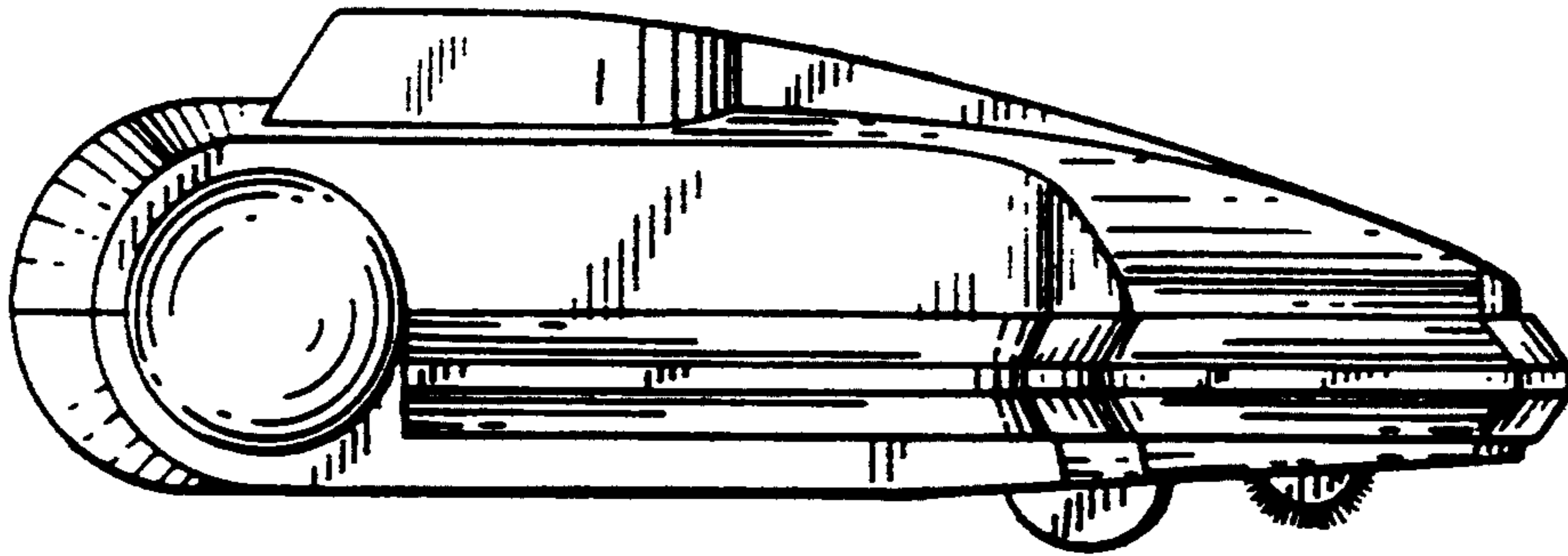

FIG. 5

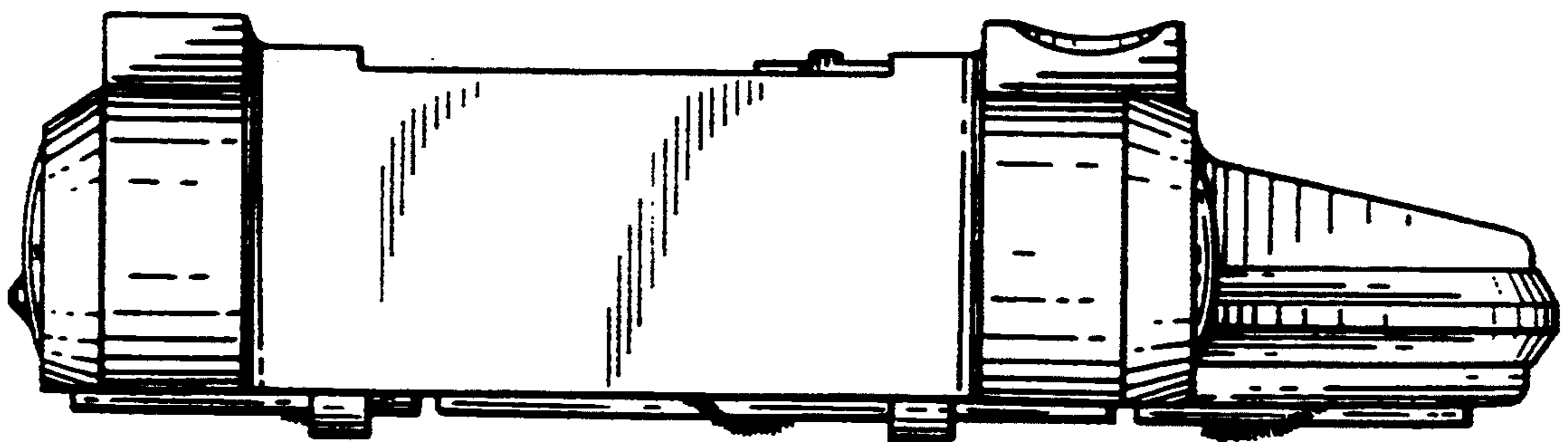

FIG. 6

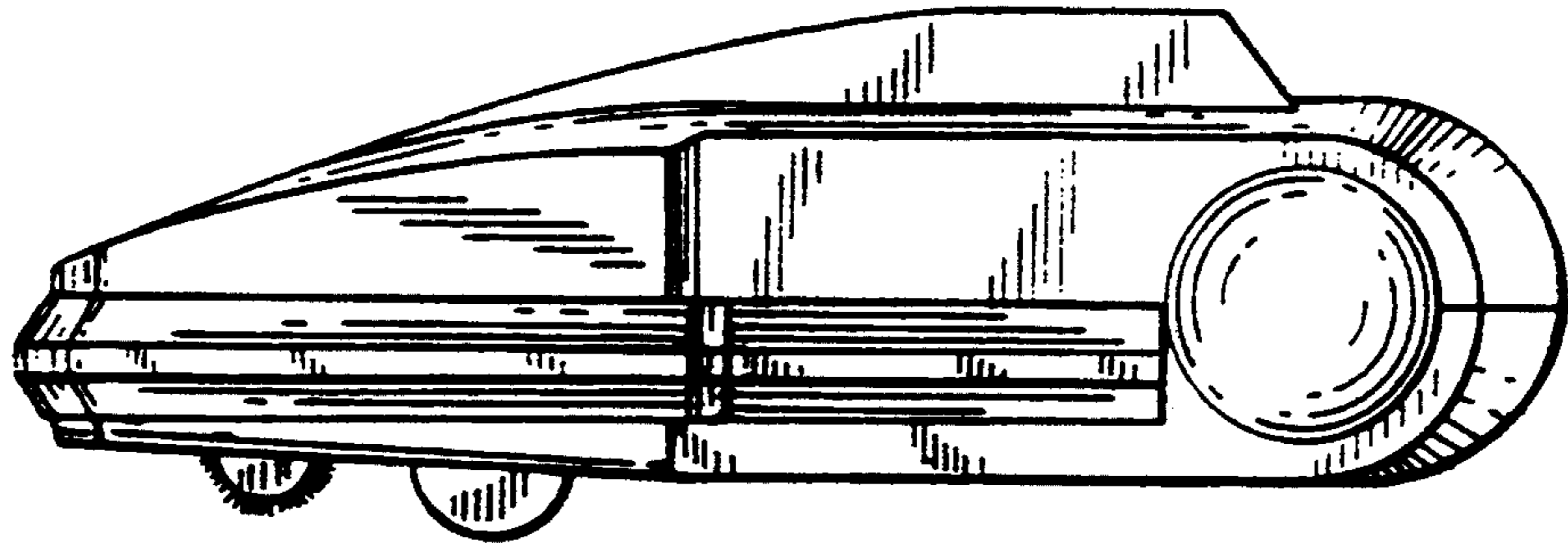

FIG. 7

