



US00D349202S

United States Patent [19]

[11] Patent Number: Des. 349,202

Eliadis et al.

[45] Date of Patent: ** Aug. 2, 1994

[54] **MERCHANDISE DISPLAY**

[75] Inventors: **Luke Eliadis, Stow; James R. Melton, Huron; John A. Vlah, Middlefield, all of Ohio**

[73] Assignee: **American Greetings Corporation, Cleveland, Ohio**

[**] Term: **14 Years**

[21] Appl. No.: **883,413**

[22] Filed: **May 14, 1992**

[52] U.S. Cl. **D6/467; D6/476**

[58] Field of Search **D6/397, 449, 475, 476, D6/466-468, 477-479, 553, 590, 474, 465; 211/50, 59.1, 71, 72, 13, 135, 186, 187**

[56] **References Cited**

U.S. PATENT DOCUMENTS

D. 243,907	4/1977	Ferriter et al.	D6/465 X
D. 265,024	6/1982	Johnson et al.	D6/474 X
D. 321,100	10/1991	Dorrell	D6/476 X
D. 323,766	2/1992	Robbins et al.	D6/553 X
D. 328,538	8/1992	Berger	D6/468
4,585,128	4/1986	Hannecke	211/50 X
4,765,492	8/1988	Howard et al.	D6/449 X
4,951,827	8/1990	Moransais	211/59.1

Primary Examiner—Alan P. Douglas
Assistant Examiner—Jeffrey Asch
Attorney, Agent, or Firm—Calfee, Halter & Griswold

[57] **CLAIM**

The ornamental design for a merchandise display, as shown and described.

DESCRIPTION

FIG. 1 is a top, front, and left side perspective view of a merchandise display showing our new design;
 FIG. 2 is a front elevational view;
 FIG. 3 is a top plan view;
 FIG. 4 is a left side elevational view;
 FIG. 5 is a right side elevational view;
 FIG. 6 is a rear elevational view;
 FIG. 7 is a bottom plan view;
 FIG. 8 is an enlarged fragmentary view showing the slat wall bracket for support of products;
 FIG. 9 is a top, front, and left side perspective view of a second embodiment of that shown in FIG. 1;
 FIG. 10 is an enlarged fragmentary view showing the divider vanes of the cylindrical pillar;
 FIG. 11 is a front elevational view, the rear being the same in appearance as the first embodiment as shown in FIG. 6;
 FIG. 12 is a top plan view; and,
 FIG. 13 is a right side elevational view thereof.

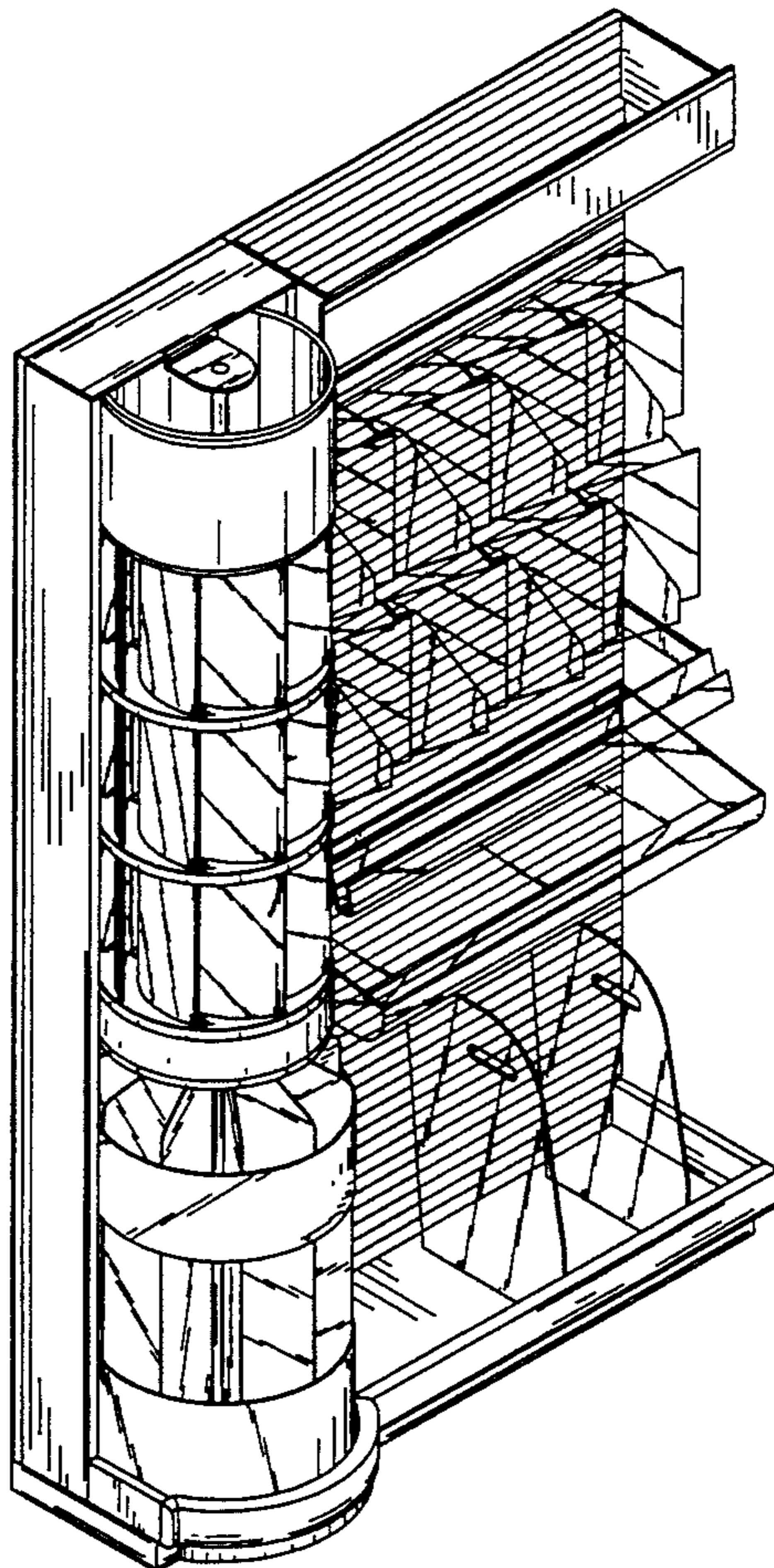

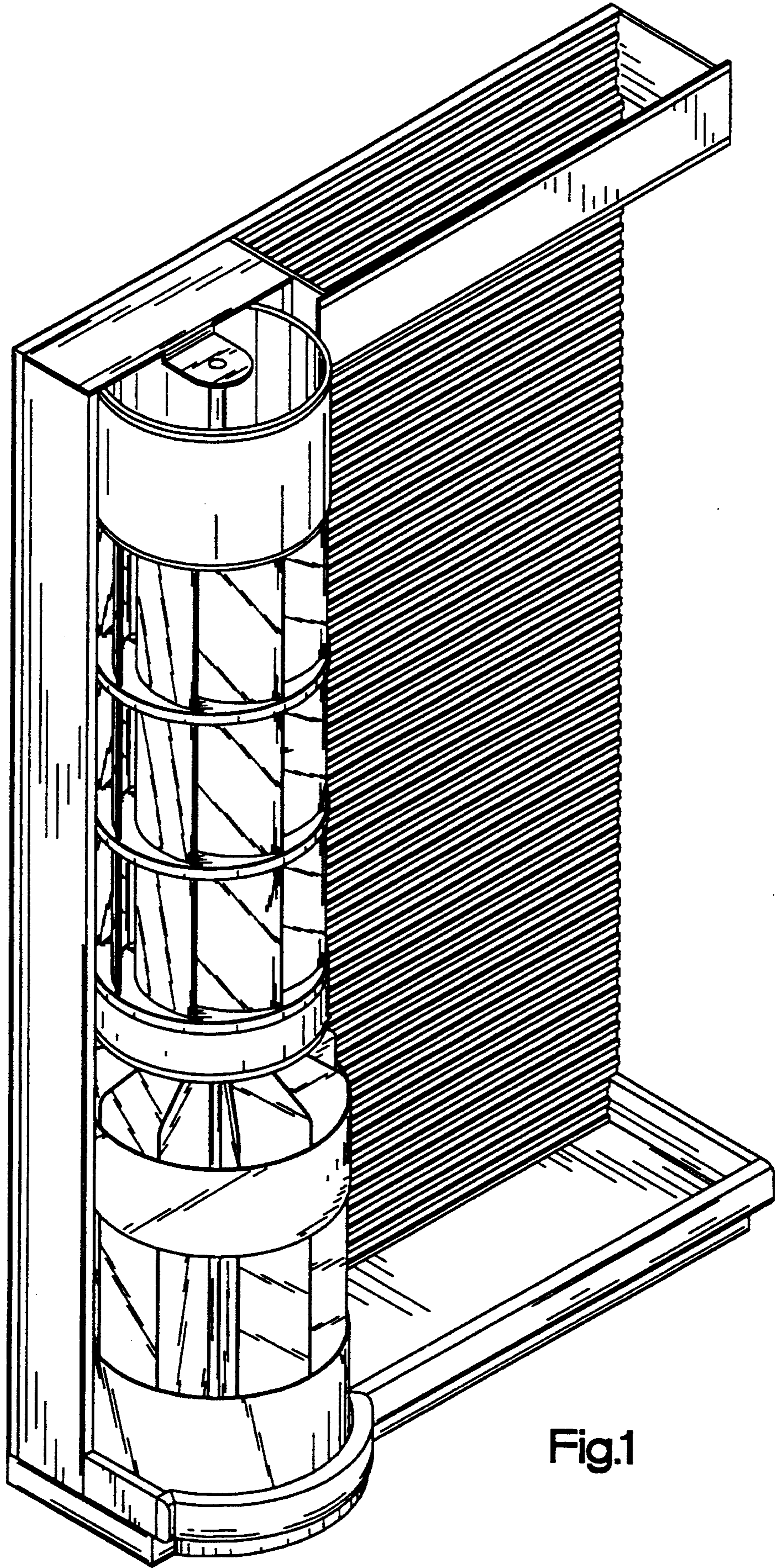

Fig. 1

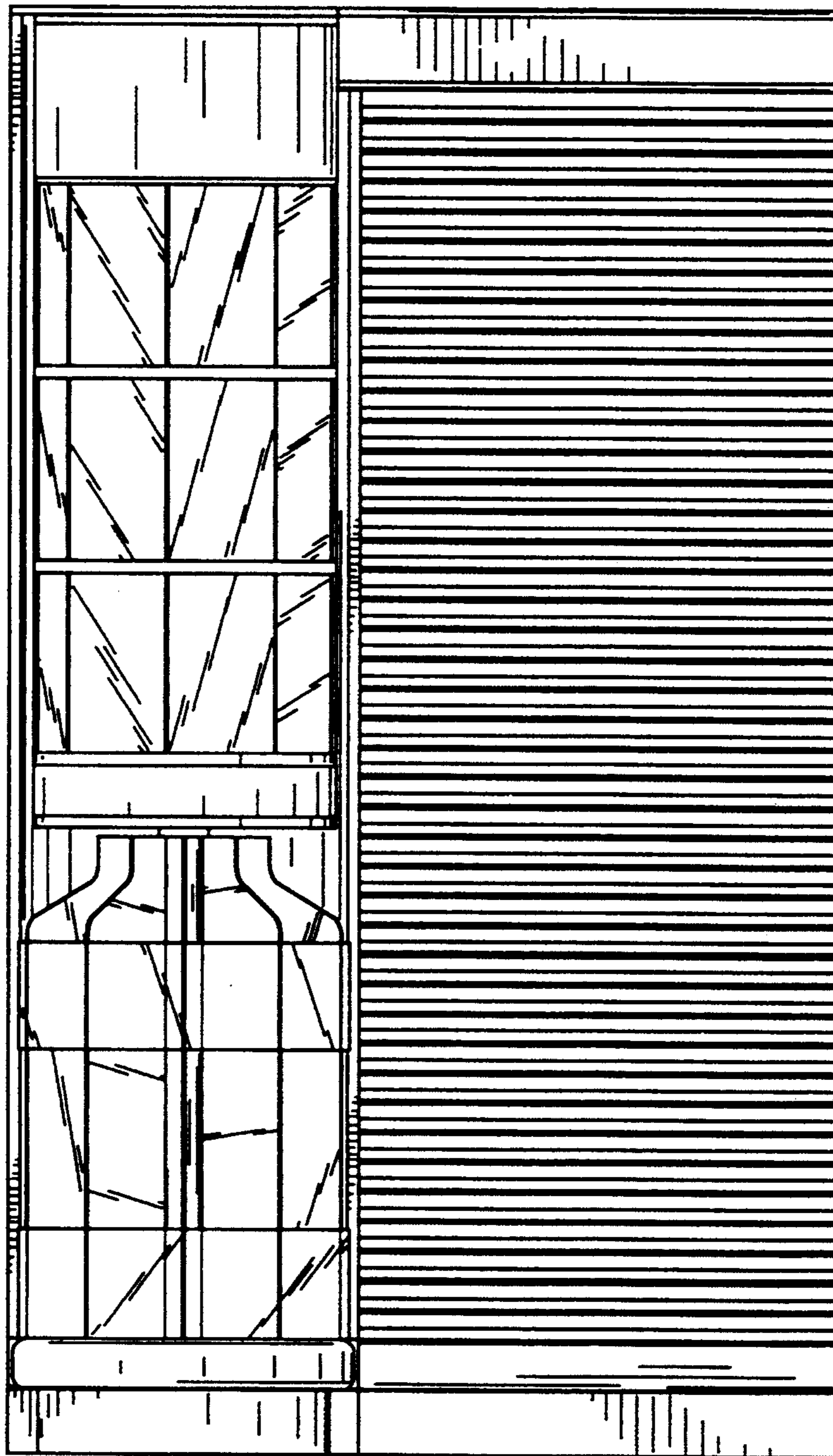

Fig.2

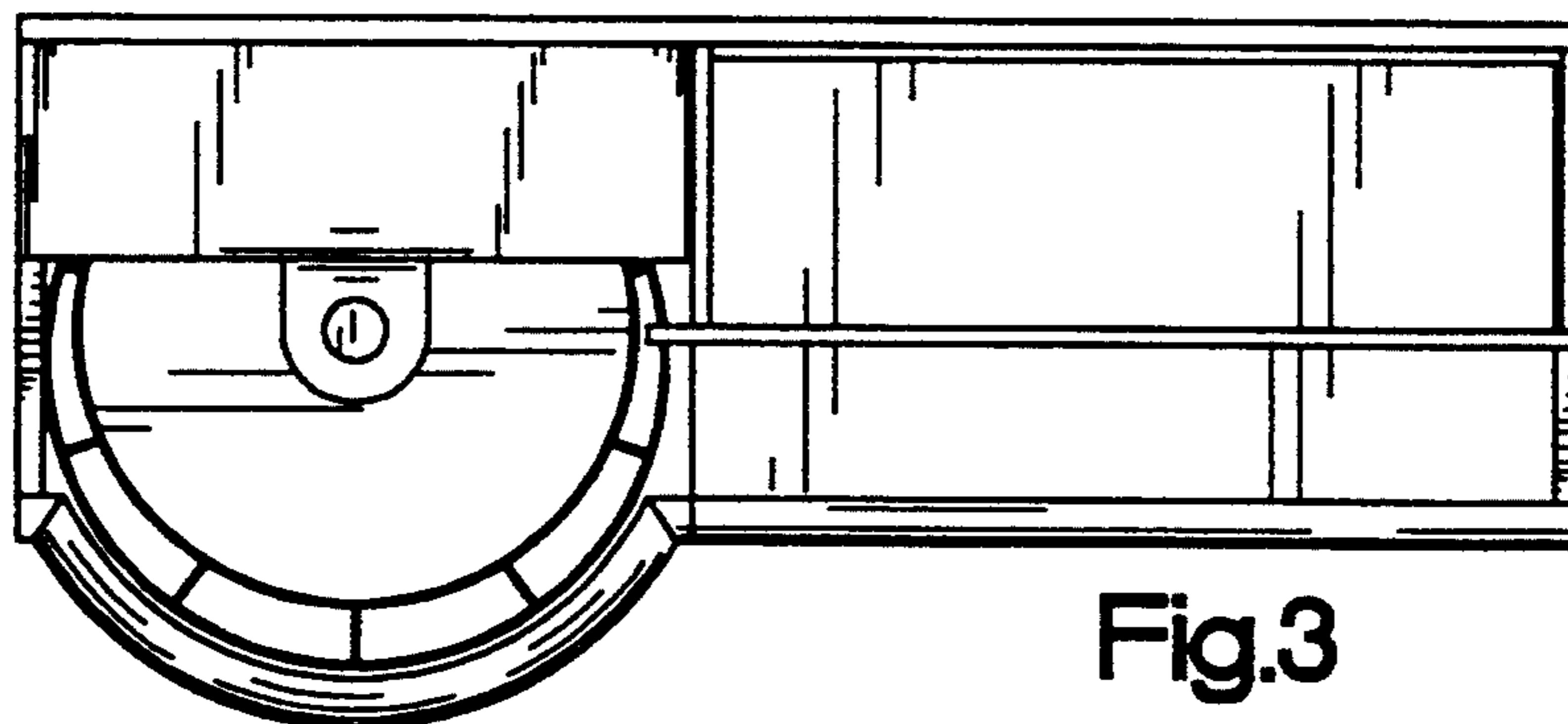

Fig.3

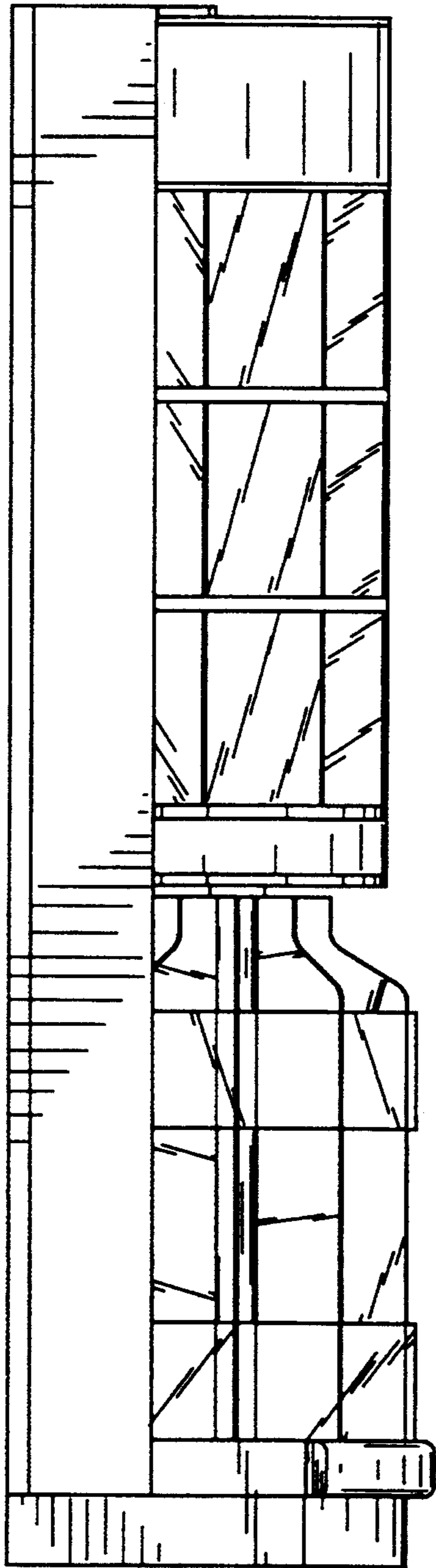

Fig.4

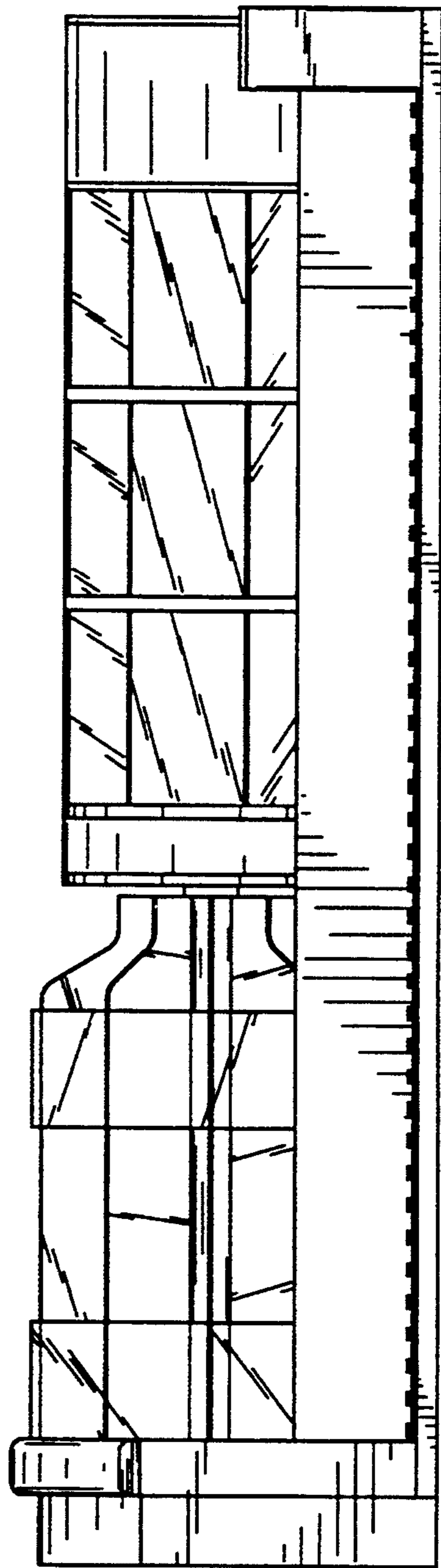

Fig.5

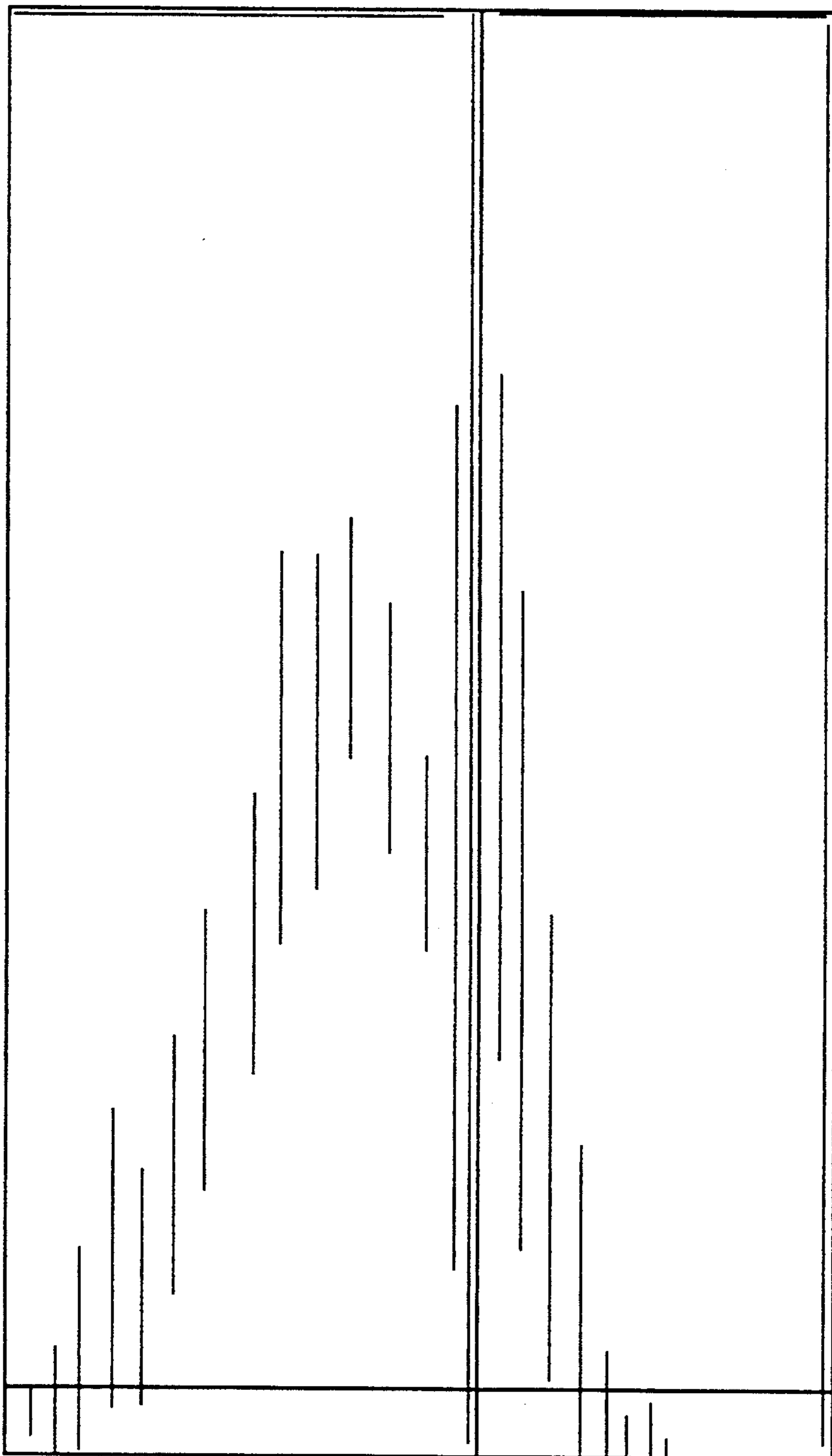

Fig.6

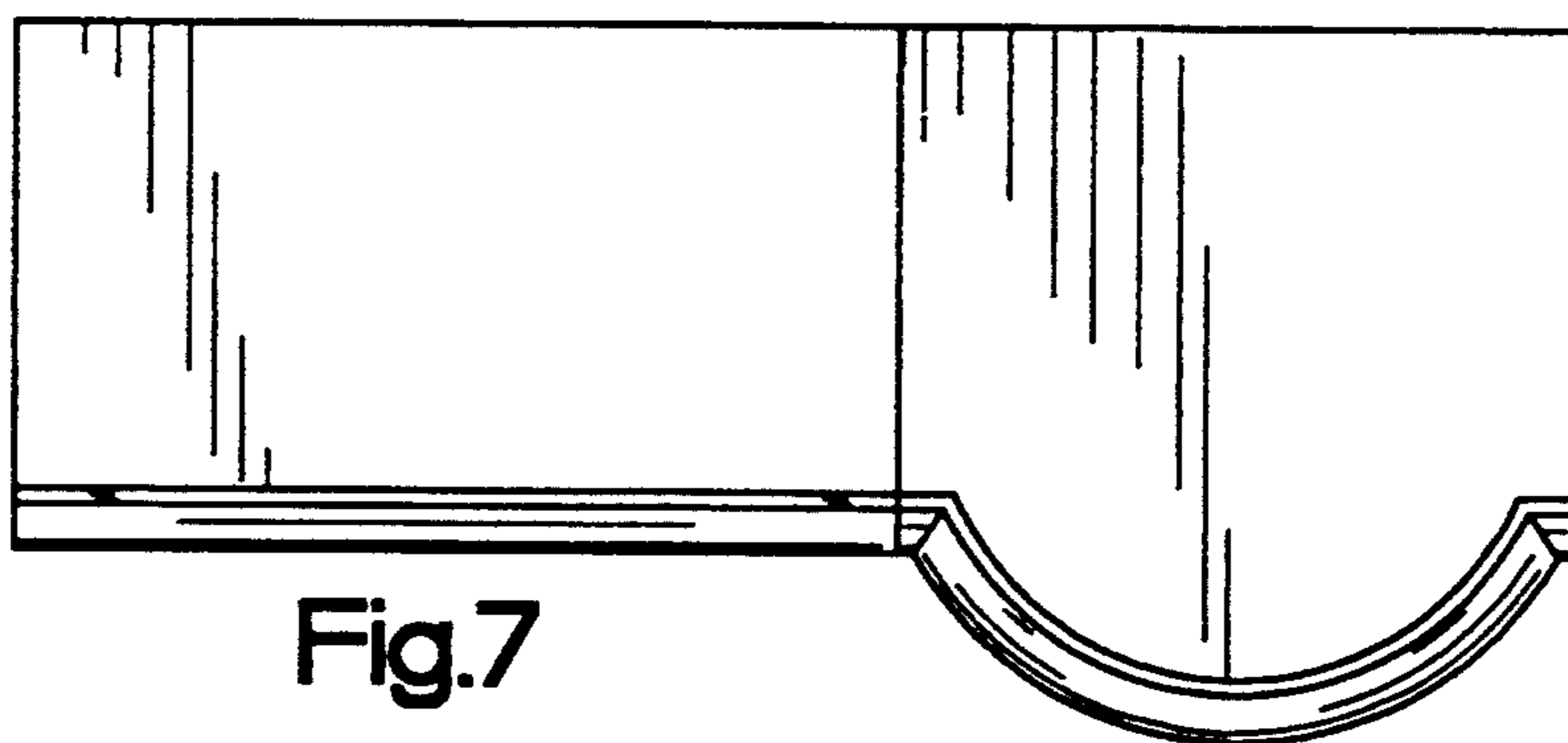

Fig.7

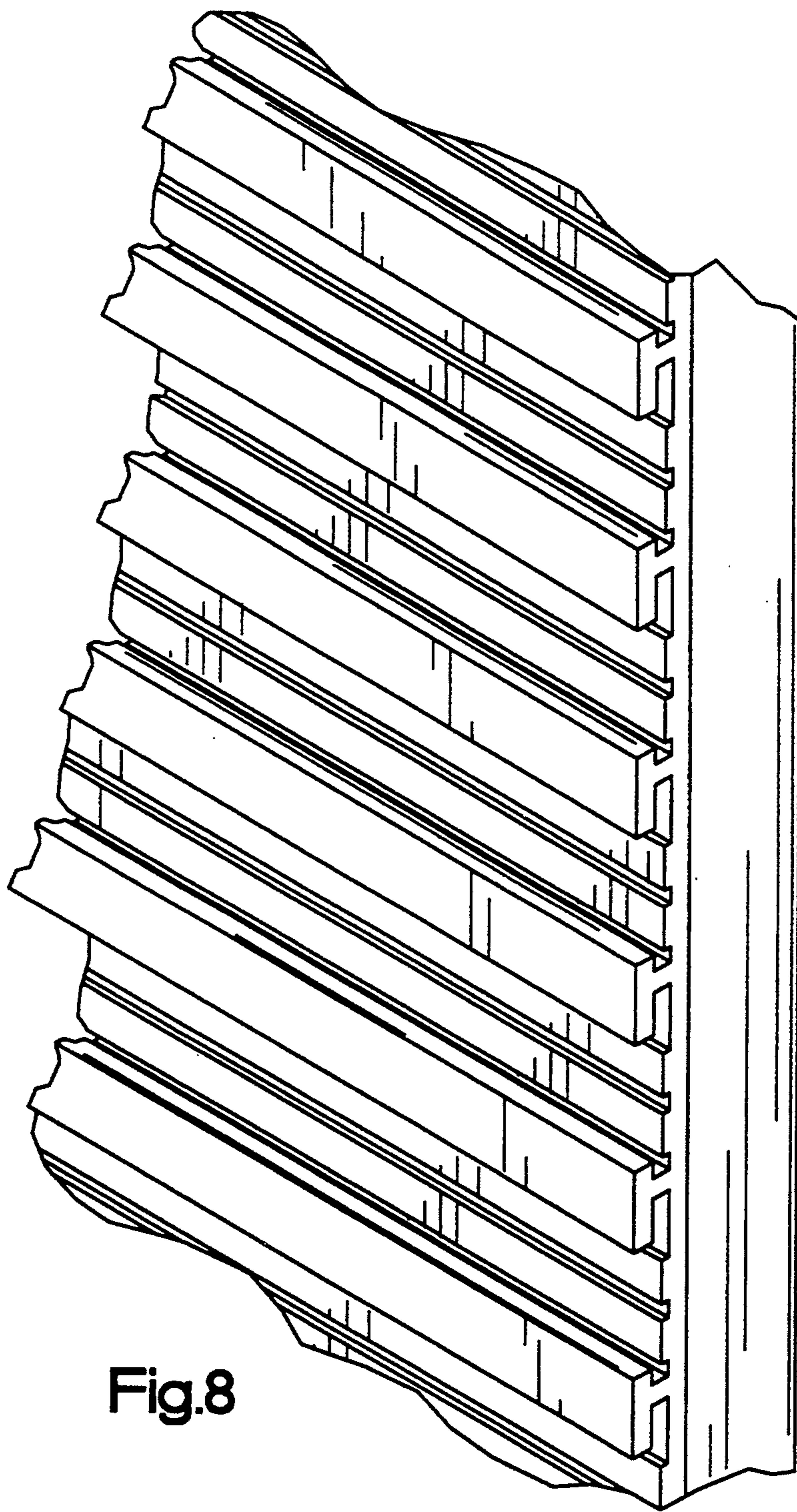

Fig.8

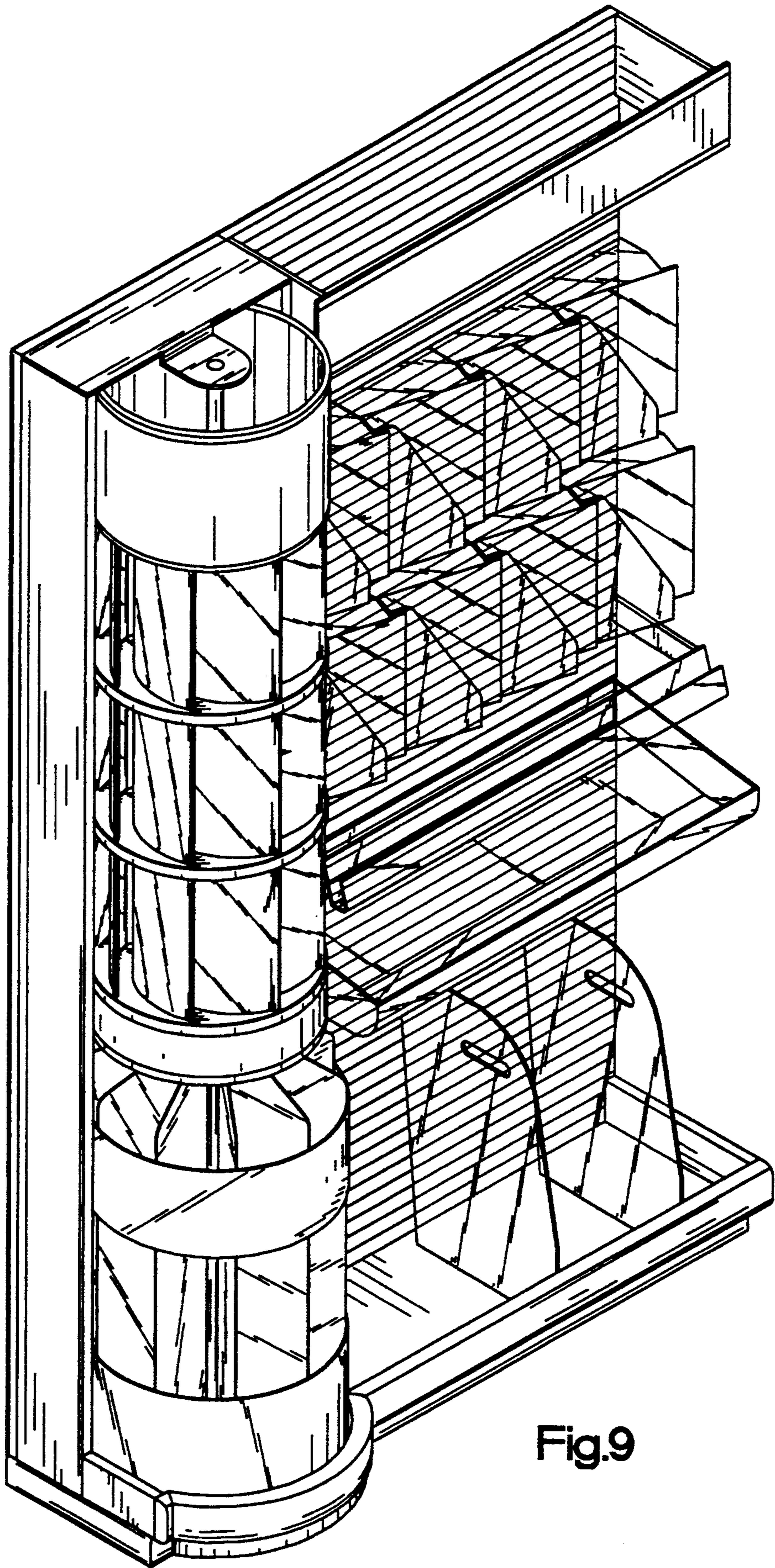

Fig.9

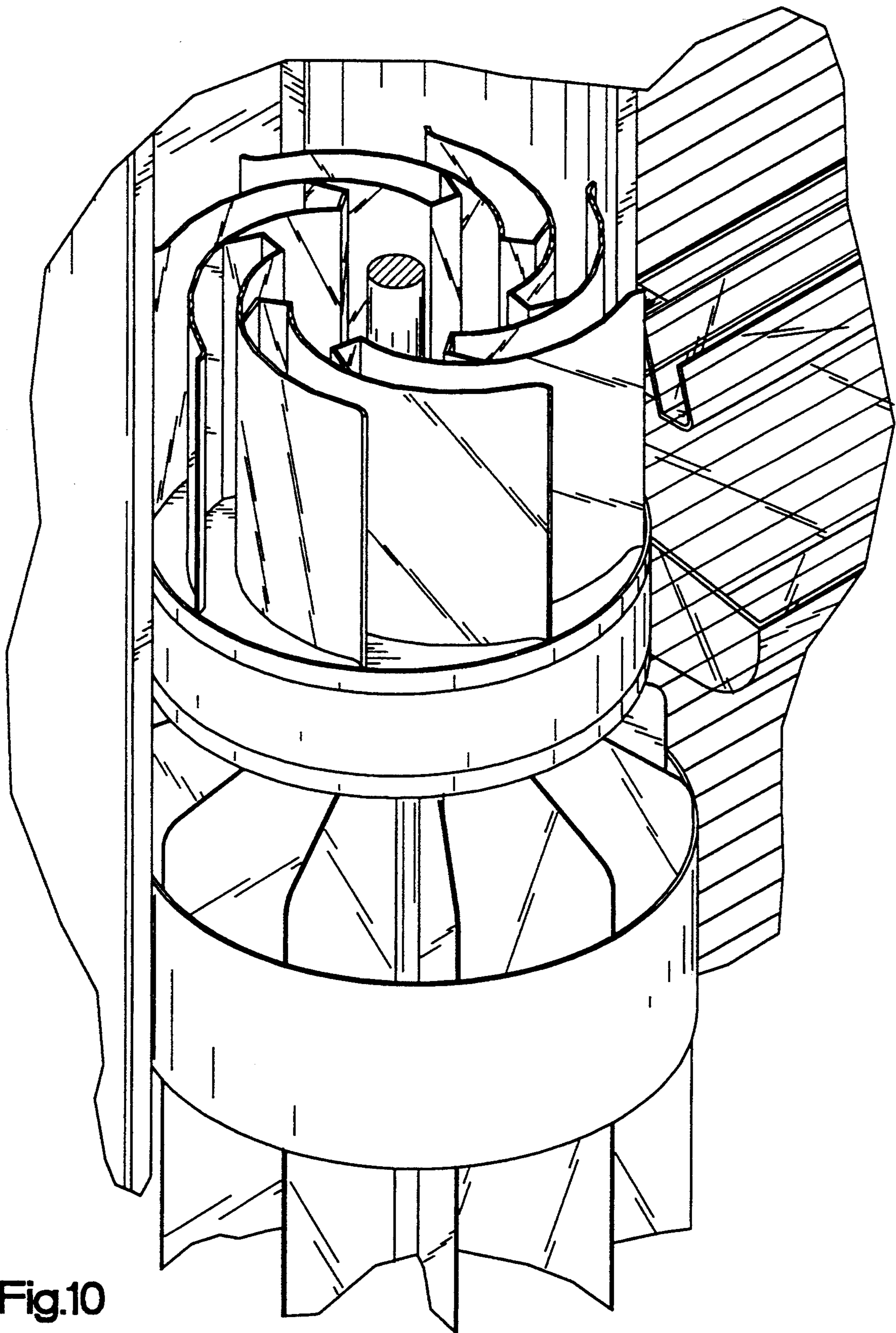

Fig.10

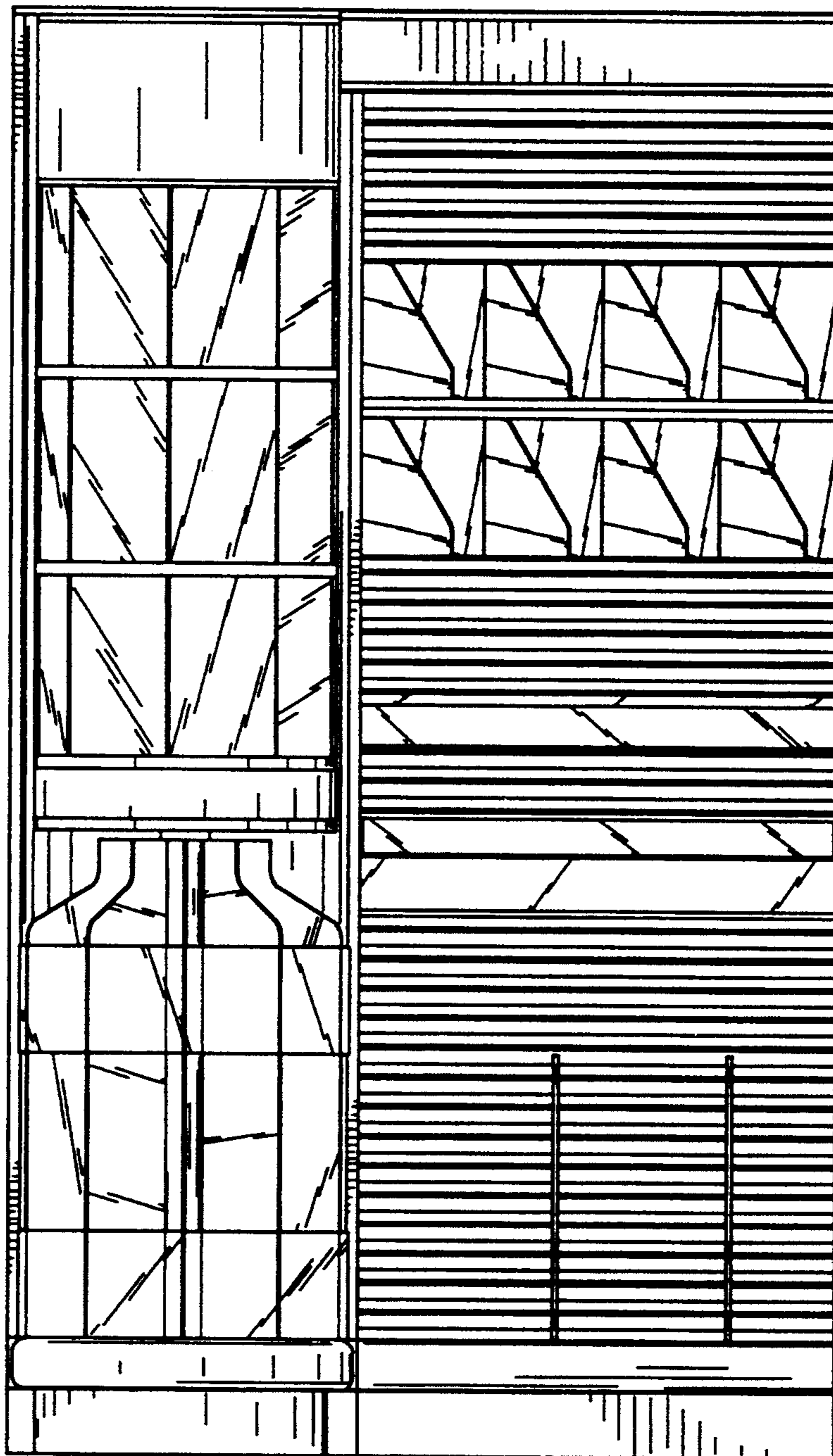

Fig.11

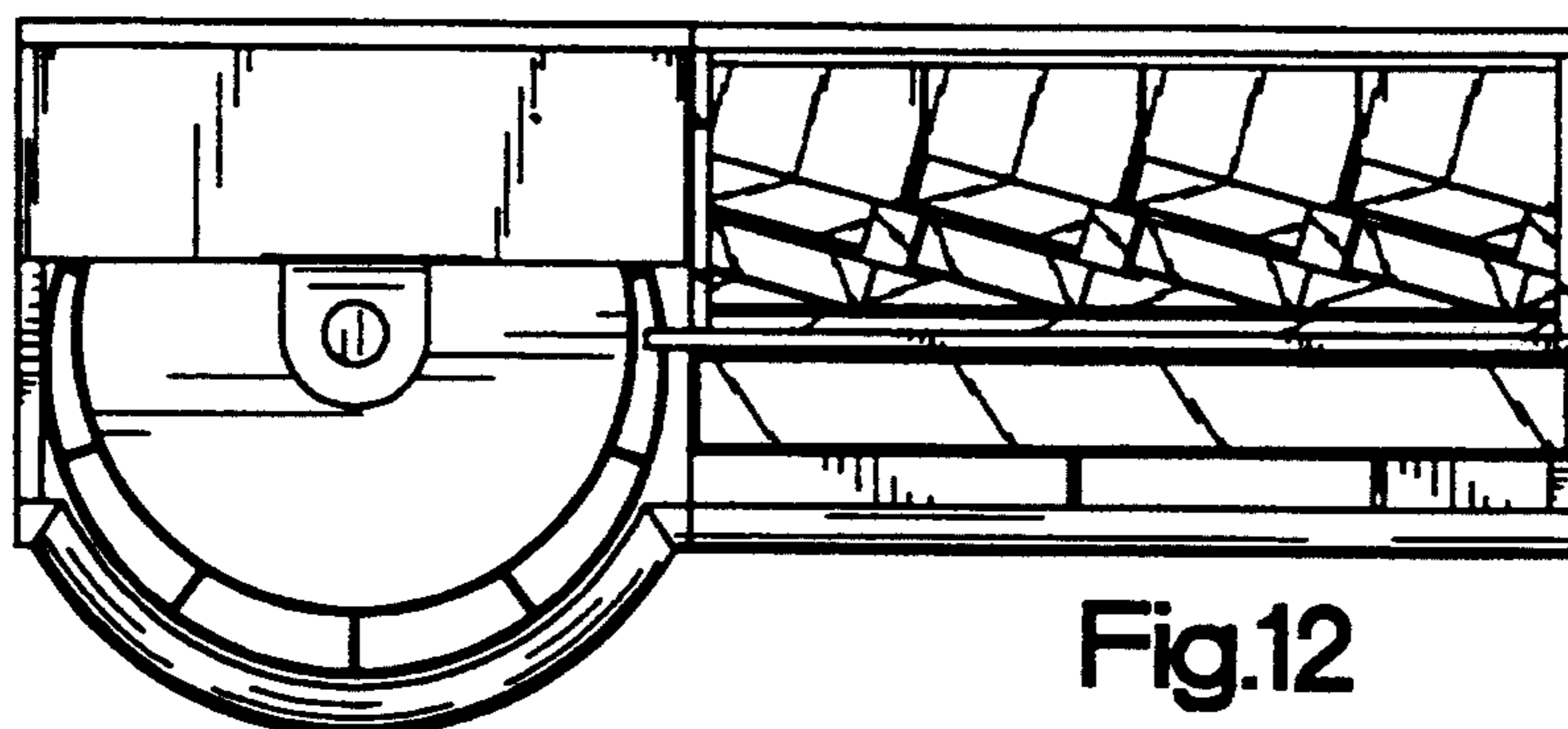

Fig.12

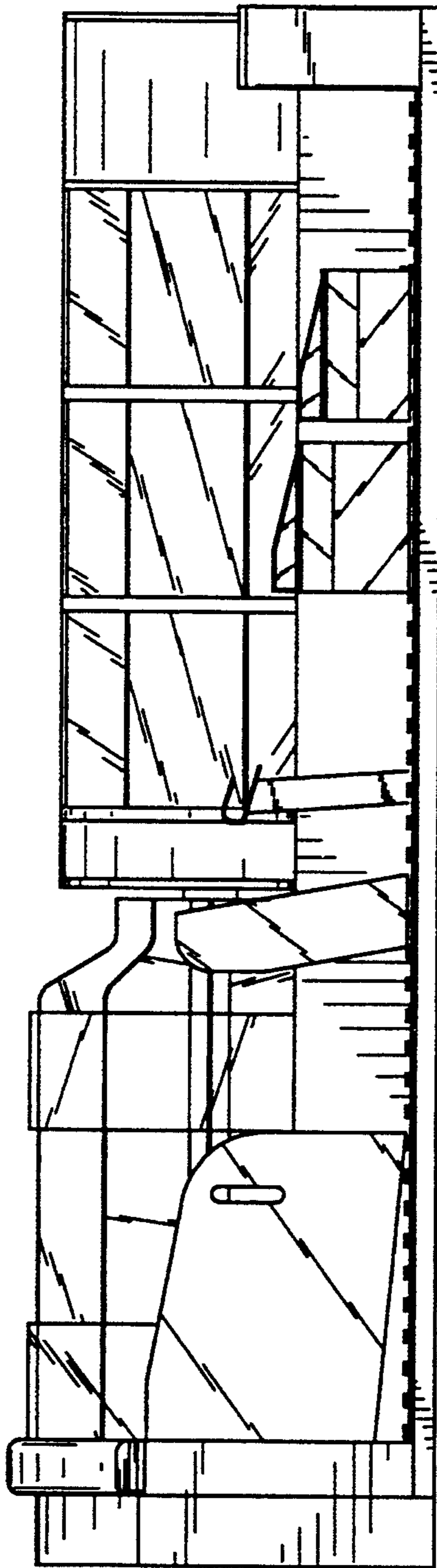

Fig.13