



US00D349130S

United States Patent [19]

[11] Patent Number: **Des. 349,130**

Nigris et al.

[45] Date of Patent: **** Jul. 26, 1994**

[54] **CLIPBOARD FOR A SHOPPING CART PUSH BAR**

D. 302,988	8/1989	Zinter-Chahin	D21/59
D. 315,366	3/1991	Greenspahn	D19/88 X
D. 318,881	8/1991	Chase	D19/88
D. 329,061	9/1992	Szablak et al.	19/88

[76] Inventors: **Kerena Nigris**, 29 Simms Drive, Ajax, Ontario, Canada, L1T 3J5;
Judi Neilson, 103 Daniels Cres., Ajax, Ontario, Canada, L1T 1Y9

Primary Examiner—Nelson C. Holtje
Assistant Examiner—Martie Thompson
Attorney, Agent, or Firm—Terry M. Gernstein

[**] Term: **14 Years**

[57] **CLAIM**

[21] Appl. No.: **892,015**

The ornamental design for a clipboard for a shopping cart push bar, as shown and described.

[22] Filed: **Jun. 3, 1992**

DESCRIPTION

[52] U.S. Cl. **D19/88; D19/90**

[58] Field of Search 21/59; 248/441.1, 442.2;
D19/35, 36, 52, 65, 75, 78, 86, 88, 90, 91

FIG. 1 is a top, right front perspective view of a clipboard for a shopping cart push bar showing our new design;

[56] **References Cited**

U.S. PATENT DOCUMENTS

D. 290,548	6/1987	Stambler	D21/59
D. 293,254	12/1987	Appel	D21/59
D. 298,956	12/1988	Zinter-Chahin	D21/59
D. 301,489	6/1989	Aquila et al.	D19/88

FIG. 2 is a front elevational view thereof;

FIG. 3 is a rear elevational view thereof;

FIG. 4 is an end elevational view thereof, the end opposite being a mirror image of the end shown in FIG. 4;

FIG. 5 is a top plan view thereof; and,

FIG. 6 is a bottom plan view thereof.

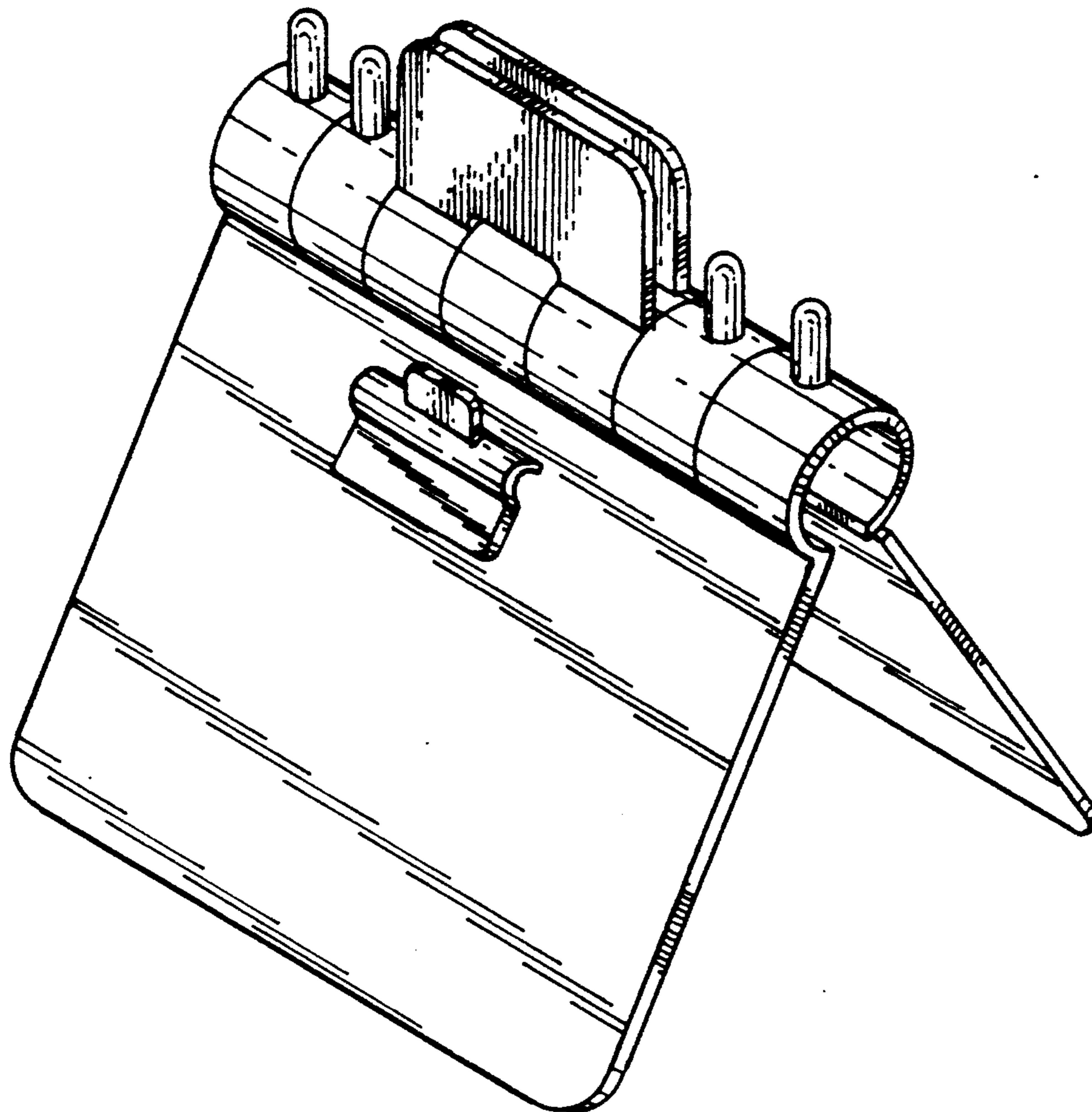

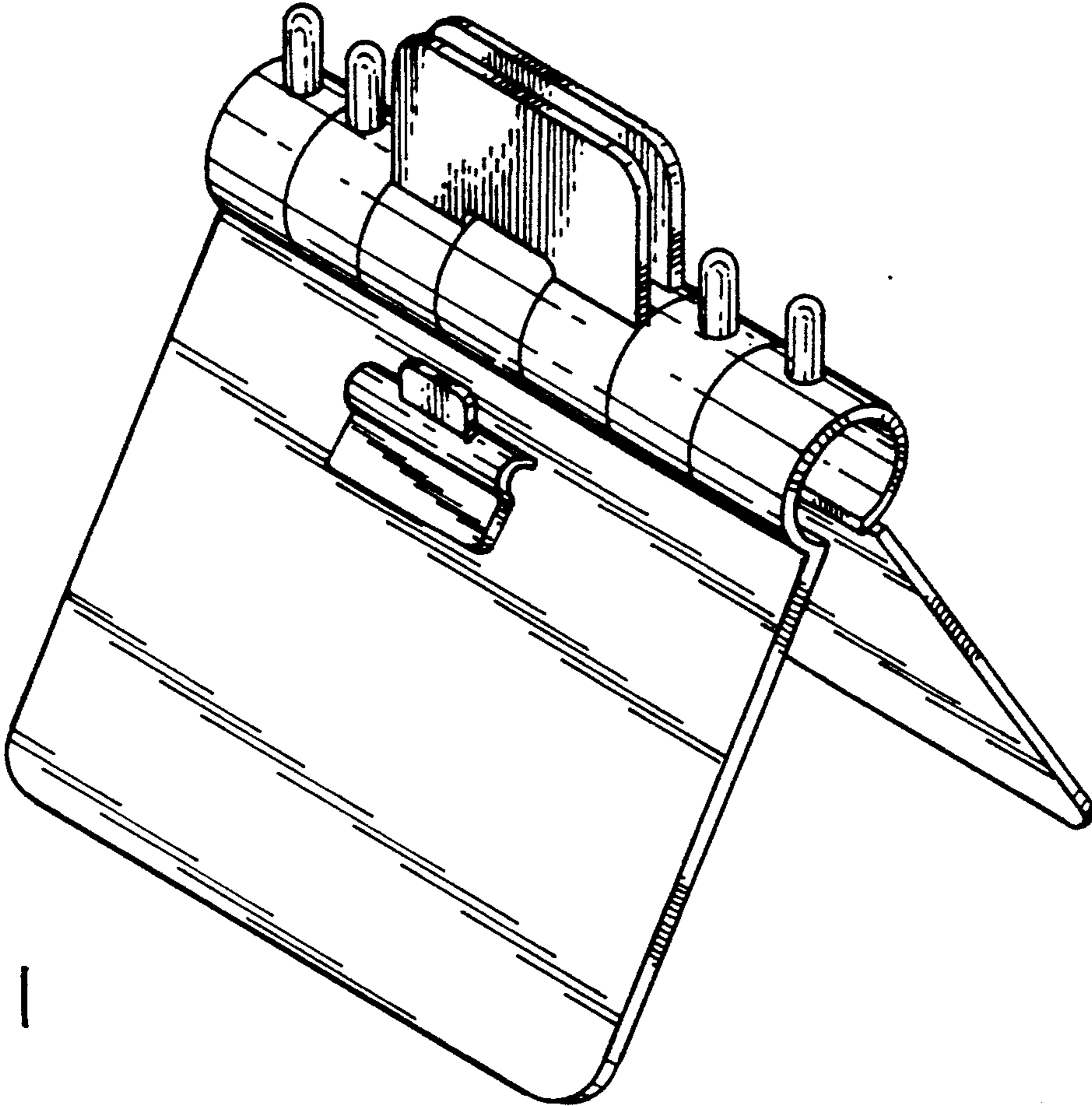

FIG. 1

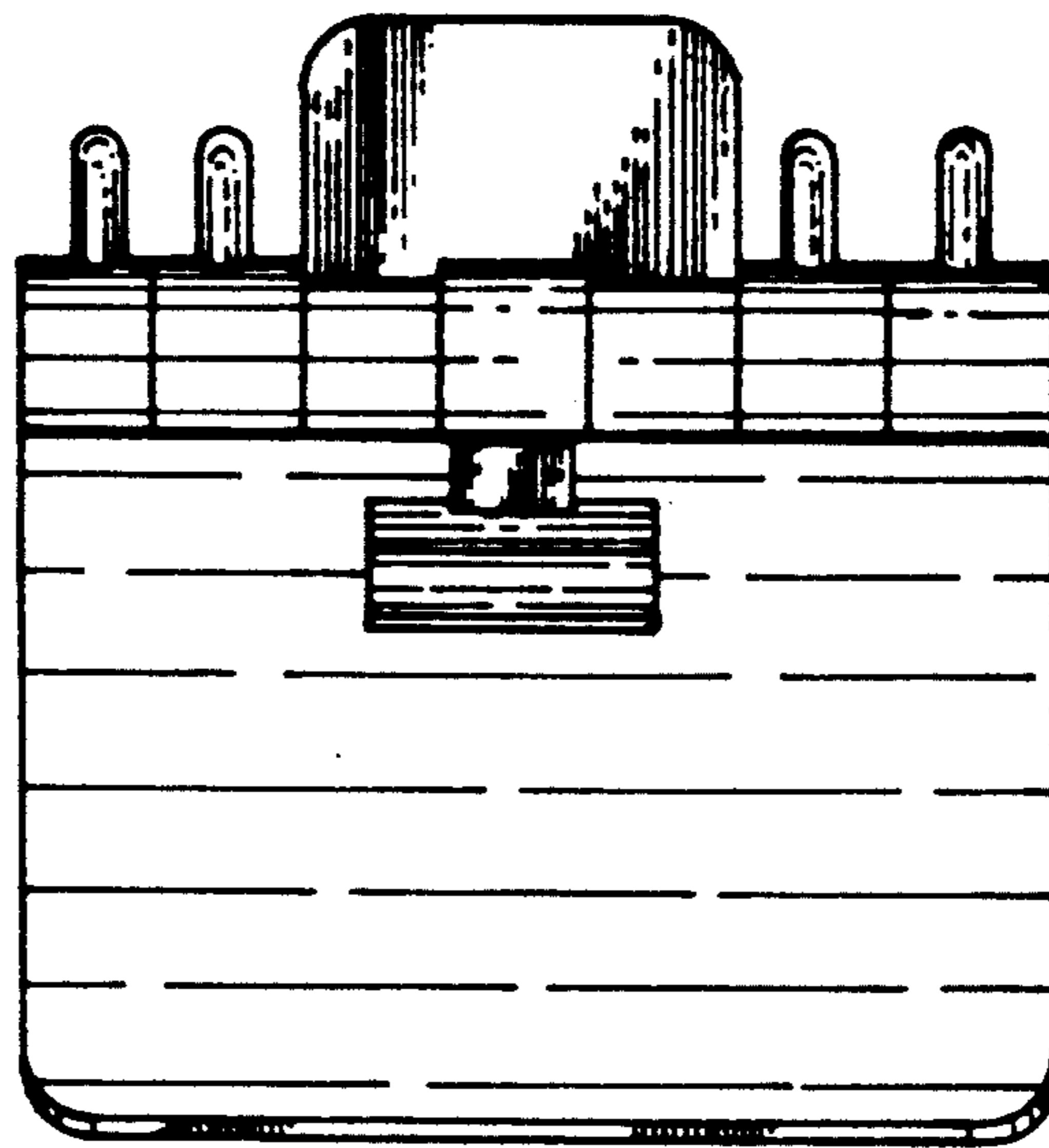

FIG. 2

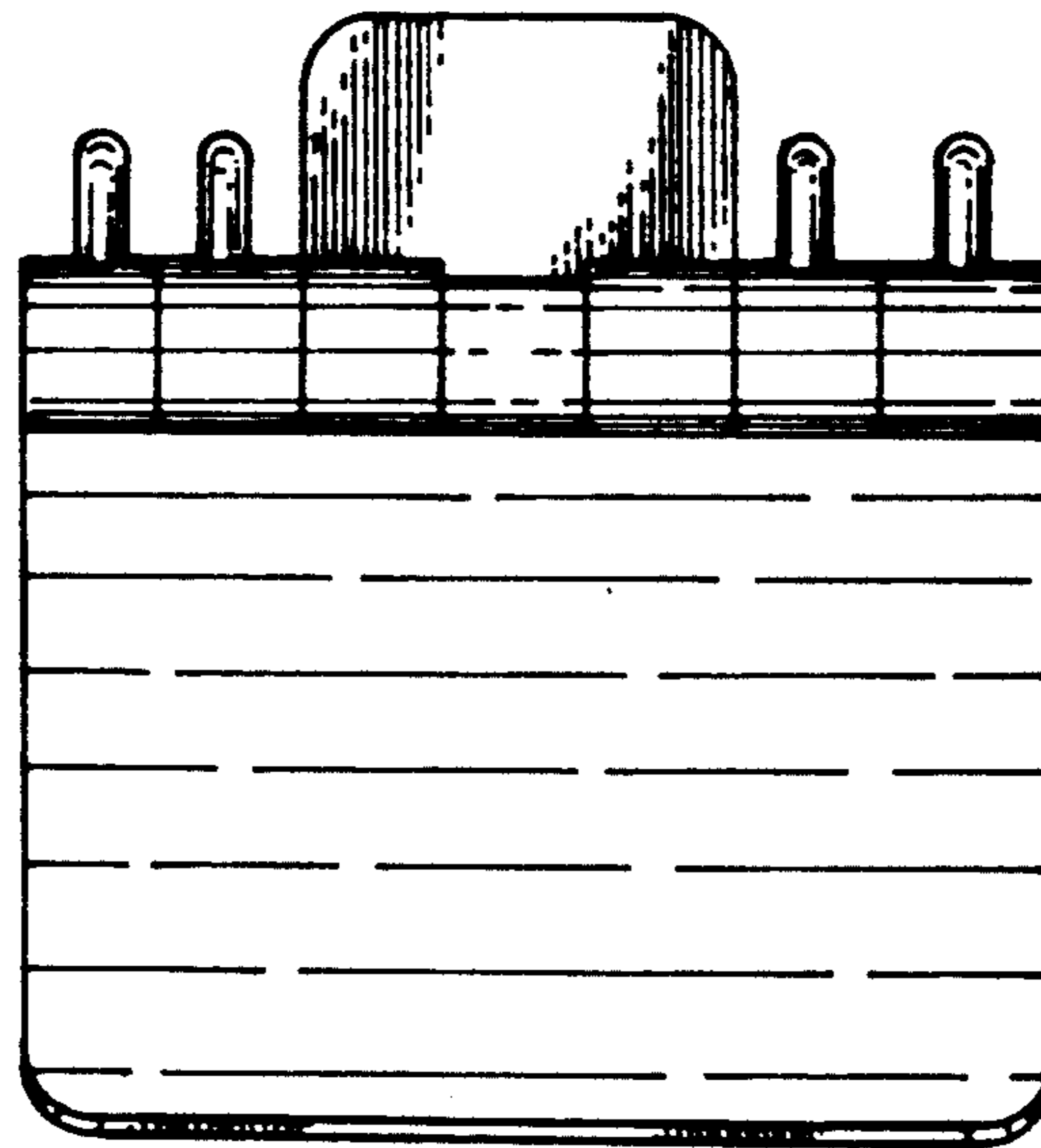

FIG. 3

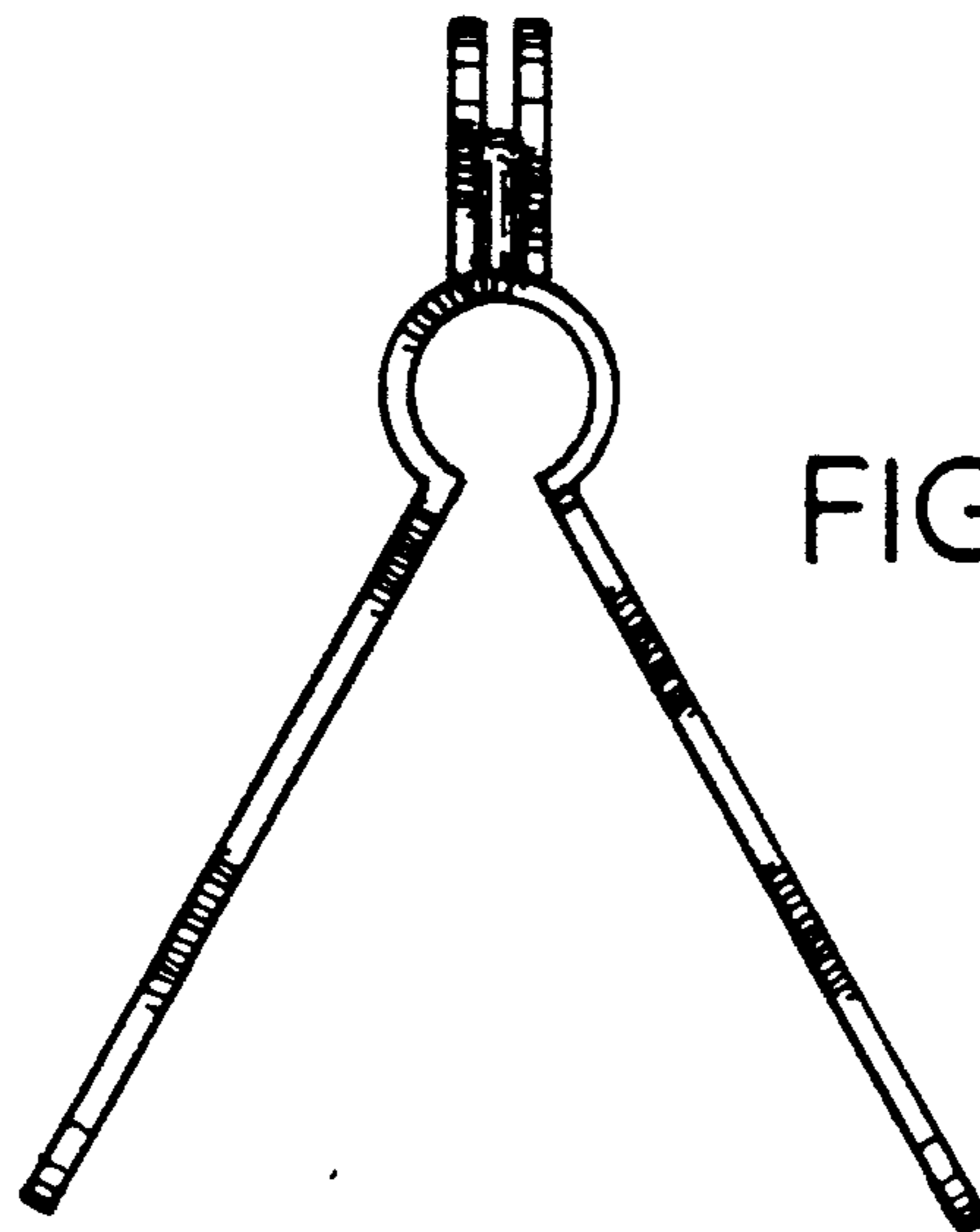

FIG. 4

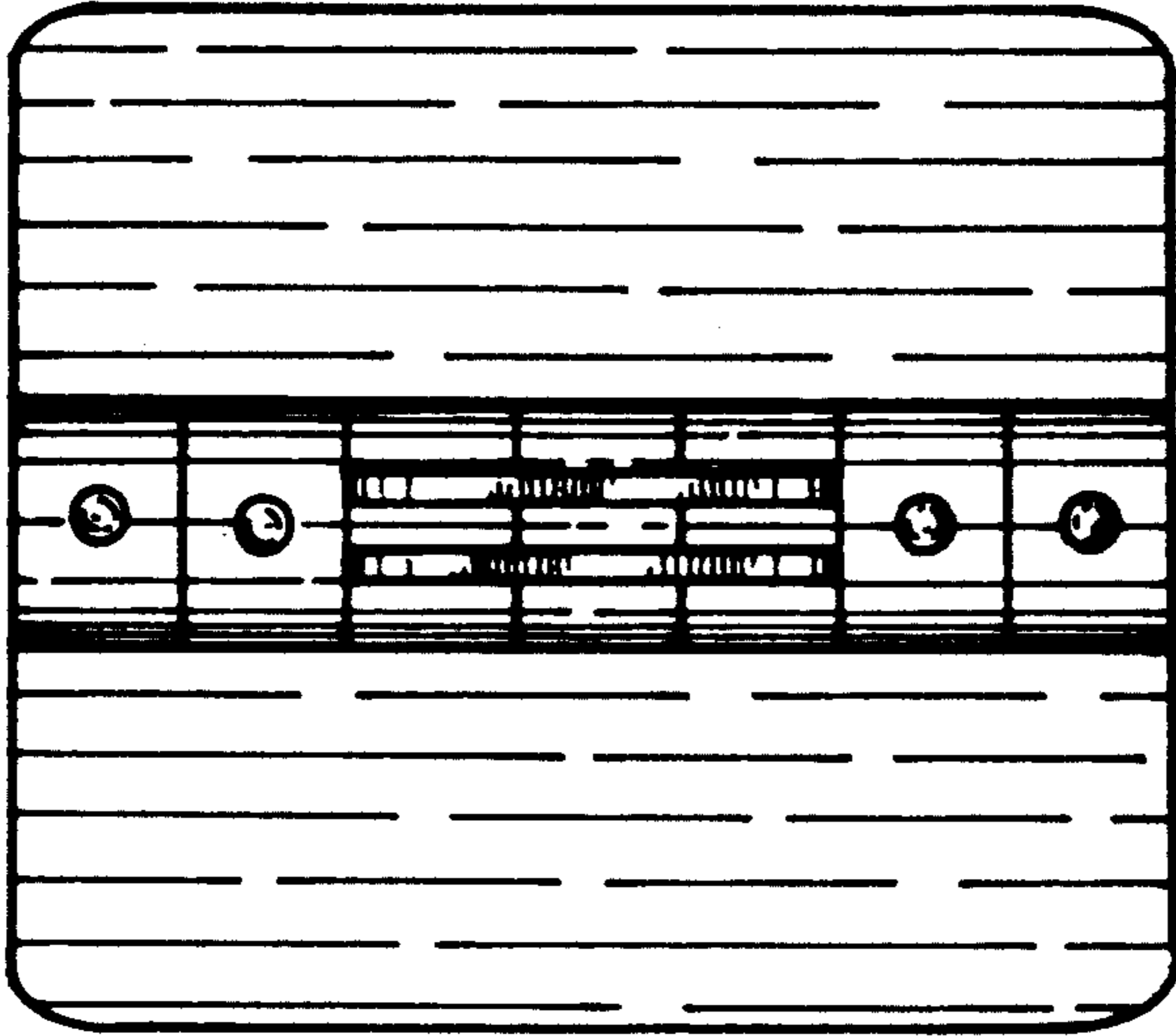

FIG. 5

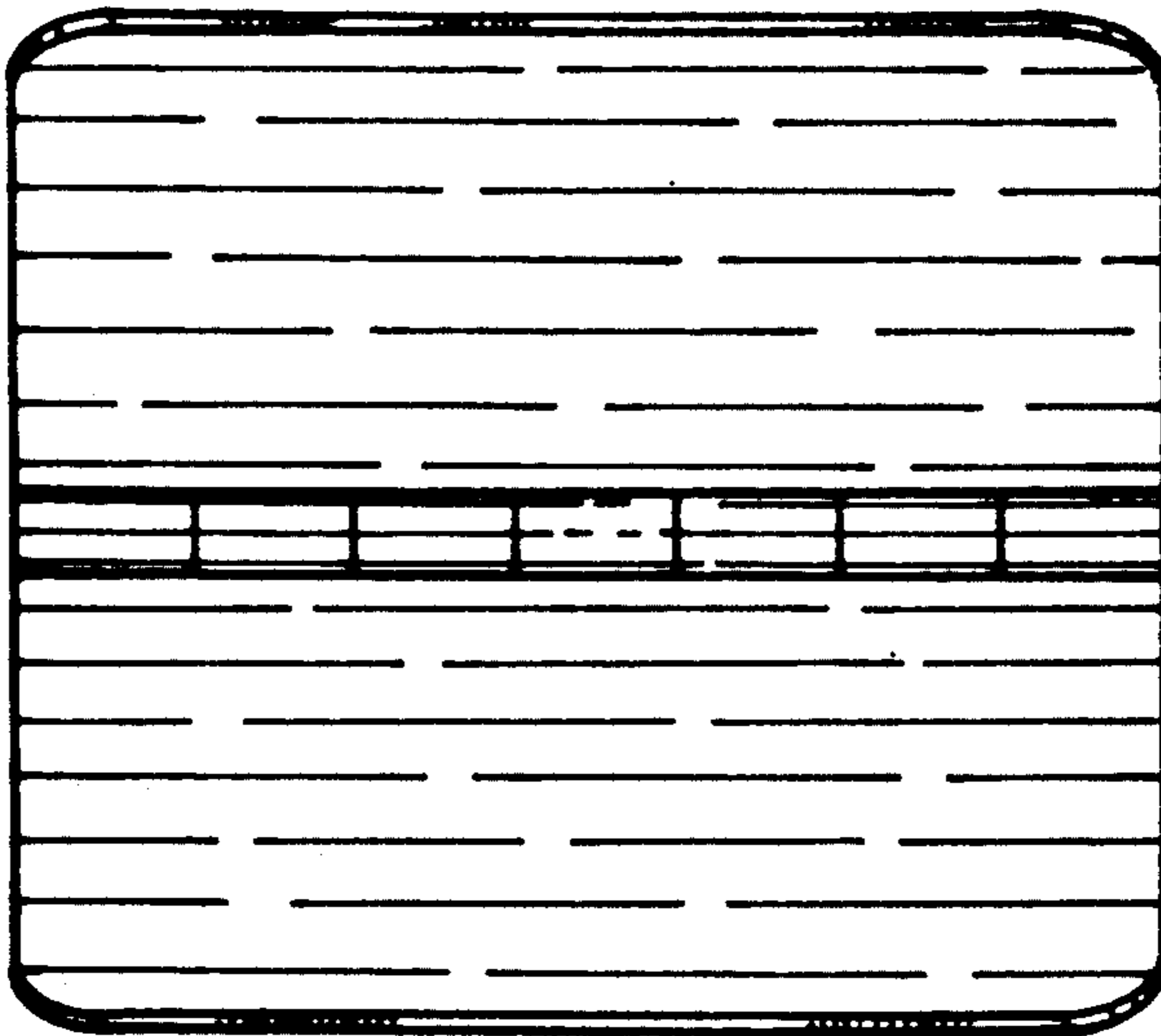

FIG. 6