



US00D348990S

United States Patent [19]

[11] Patent Number: **Des. 348,990**

Geiger et al.

[45] Date of Patent: **** Jul. 26, 1994**

[54] **CHAIR**

[75] Inventors: **John Geiger**, Atlanta, Ga.; **Douglas S. R. Lind**, Mississauga, Canada

[73] Assignee: **Geiger International, Inc.**, Atlanta, Ga.

[**] Term: **14 Years**

[21] Appl. No.: **772,038**

[22] Filed: **Oct. 7, 1991**

[52] U.S. Cl. **D6/366**

[58] Field of Search **D6/334, 365, 366, 374, D6/375, 379, 500, 501, 502; 297/411**

[56] **References Cited**

U.S. PATENT DOCUMENTS

D. 184,187	12/1958	McCarthy et al.	D6/366
D. 270,497	9/1983	Ochsner	D6/366
D. 273,251	4/1984	Petitt	D6/366
D. 278,391	4/1985	Platner	D6/366
D. 291,160	8/1987	Biscoe	D6/366
D. 297,600	9/1988	Wilson	D6/366 X

Primary Examiner—Alan P. Douglas

Assistant Examiner—Gary D. Watson
Attorney, Agent, or Firm—Hoffman, Wasson & Gitler

[57] **CLAIM**

The ornamental design for a chair, as shown and described.

DESCRIPTION

FIG. 1 is a perspective view of a chair;
 FIG. 2 is a right side view;
 FIG. 3 is a left side view;
 FIG. 4 is a top view;
 FIG. 5 is a bottom view;
 FIG. 6 is a front view;
 FIG. 7 is a back view;
 FIG. 8 is a perspective view of a chair showing a second embodiment of my new design;
 FIG. 9 is a right side view of FIG. 8;
 FIG. 10 is a left side view of FIG. 8;
 FIG. 11 is a top view of FIG. 8;
 FIG. 12 is a bottom view of FIG. 8;
 FIG. 13 is a front view of FIG. 8; and,
 FIG. 14 is a back view of FIG. 8.
 The broken line showing in all views represents stitching.

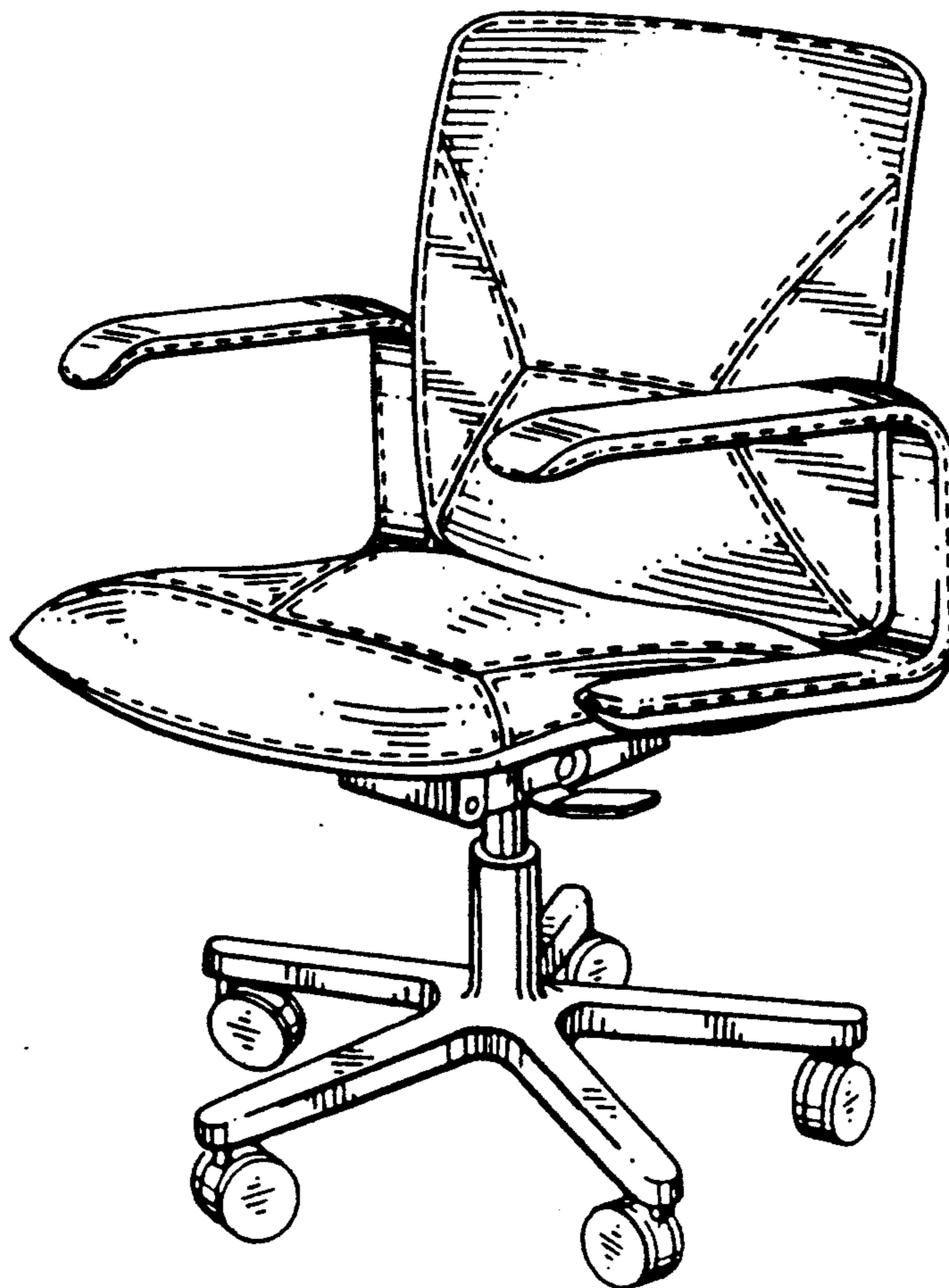

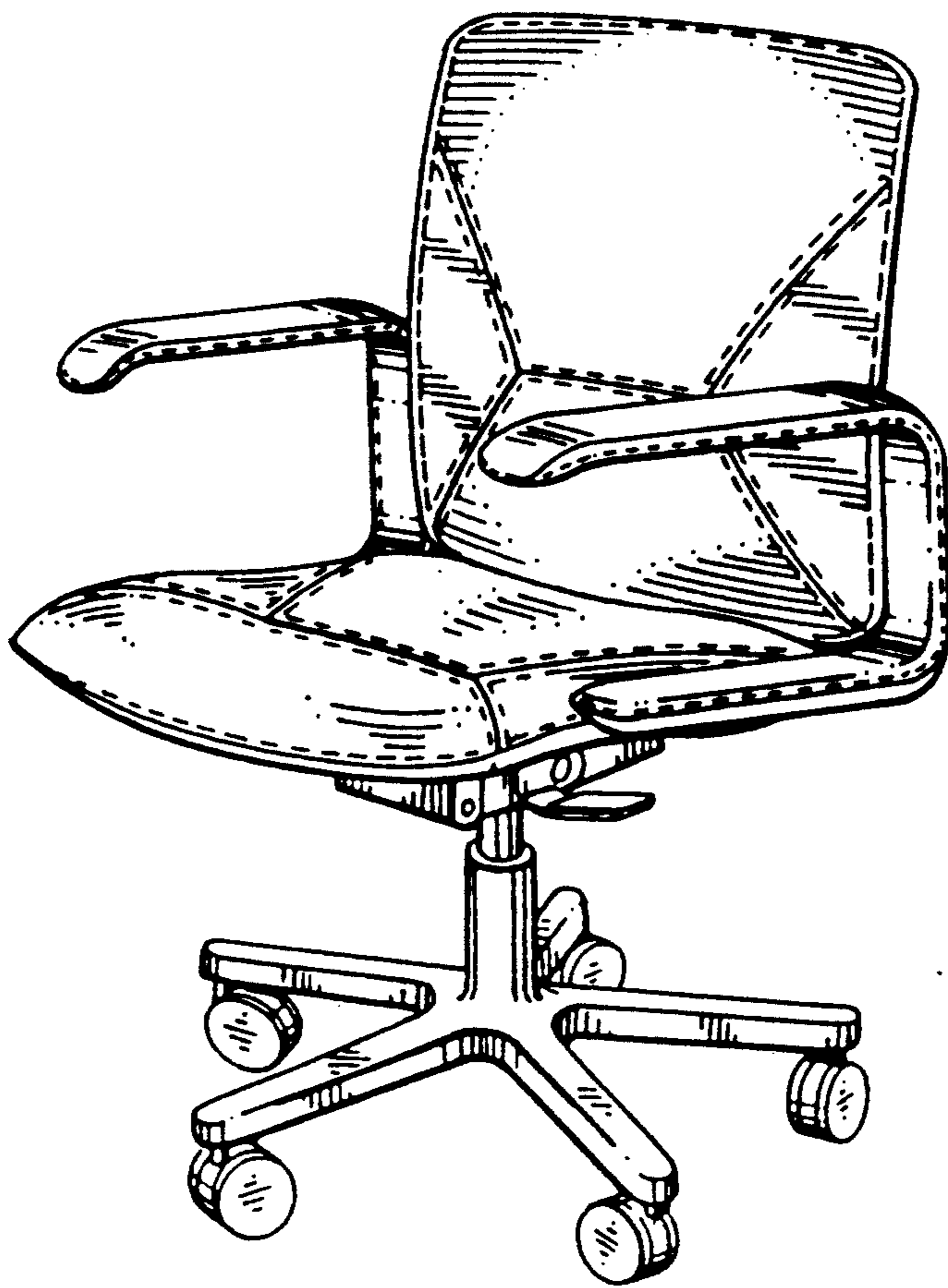

FIG. 1

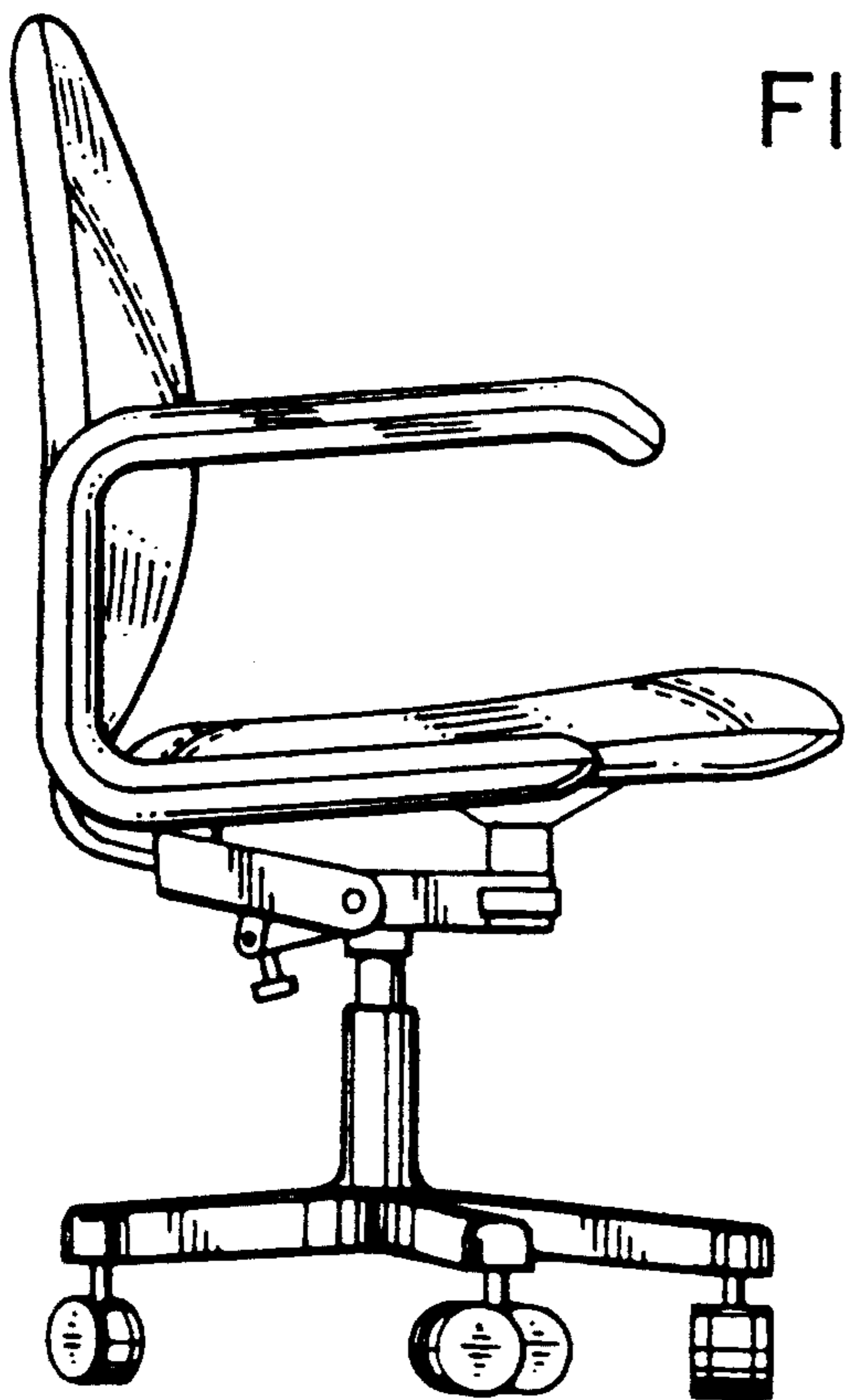

FIG. 2

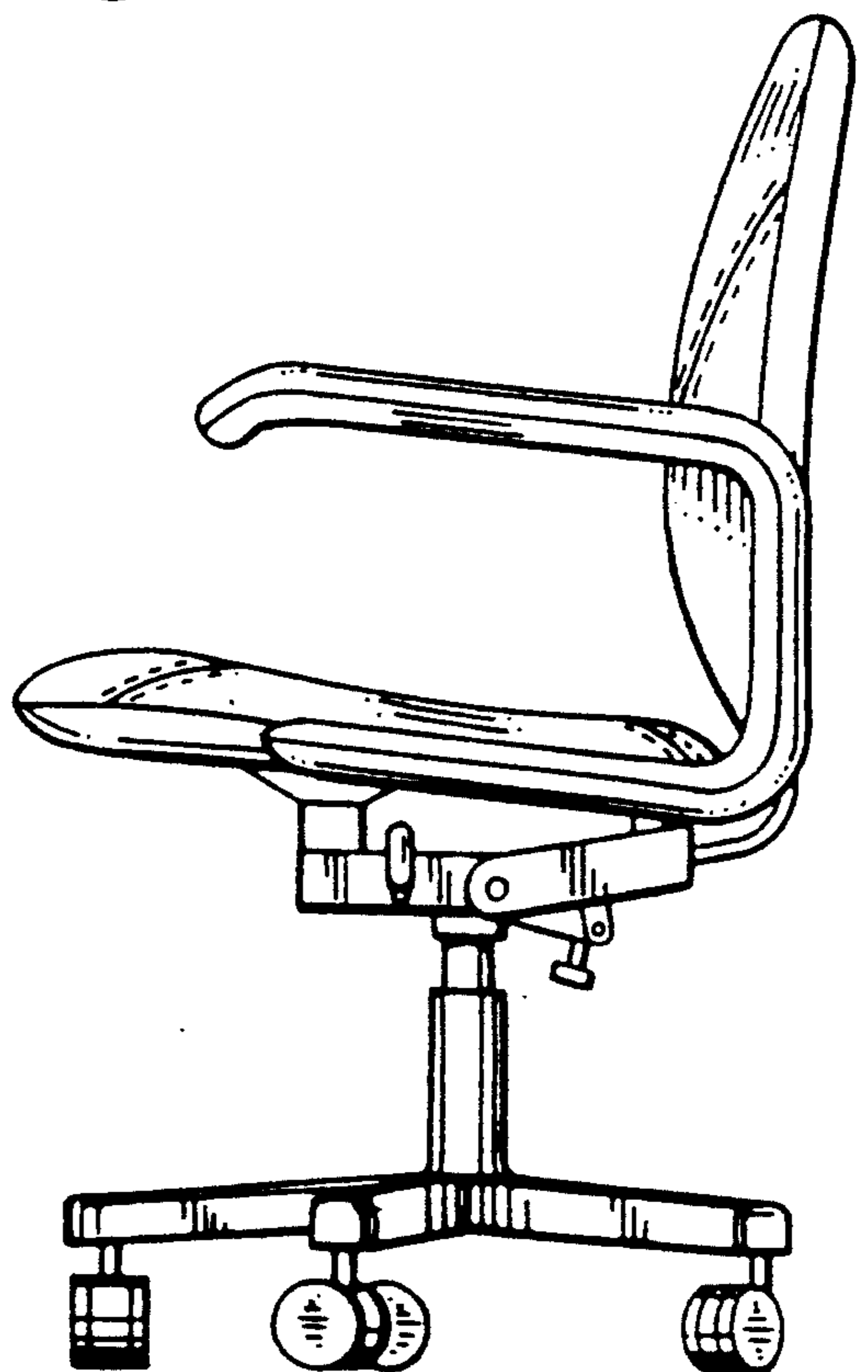

FIG. 3

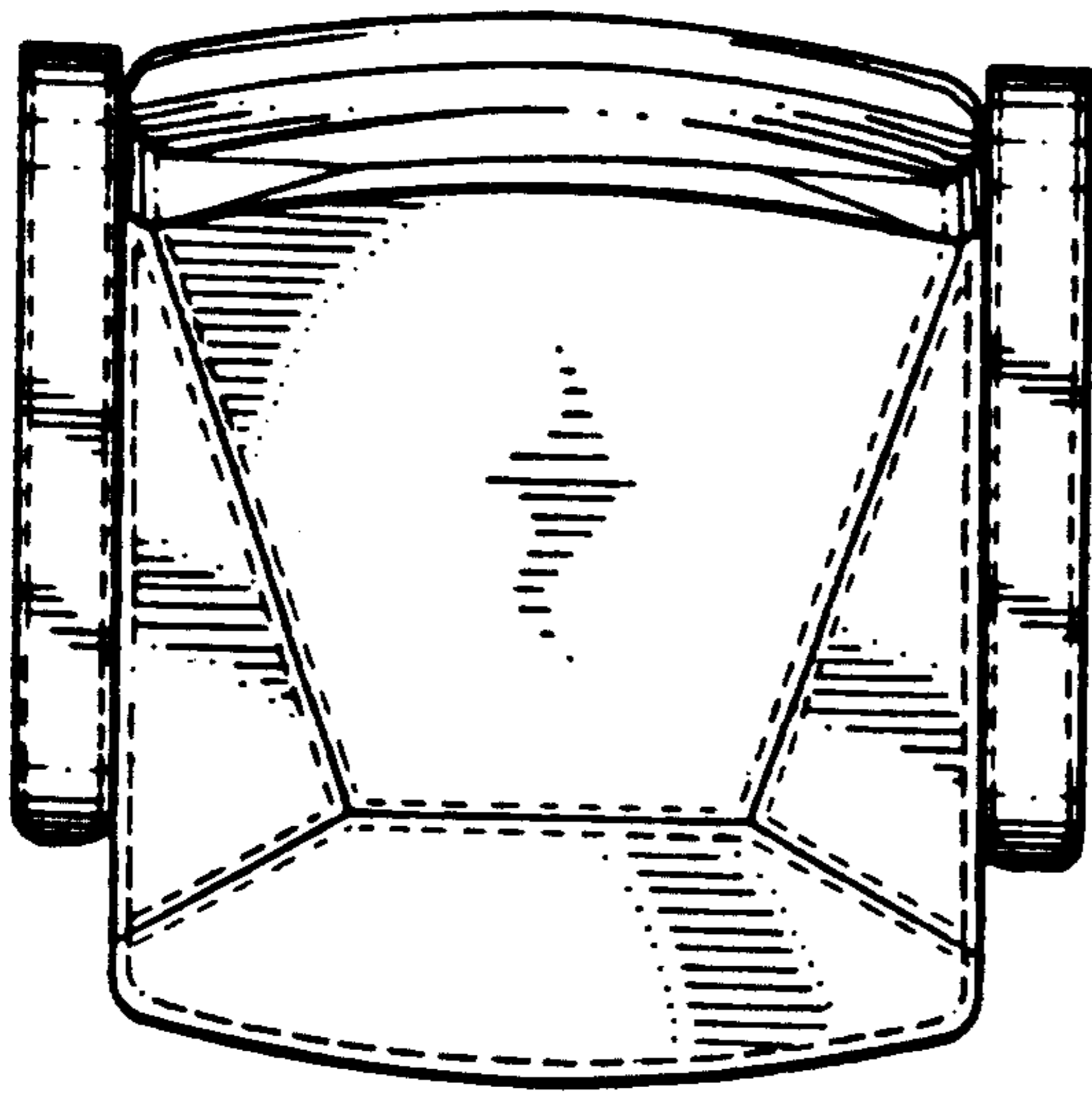

FIG. 4

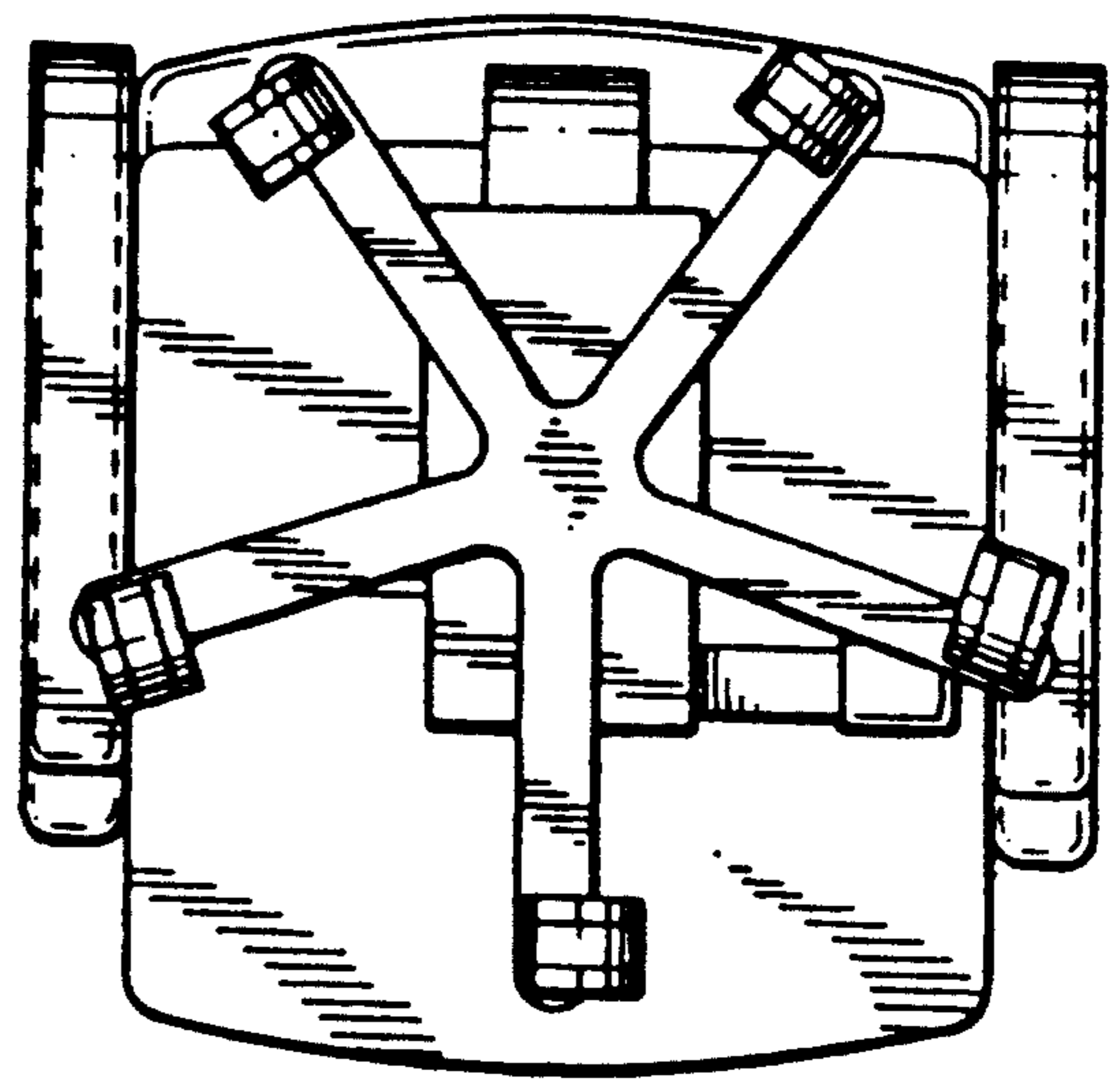

FIG. 5

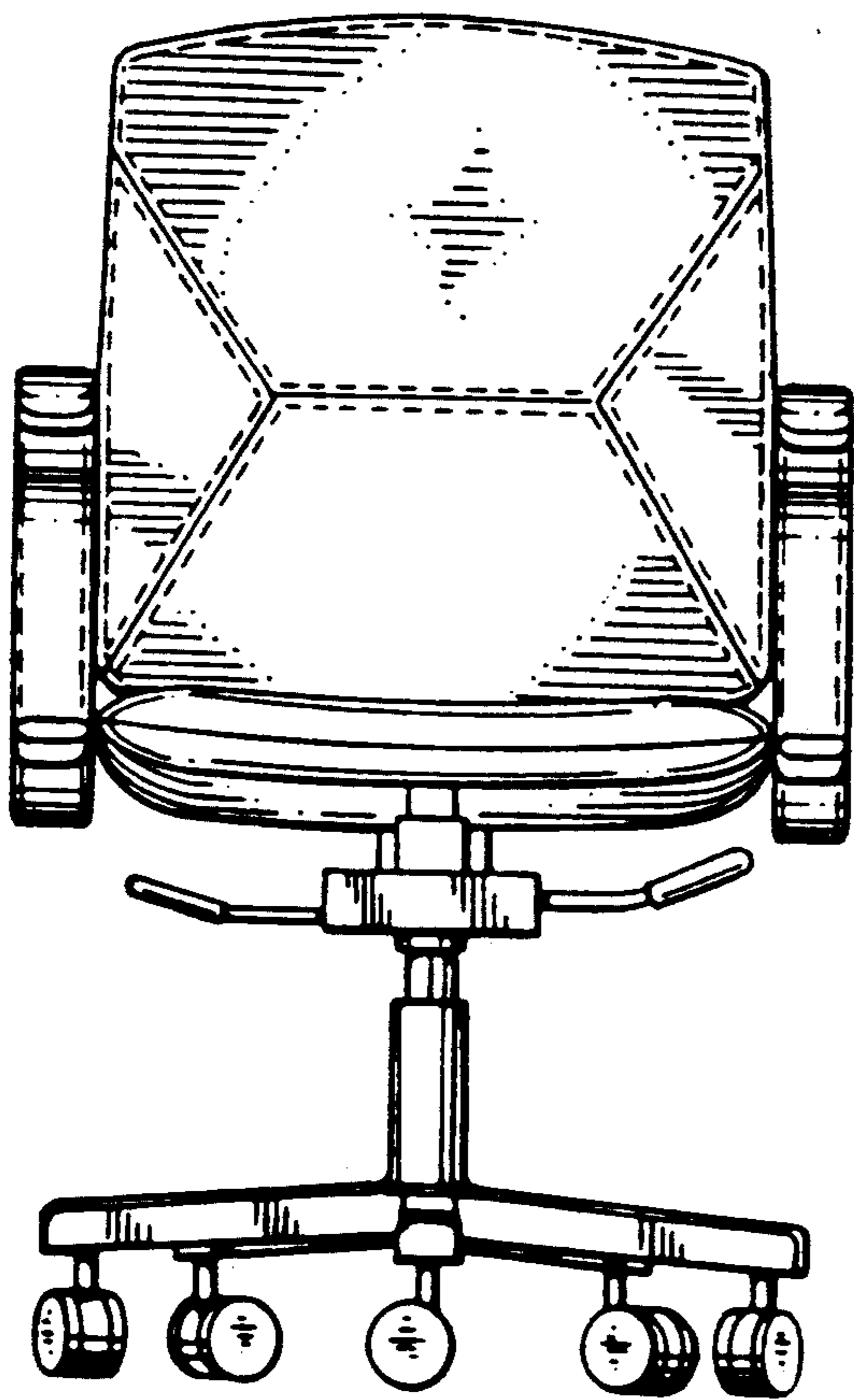

FIG. 6

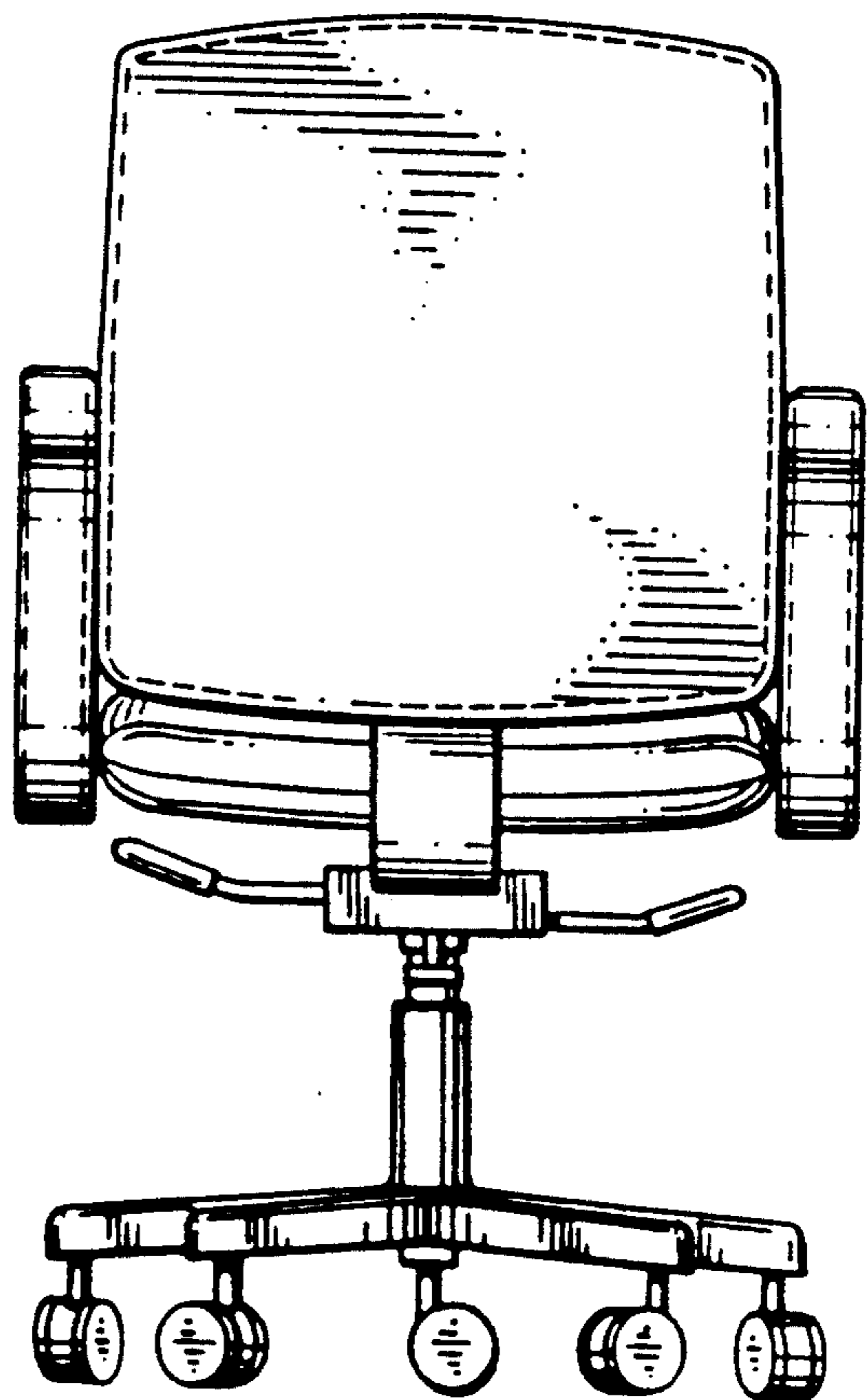

FIG. 7

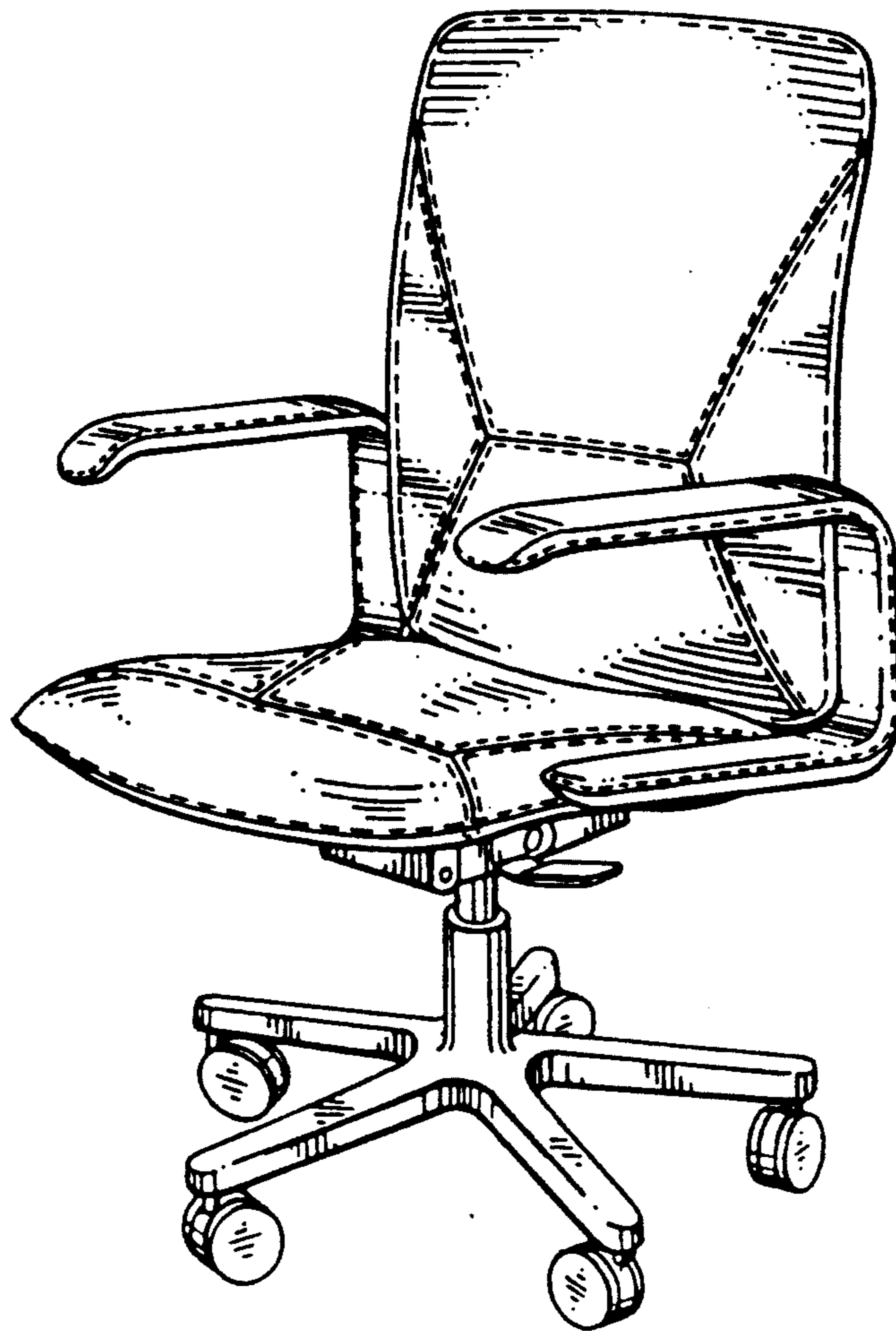

FIG. 8

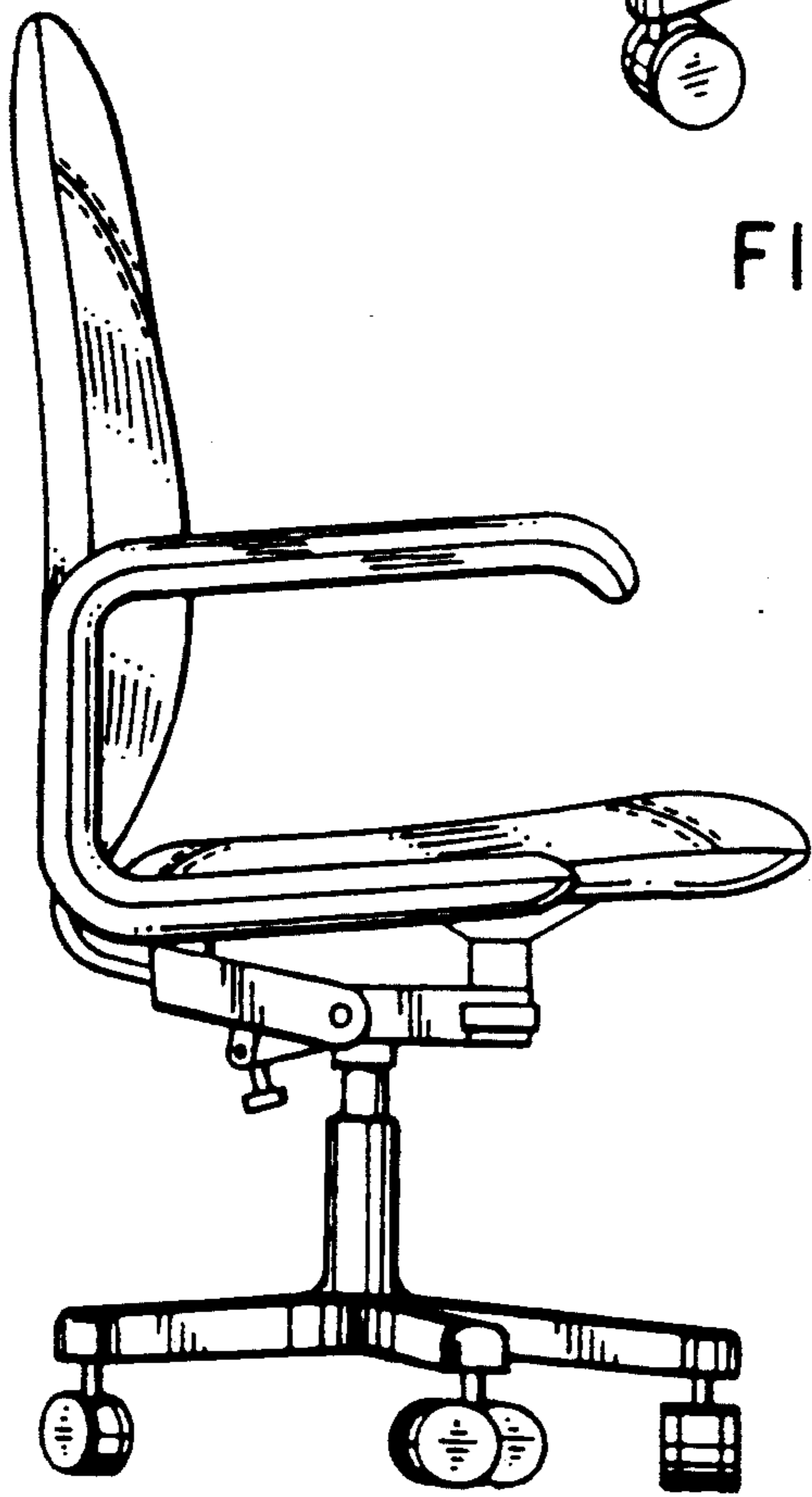

FIG. 9

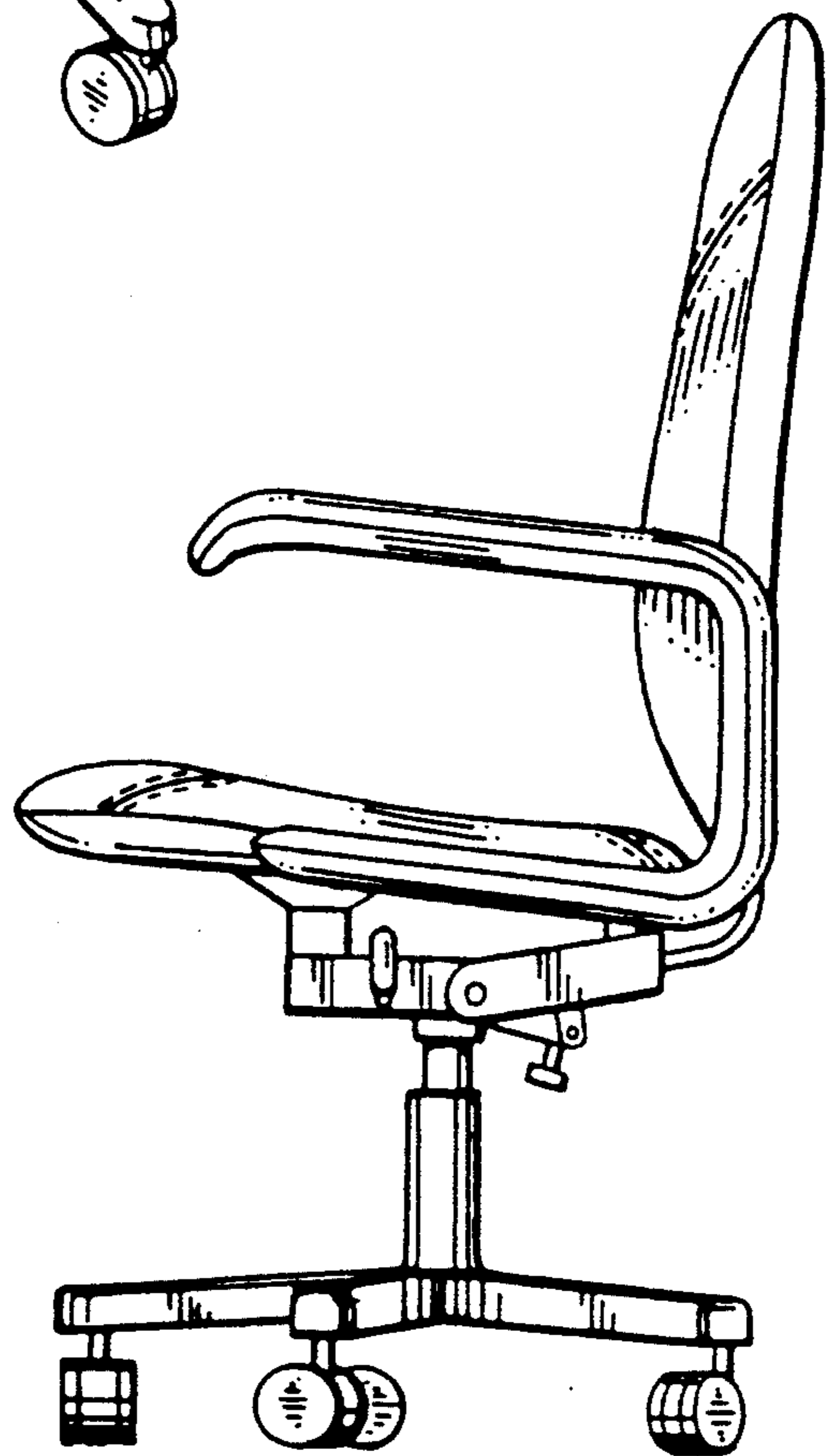

FIG. 10

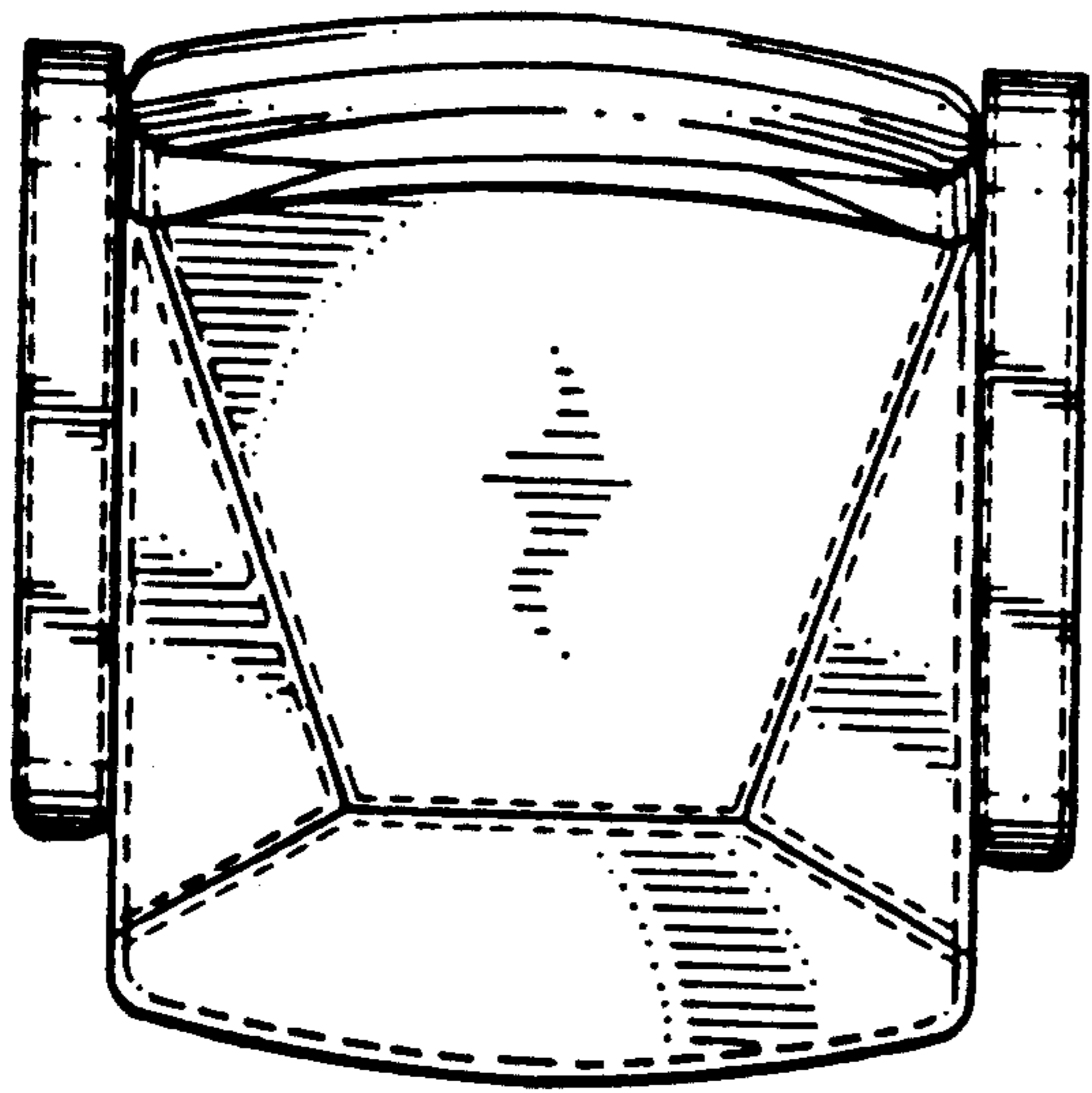

FIG. 11

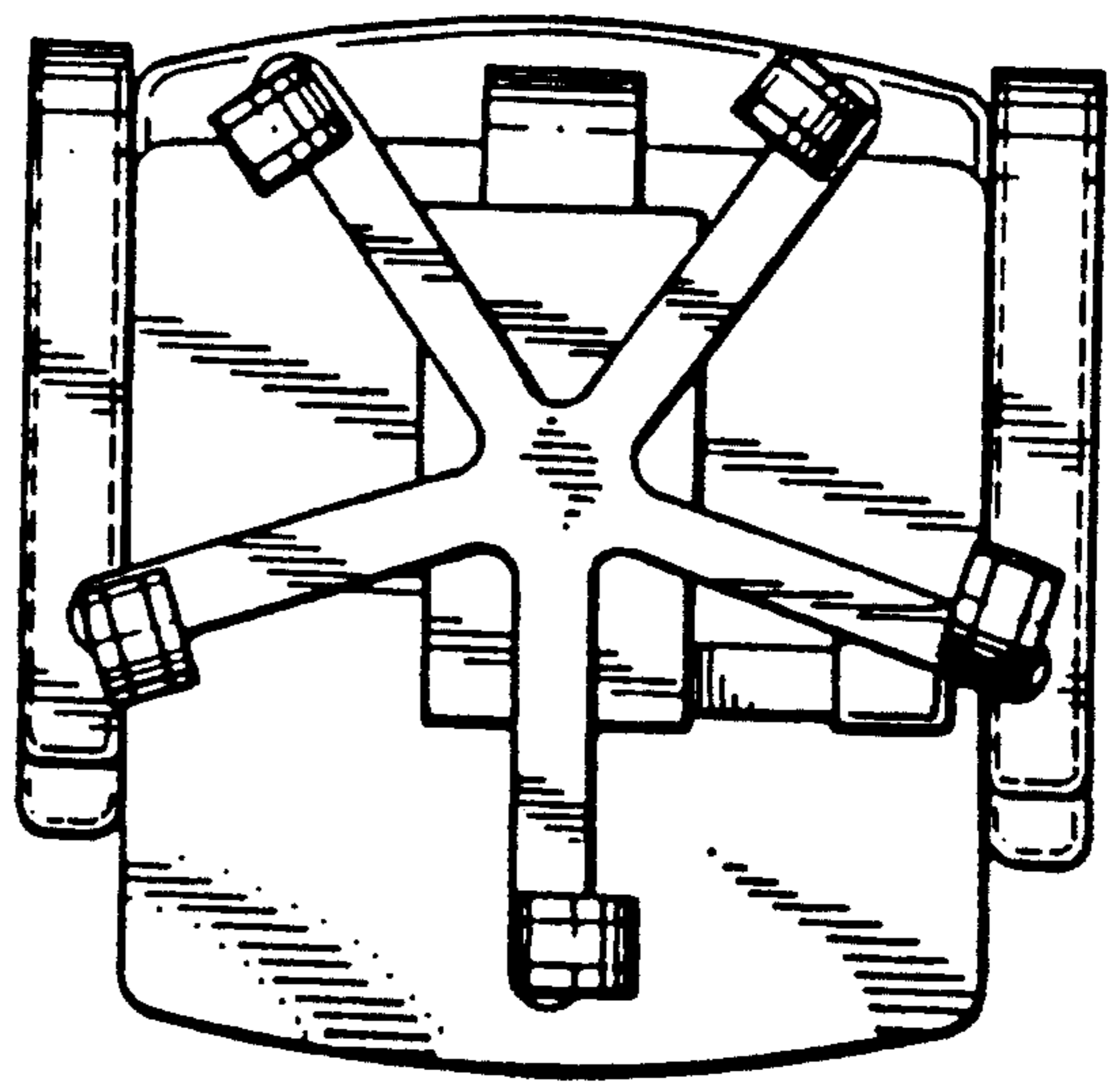

FIG. 12

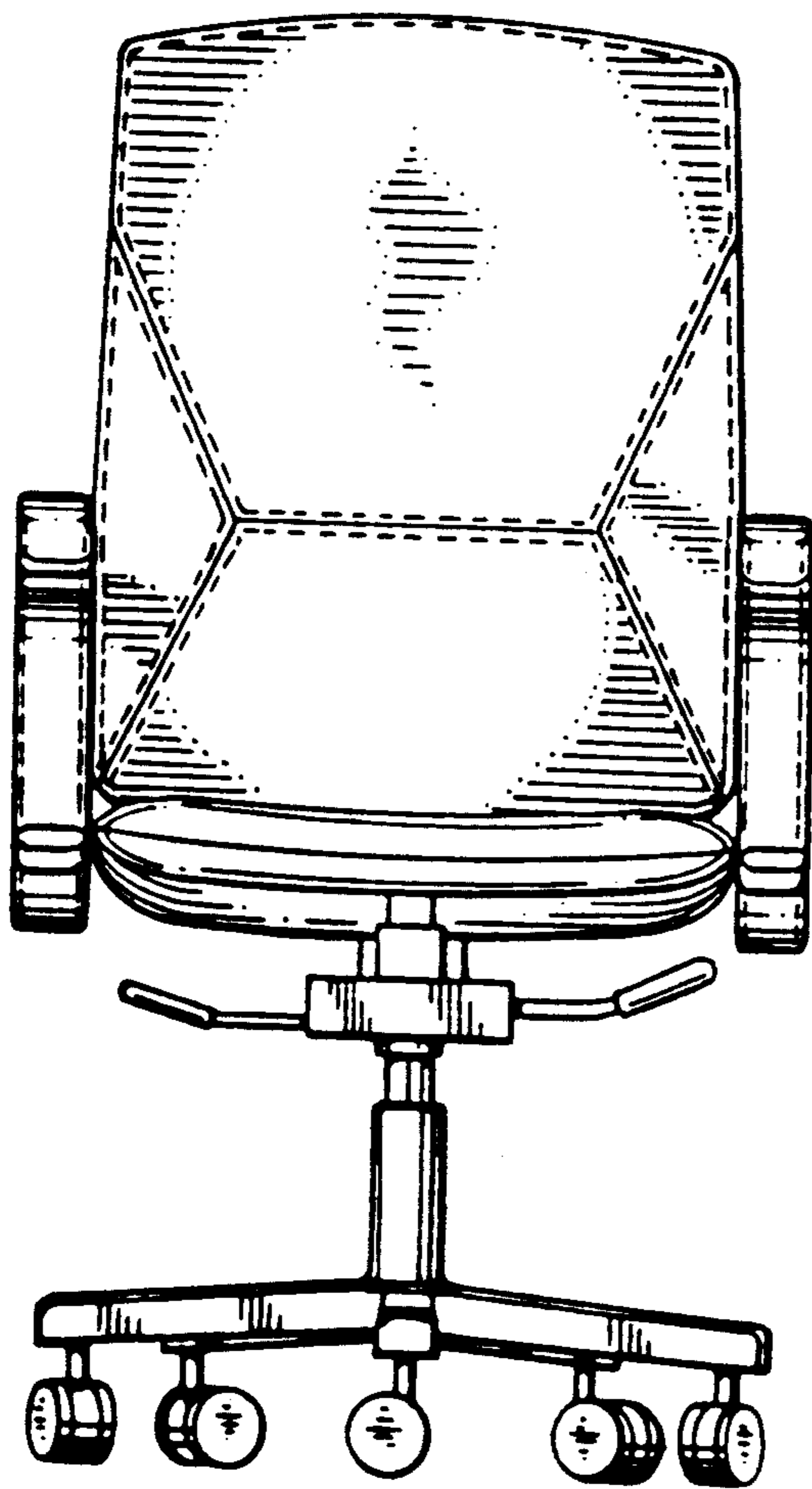

FIG. 13

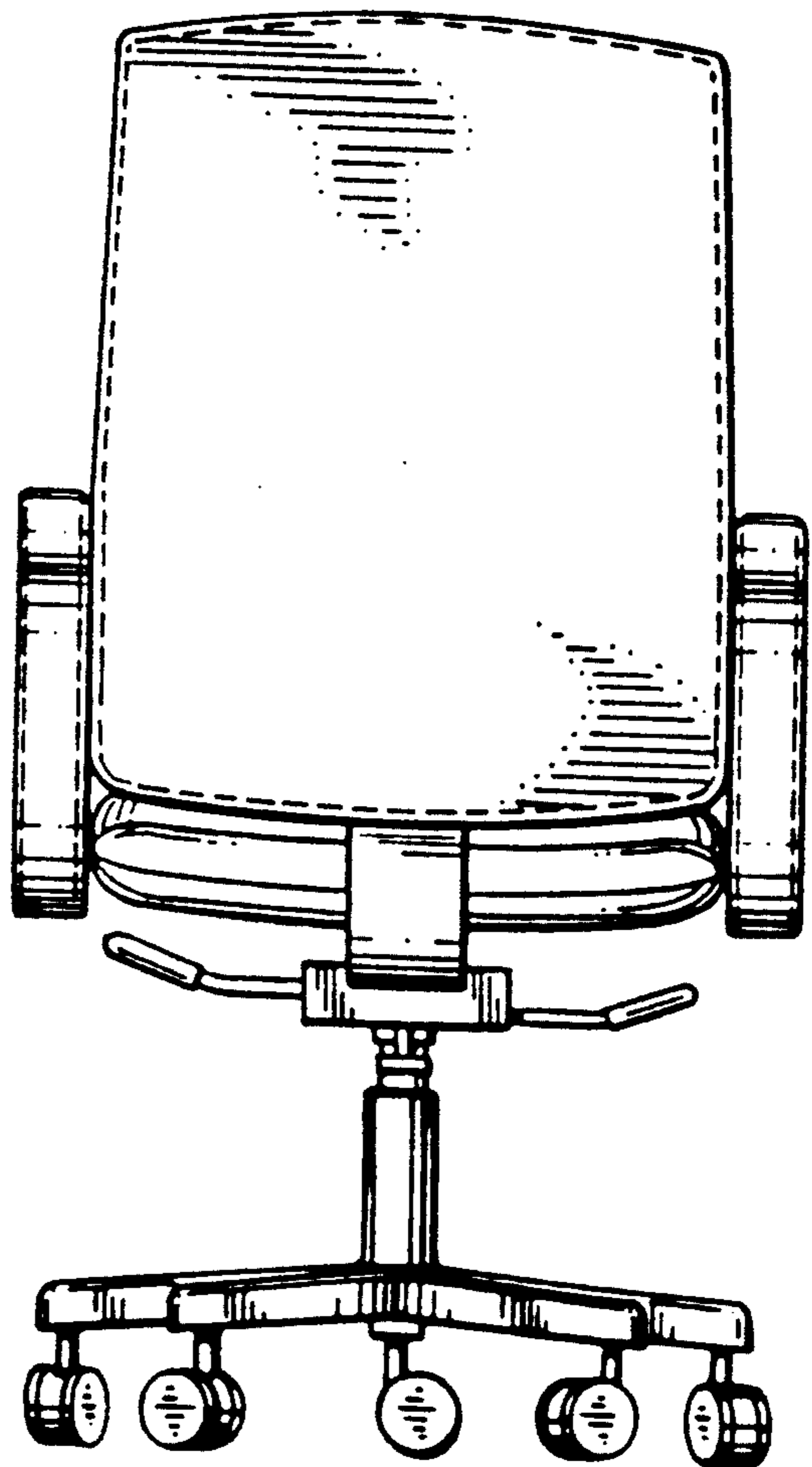

FIG. 14