



US00D348964S

United States Patent [19]

[11] Patent Number: **Des. 348,964**

Roy et al.

[45] Date of Patent: **** Jul. 19, 1994**

[54] **CONTAINER FOR SEGREGATING WASTE MATERIALS**

1296691 5/1989 Canada .
2045370 6/1991 Canada .
2047542 7/1991 Canada .
2047998 7/1991 Canada .
3024822 1/1980 Fed. Rep. of Germany .

[75] Inventors: **Pierre J. Roy, Lenoxville; Denis Houle, Blainville, both of Canada**

[73] Assignee: **Nova Sylva Inc., Canada**

Primary Examiner—Kay H. Chin
Attorney, Agent, or Firm—Lerner, David, Littenberg, Krumholz & Mentlik

[**] Term: **14 Years**

[21] Appl. No.: **2,551**

[57] **CLAIM**

[22] Filed: **Dec. 11, 1992**

The ornamental design for a container for segregating waste materials, as shown and described.

[52] U.S. Cl. **D34/7; D34/1**

[58] Field of Search 220/908, 909, 23.83, 220/23.2, 23.4, 23.6; D34/1, 7, 9, 11

DESCRIPTION

[56] **References Cited**

U.S. PATENT DOCUMENTS

- D. 319,904 9/1991 Cozzi et al. D34/7
- 4,176,747 12/1979 Aho 220/23.83
- 4,428,493 1/1984 McDonough .
- 4,660,758 4/1987 Tavel et al. .
- 4,715,572 12/1987 Robbins, III et al. .
- 4,729,489 3/1988 Papaiani .
- 4,739,894 4/1988 Pender .
- 4,750,639 6/1988 Schaerer .
- 4,801,034 1/1989 Sandomeno .
- 4,823,955 4/1989 Apps .
- 4,834,253 5/1989 Crine .
- 4,860,910 8/1989 Zipper .
- 4,878,592 11/1989 Lee .
- 4,893,719 1/1990 Lombardi et al. .
- 4,893,722 1/1990 Jones .
- 4,940,159 7/1990 Callas et al. .
- 5,022,548 6/1991 Stakis .
- 5,062,539 11/1991 Chandler 220/909
- 5,092,480 3/1992 Waterston .

FOREIGN PATENT DOCUMENTS

1104627 10/1978 Canada .

FIG. 1 is a front perspective view of a container for segregating waste materials showing our new design; FIG. 2 is a front elevational view thereof; FIG. 3 is a rear elevational view thereof; FIG. 4 is a right side elevational view thereof, the left side view being identical; FIG. 5 is a top plan view thereof; FIG. 6 is a bottom plan view thereof; FIG. 7 is a front perspective view of a second embodiment of the container for segregating waste materials; FIG. 8 is a front elevational view of FIG. 7; FIG. 9 is a rear elevational view of FIG. 7; FIG. 10 is a right side elevational view of FIG. 7, the left side view being identical; FIG. 11 is a top plan view of FIG. 7; FIG. 12 is a bottom plan view of FIG. 7; FIG. 13 is a front perspective view of FIG. 1 in partial unassembled condition; FIG. 14 is a front elevational view of FIG. 13; FIG. 15 is a rear elevational view of FIG. 13; FIG. 16 is a right side elevational view of FIG. 13, the left side view being identical; FIG. 17 is a top plan view of FIG. 13; and, FIG. 18 is a bottom plan view of FIG. 13.

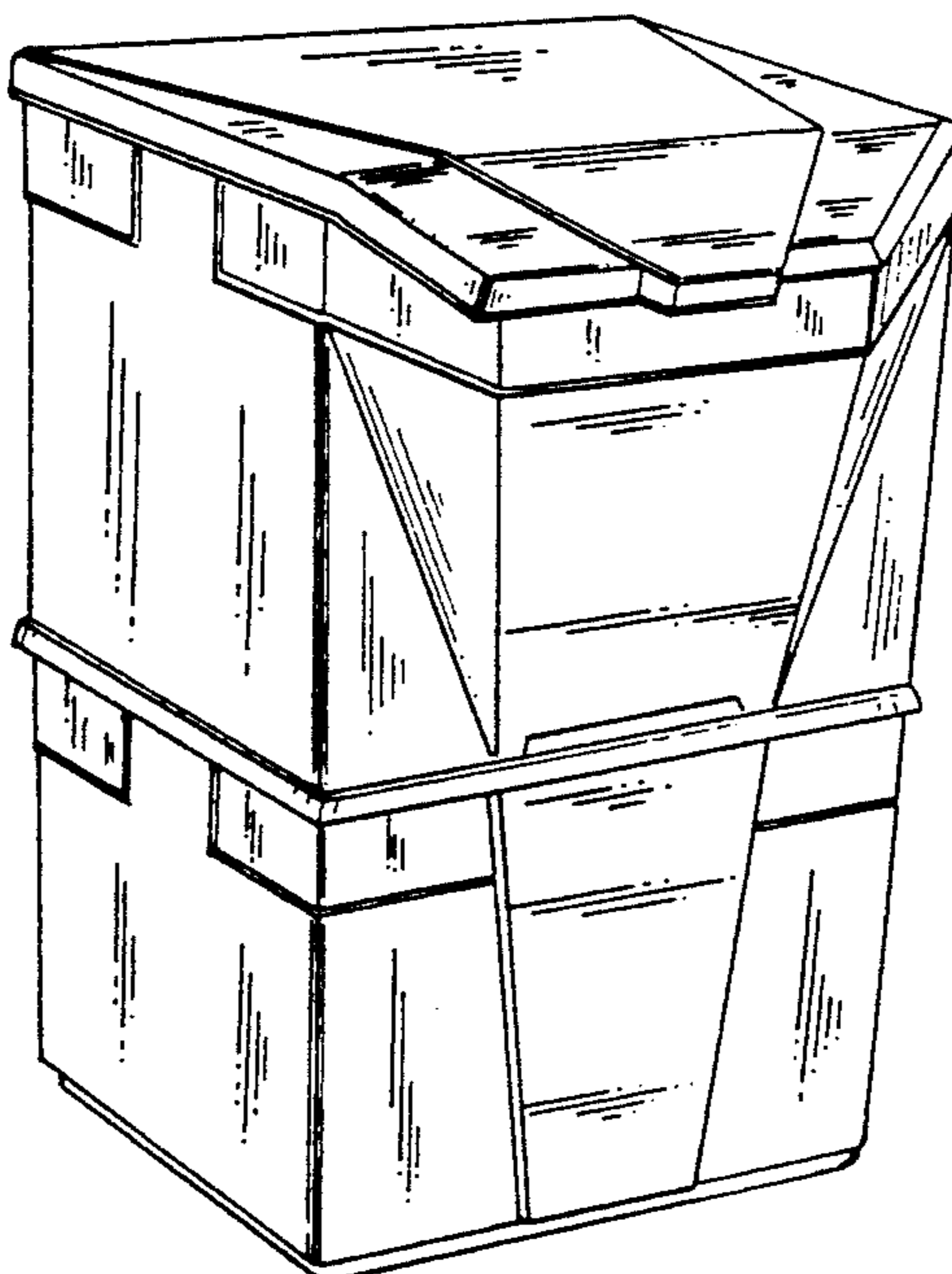

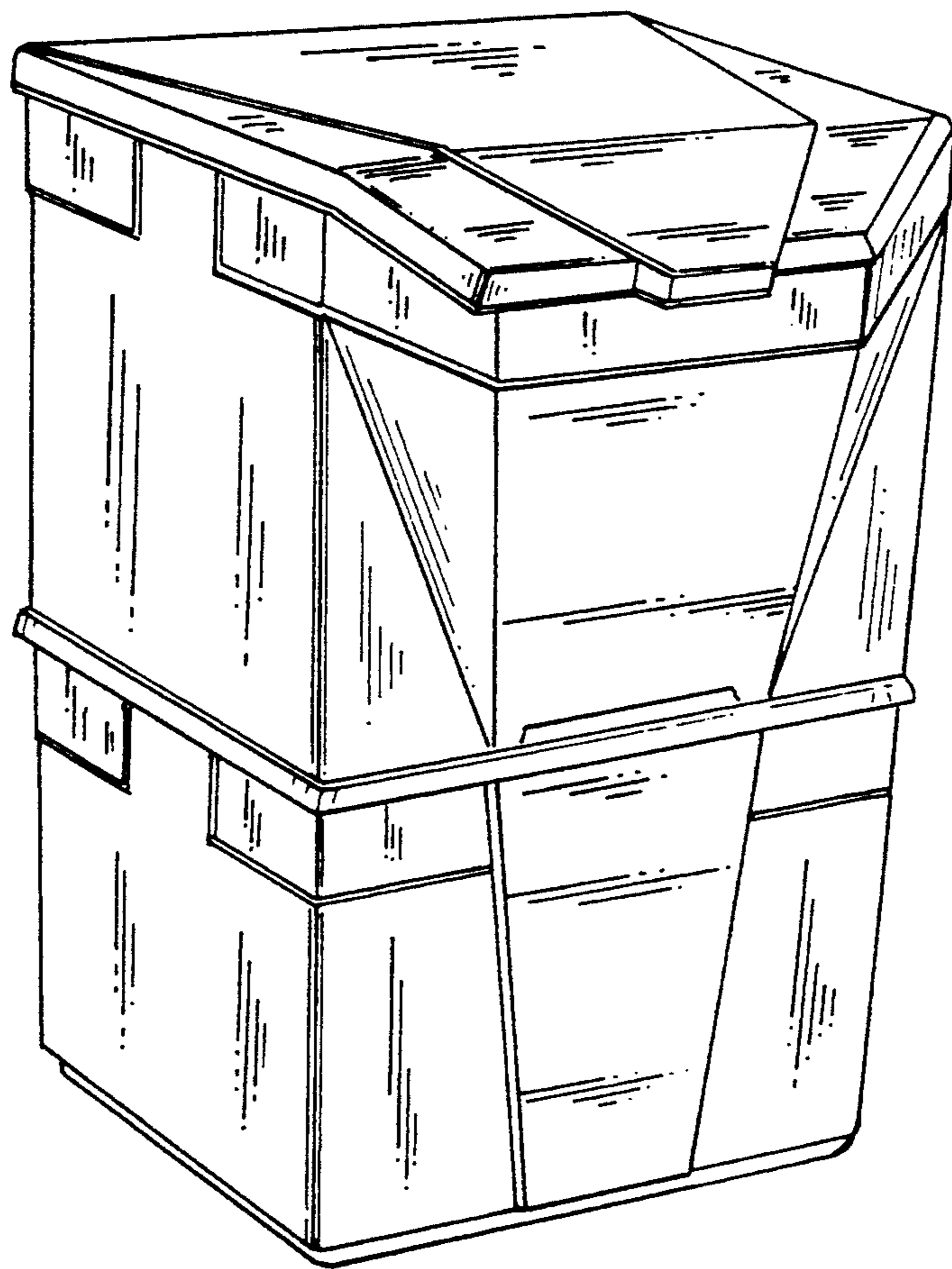

FIG. 1

FIG. 2

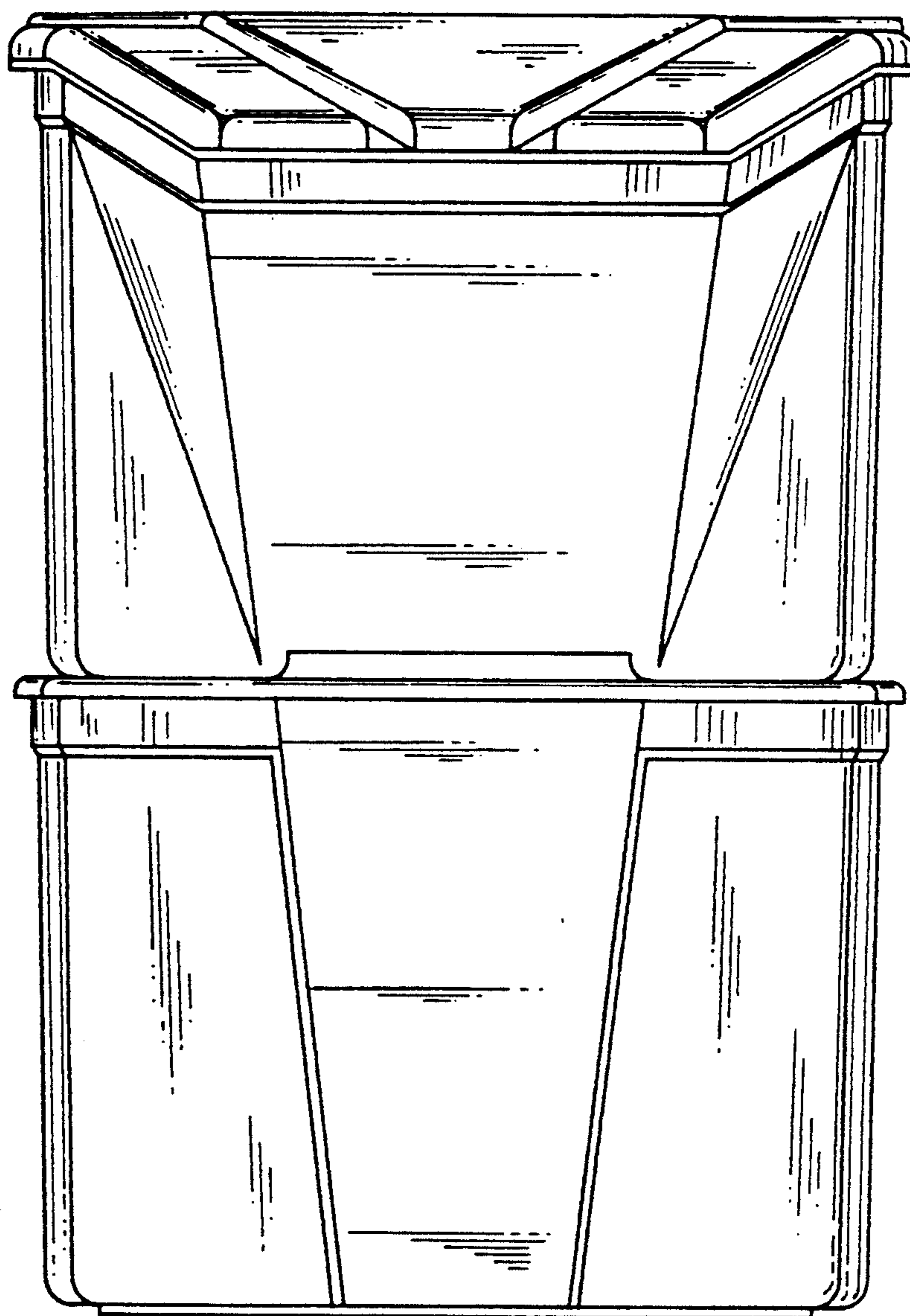

FIG. 3

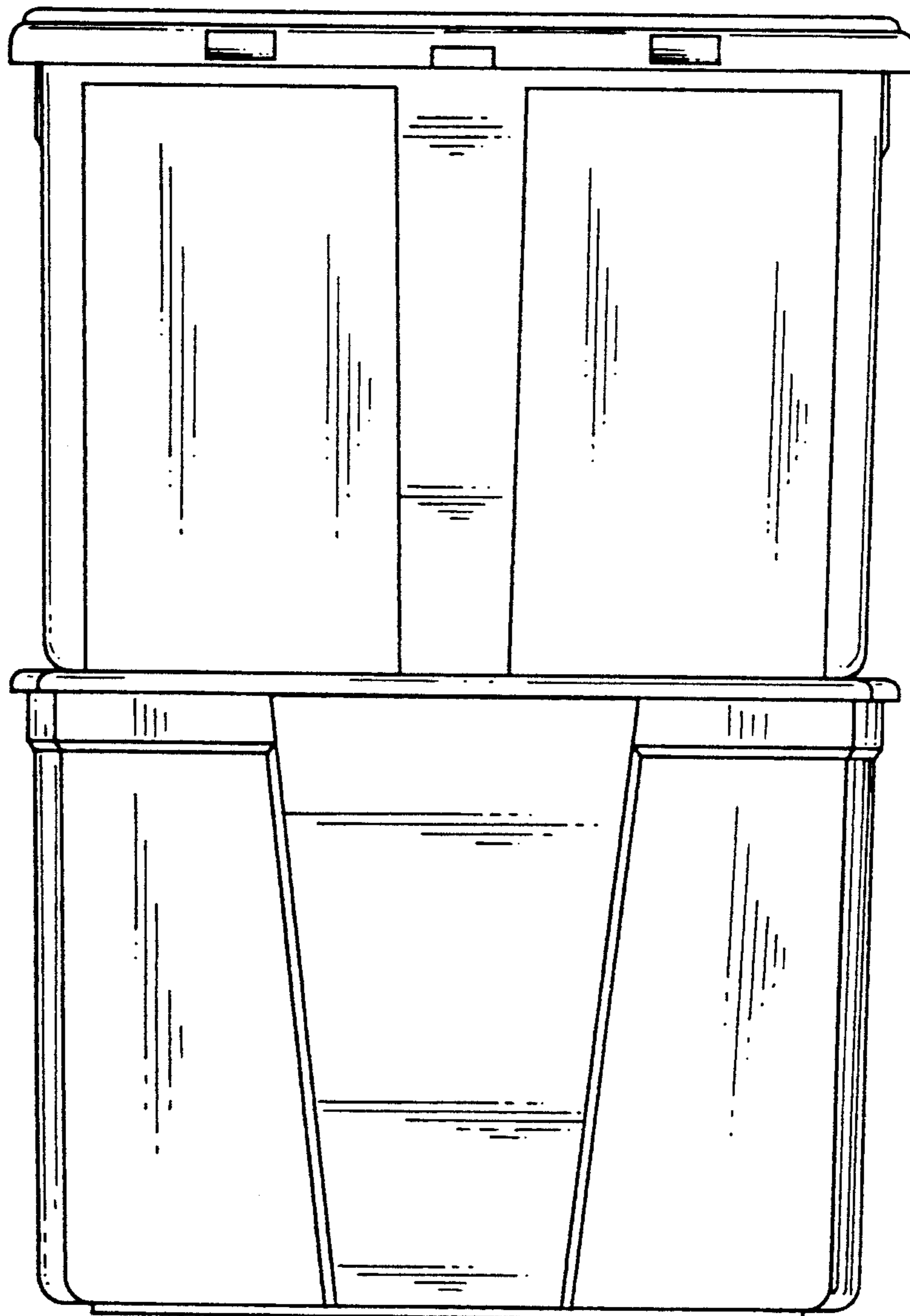
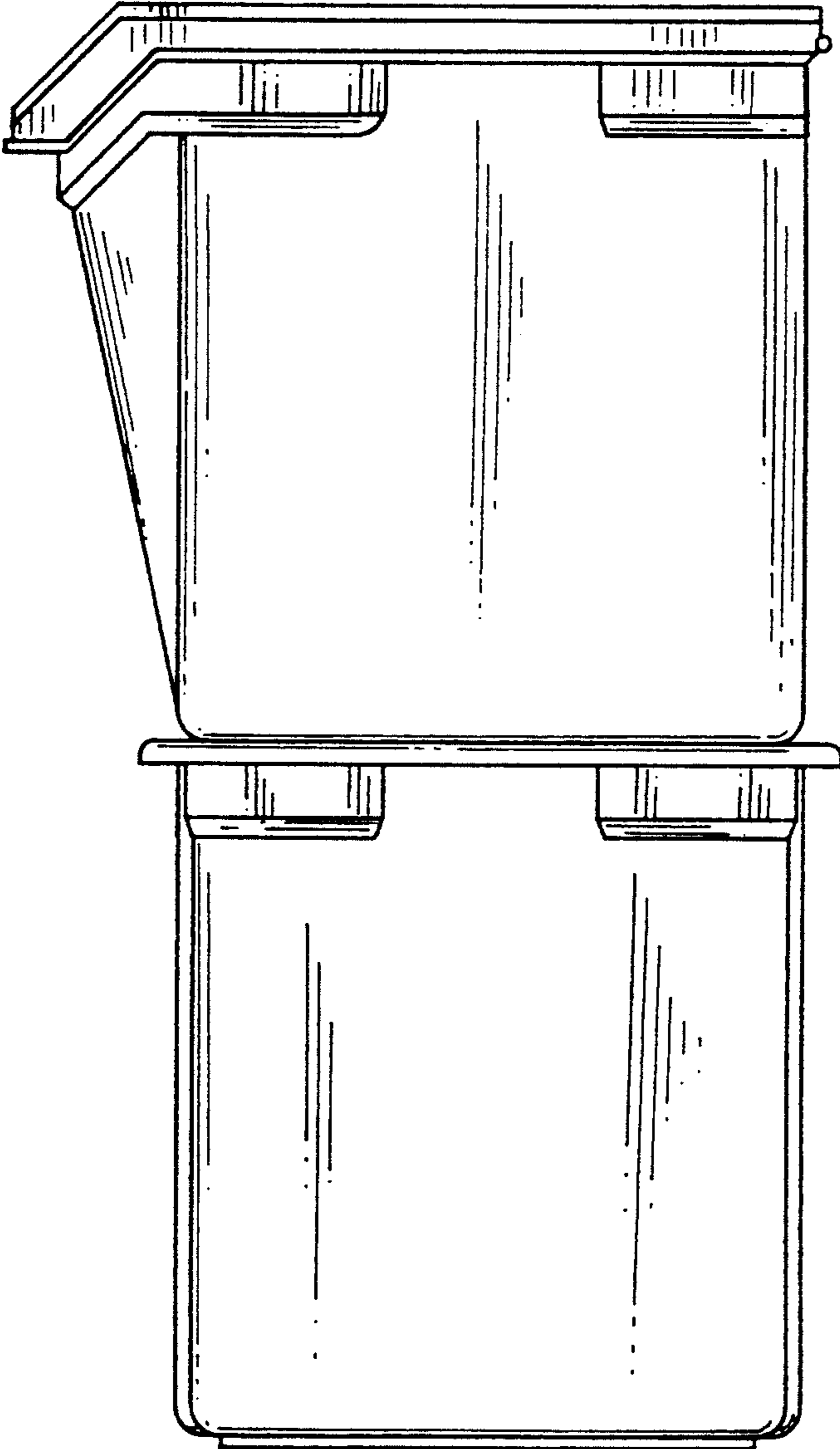

FIG. 4



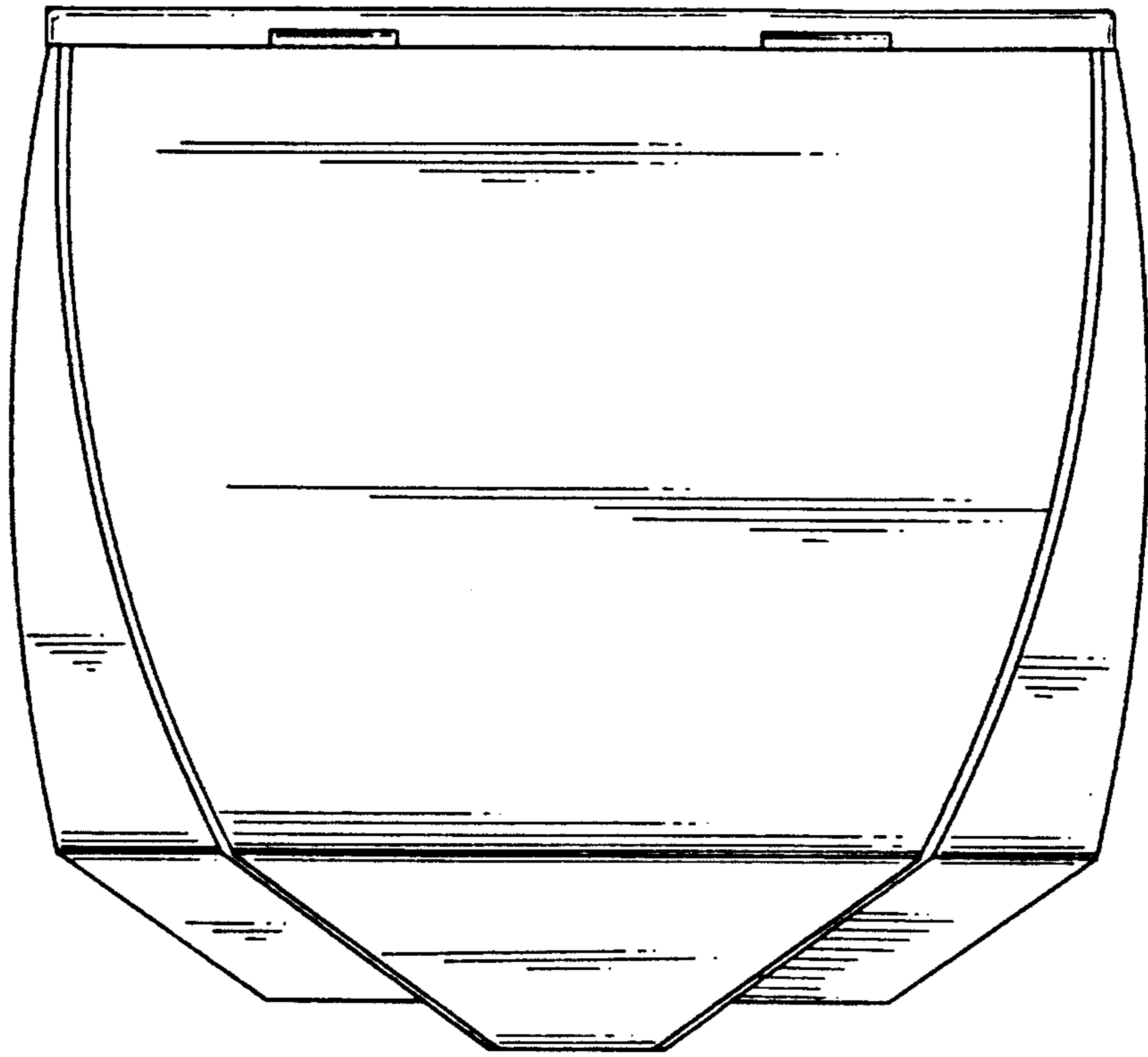

FIG. 5

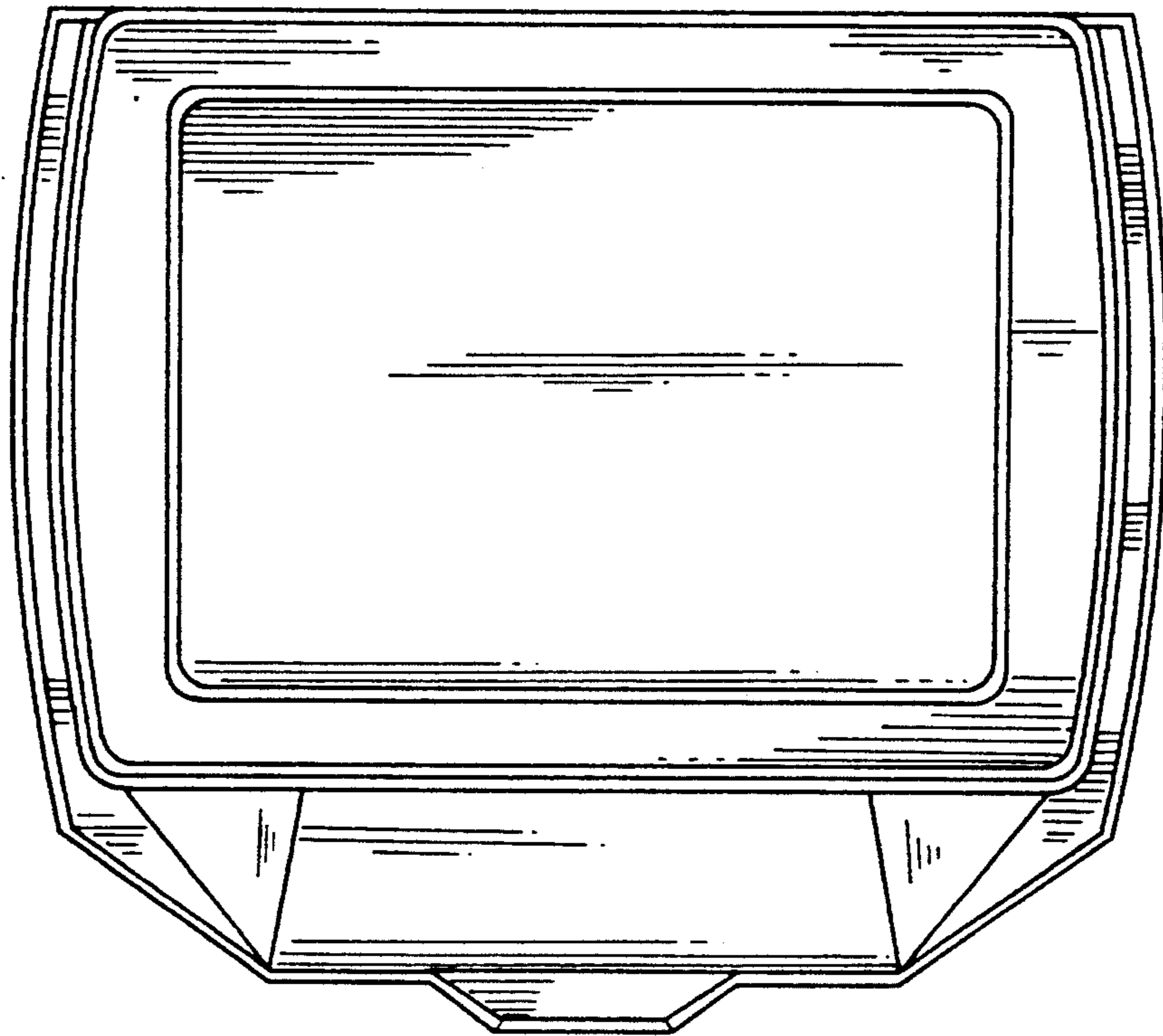

FIG. 6

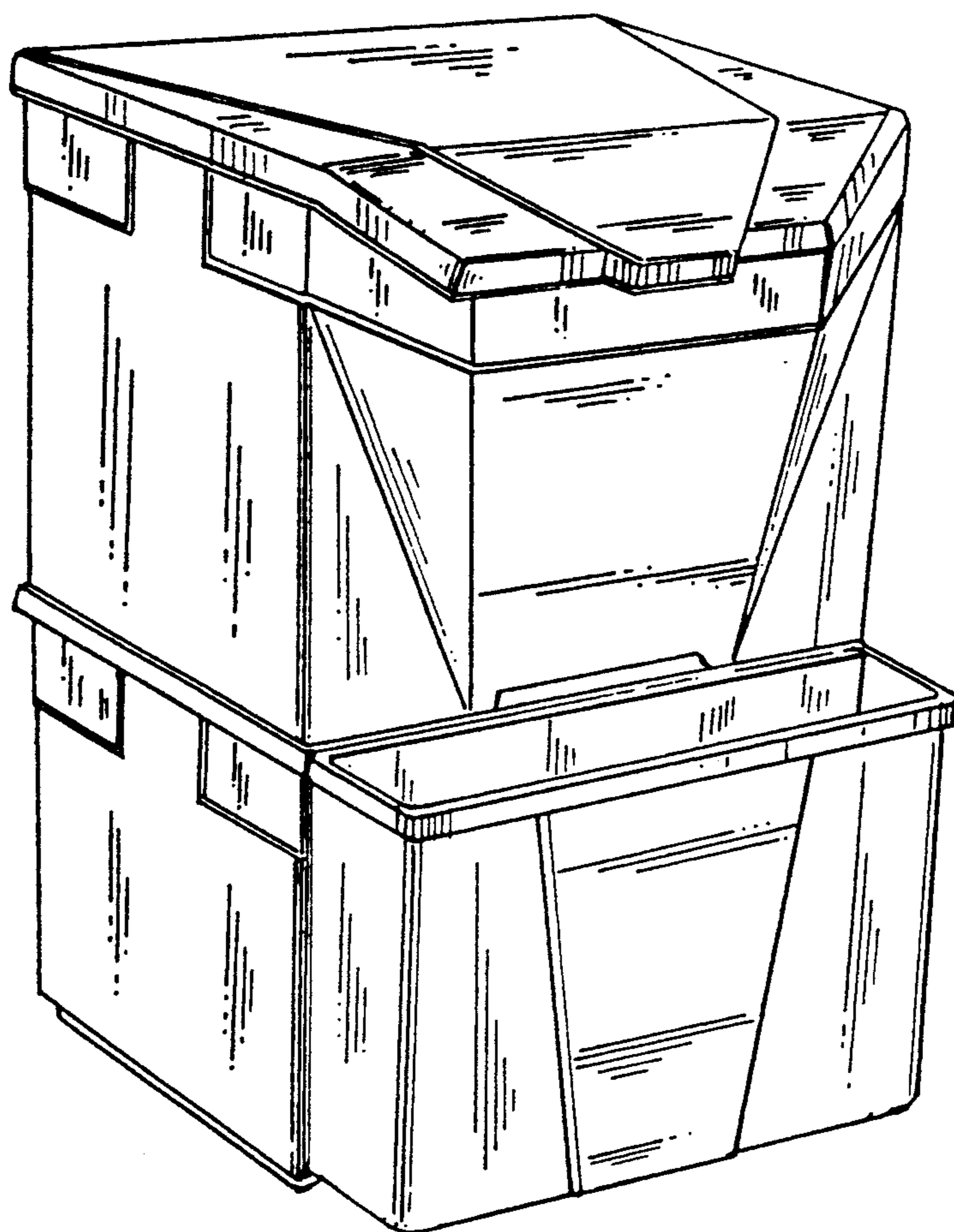

FIG. 7

FIG. 8

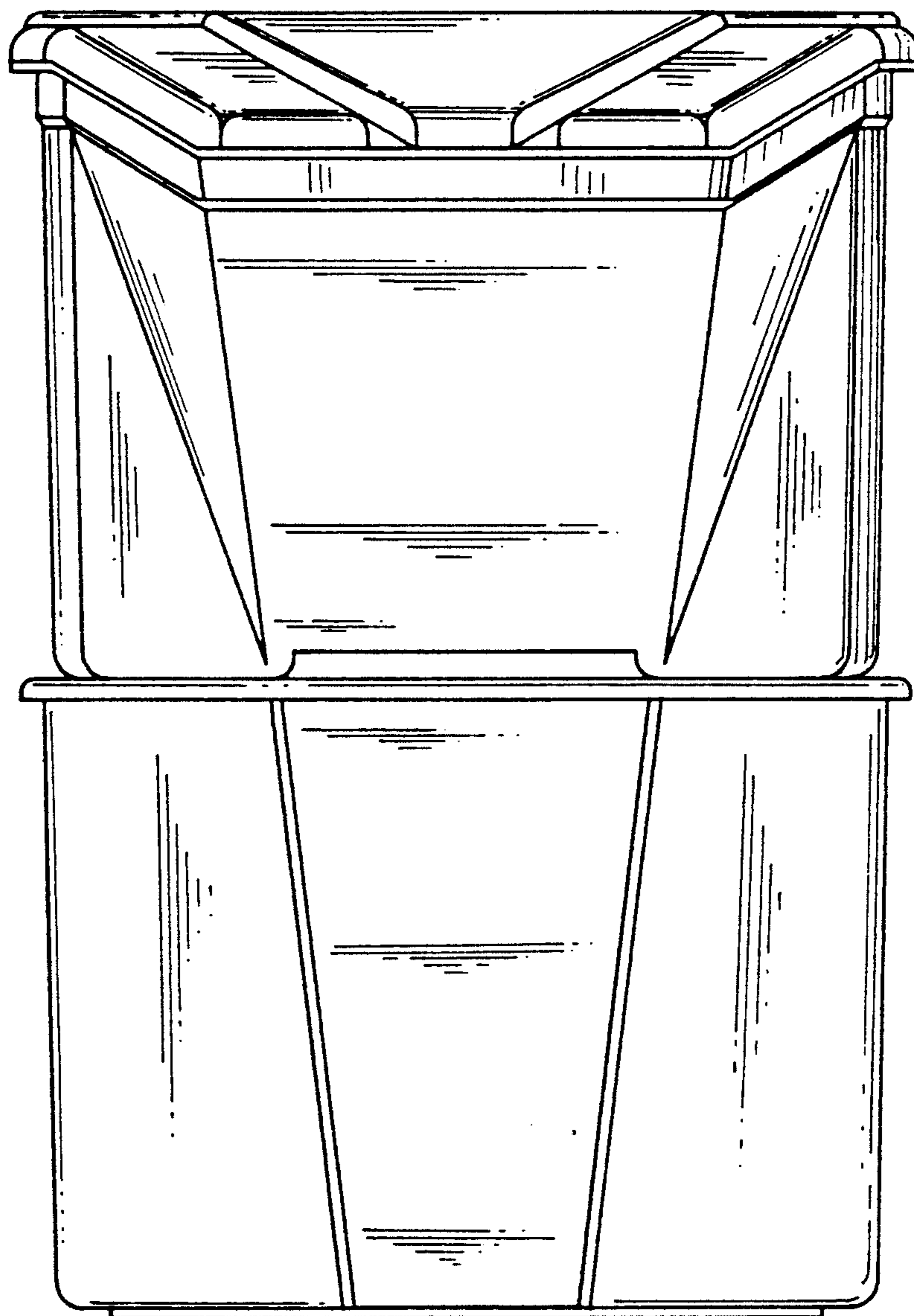

FIG. 9

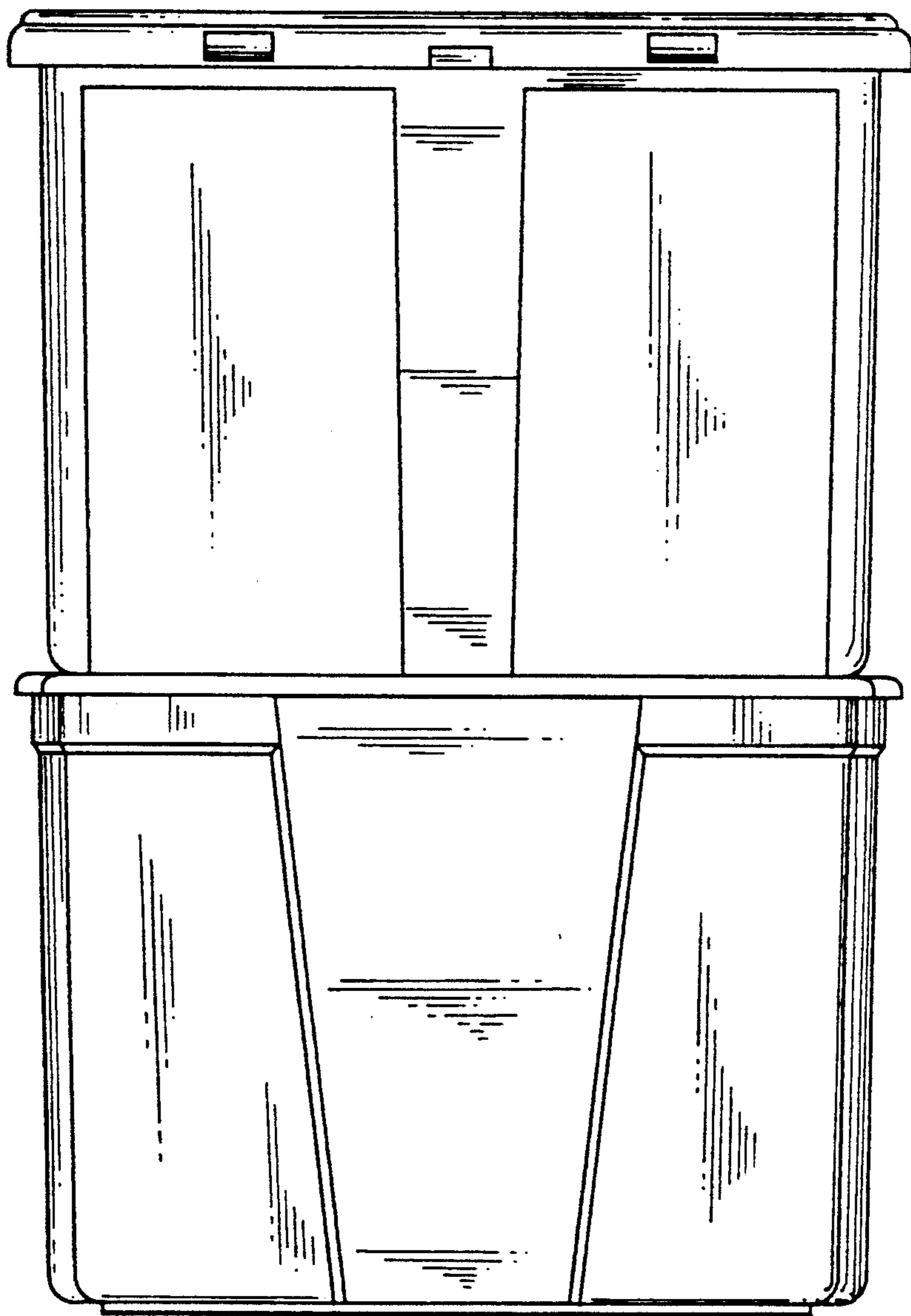
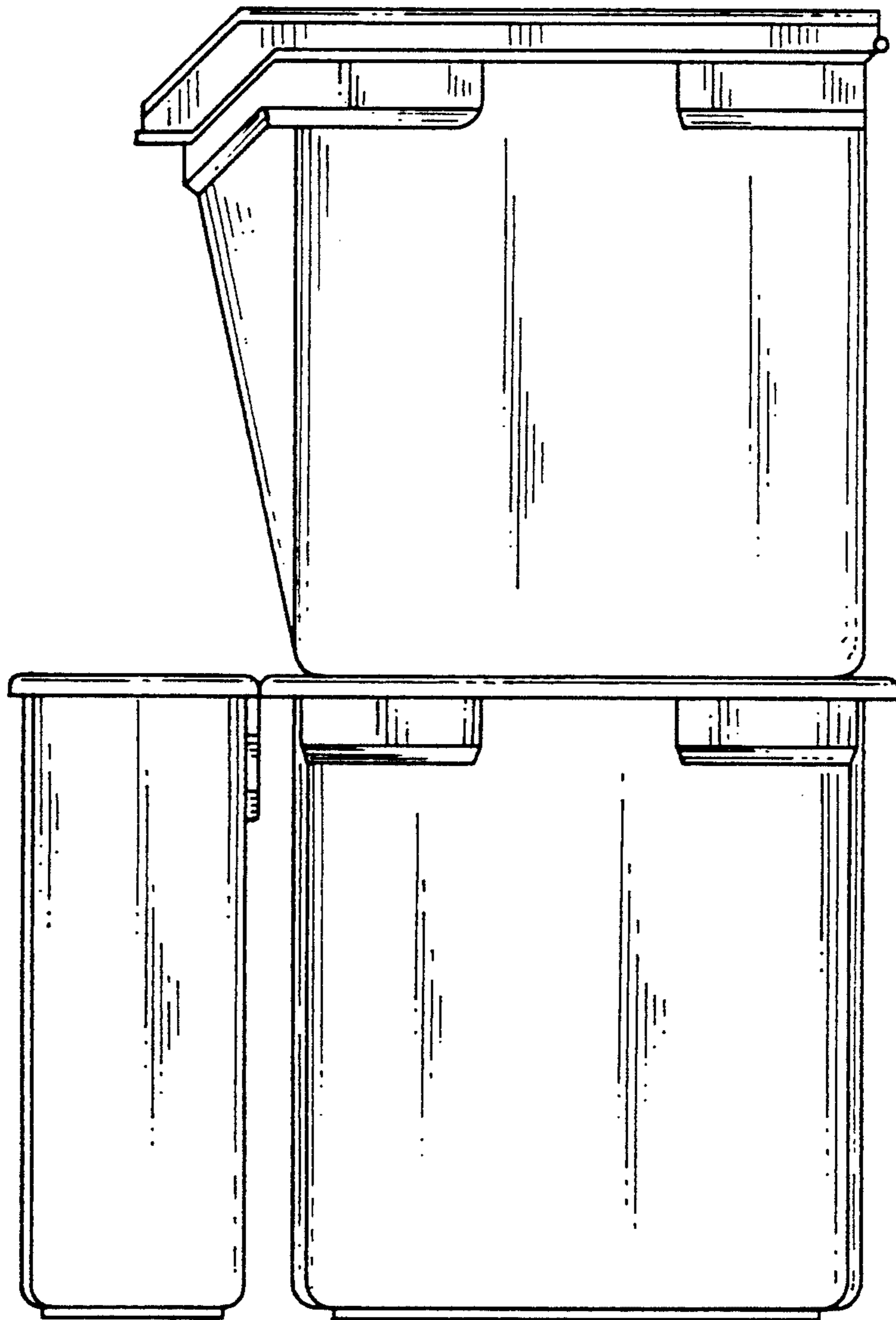

FIG. 10



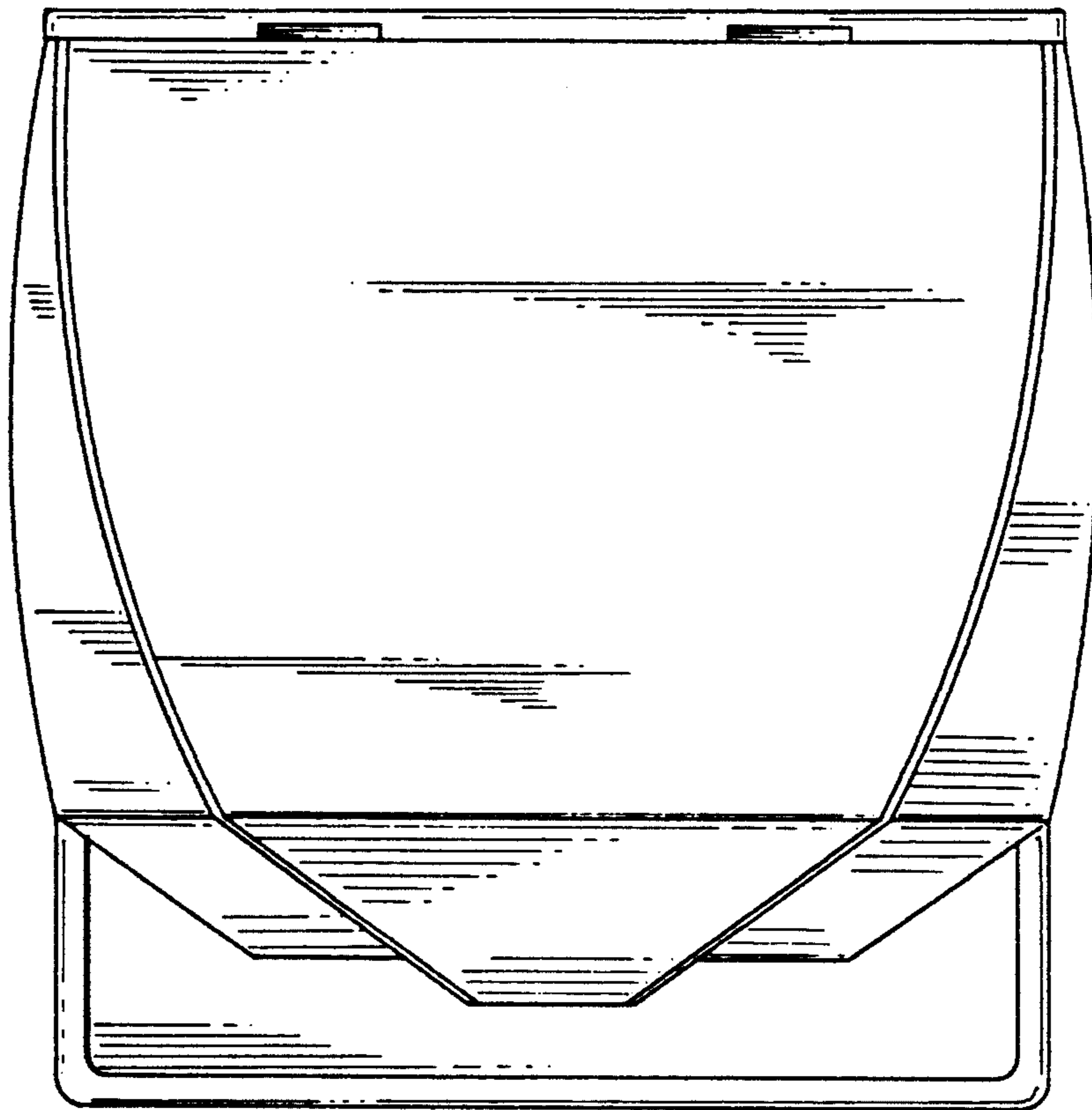

FIG. 11

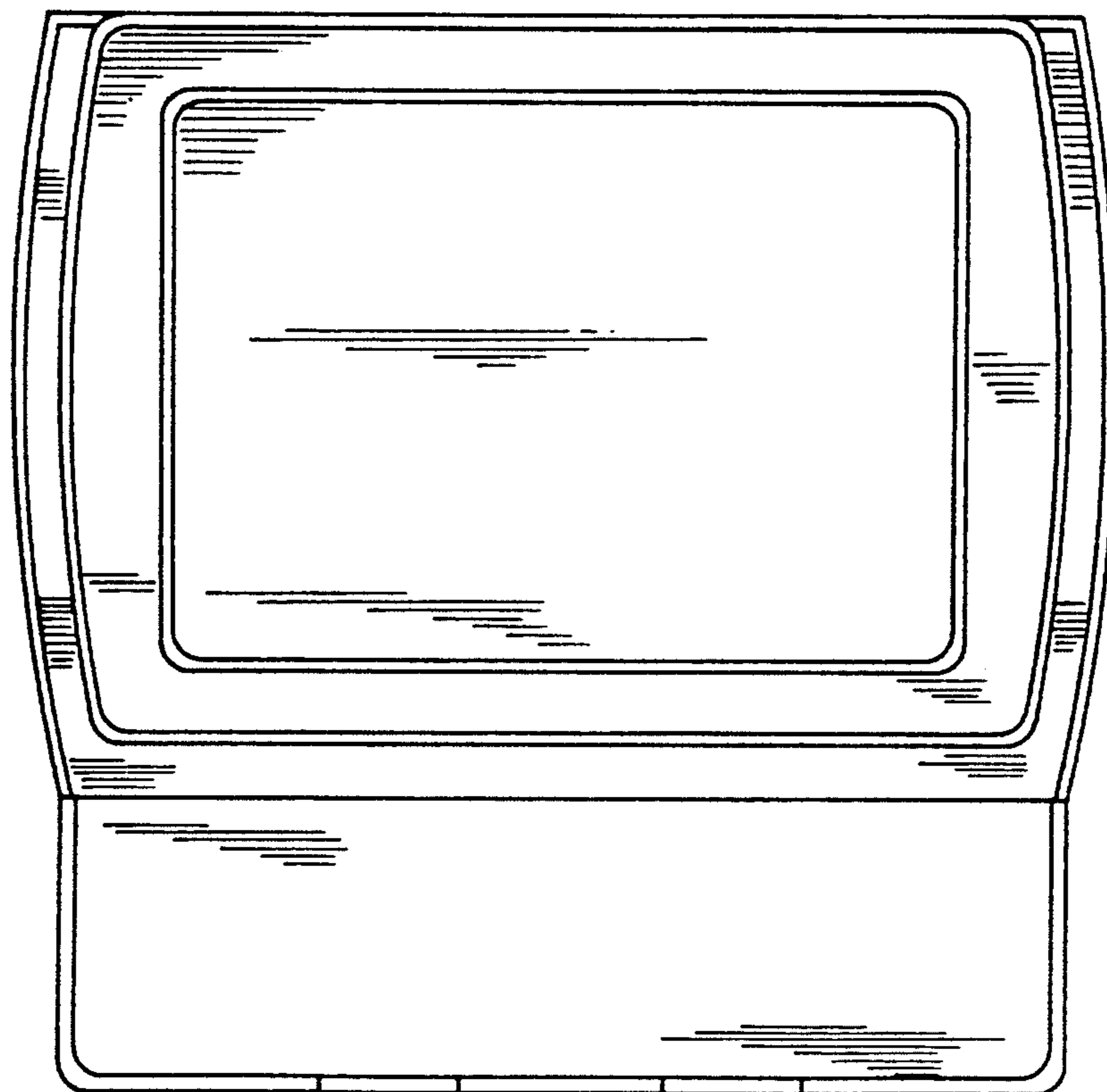

FIG. 12

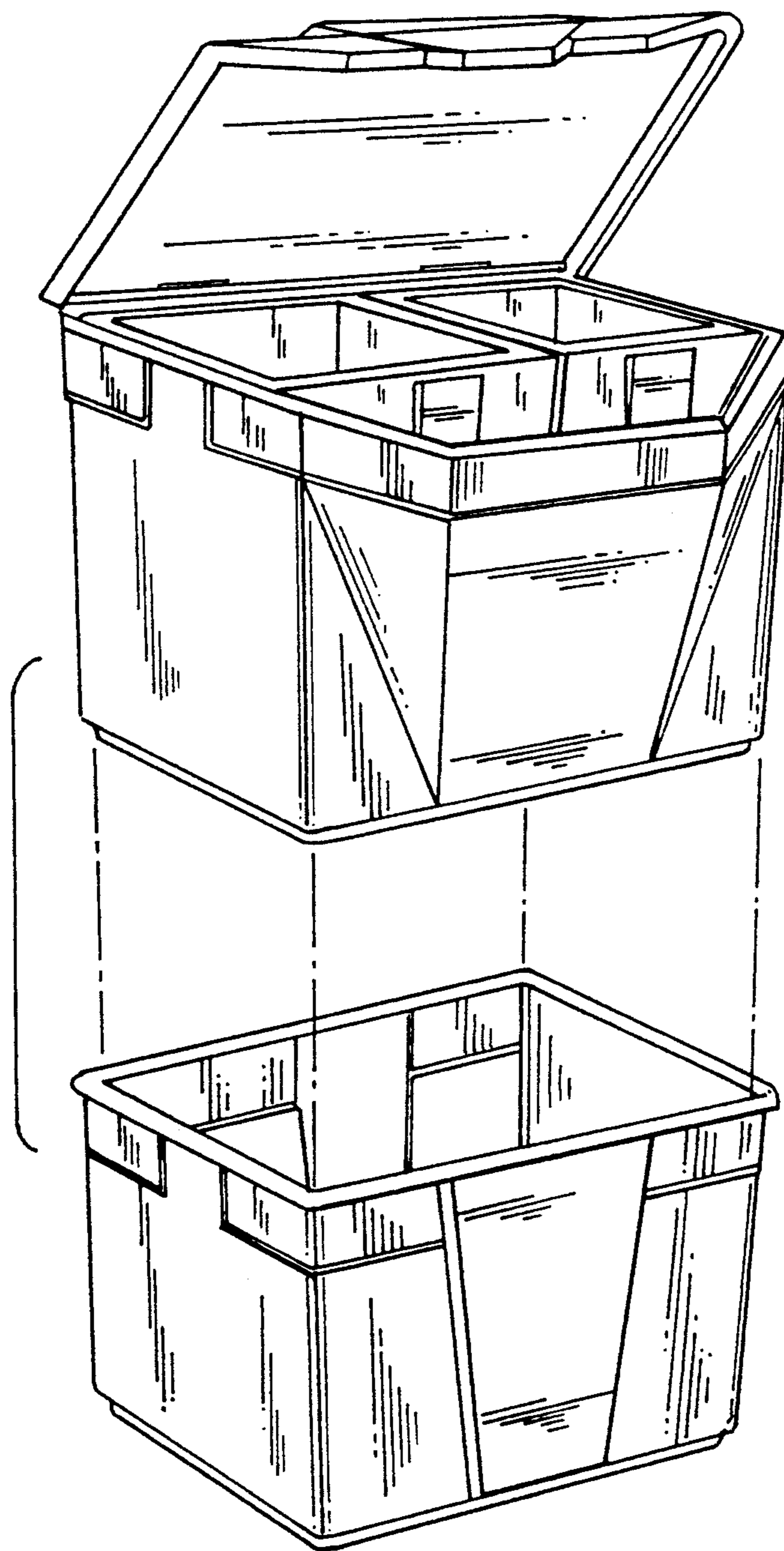

FIG. 13

FIG. 14

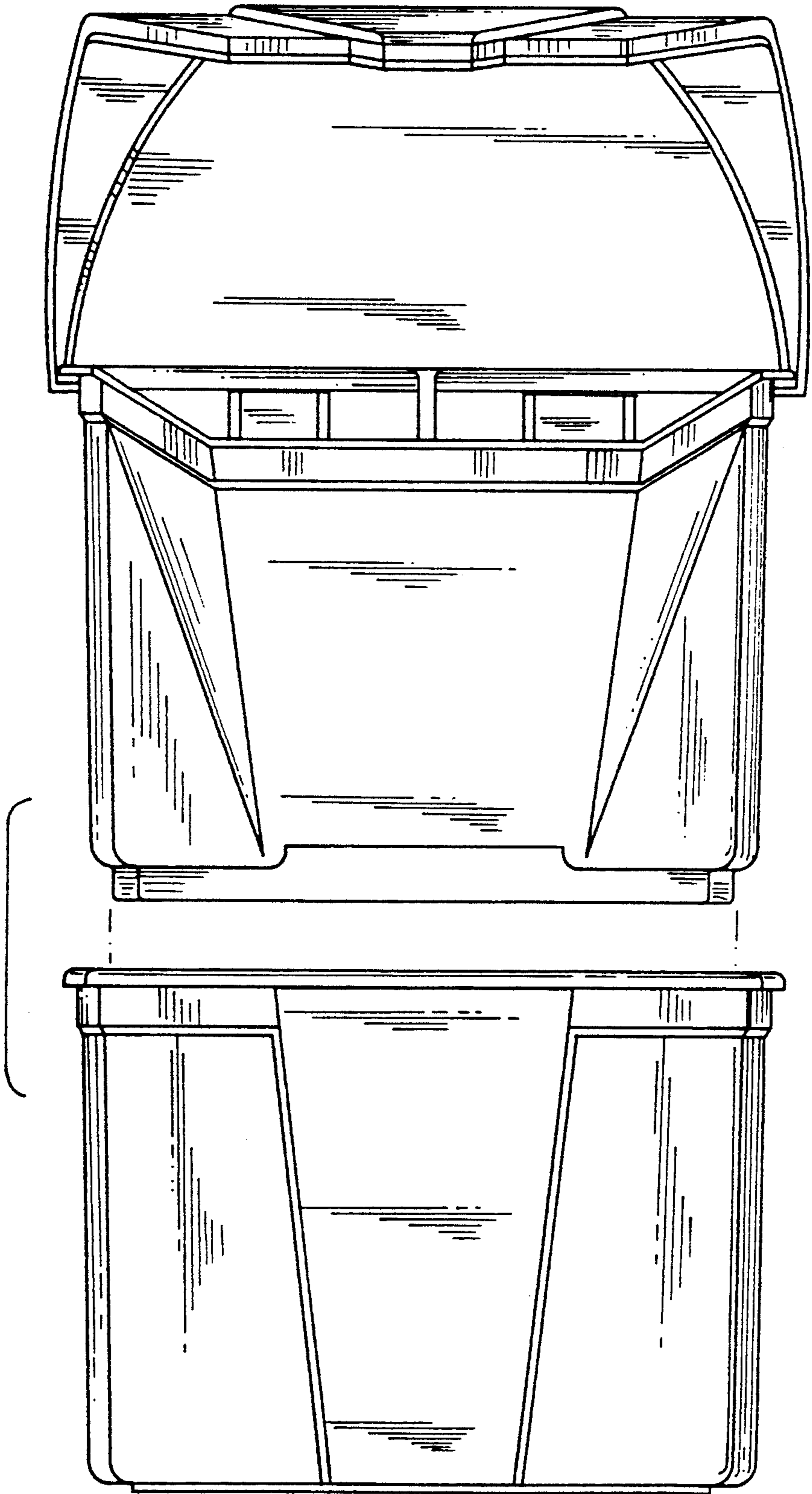

FIG. 15

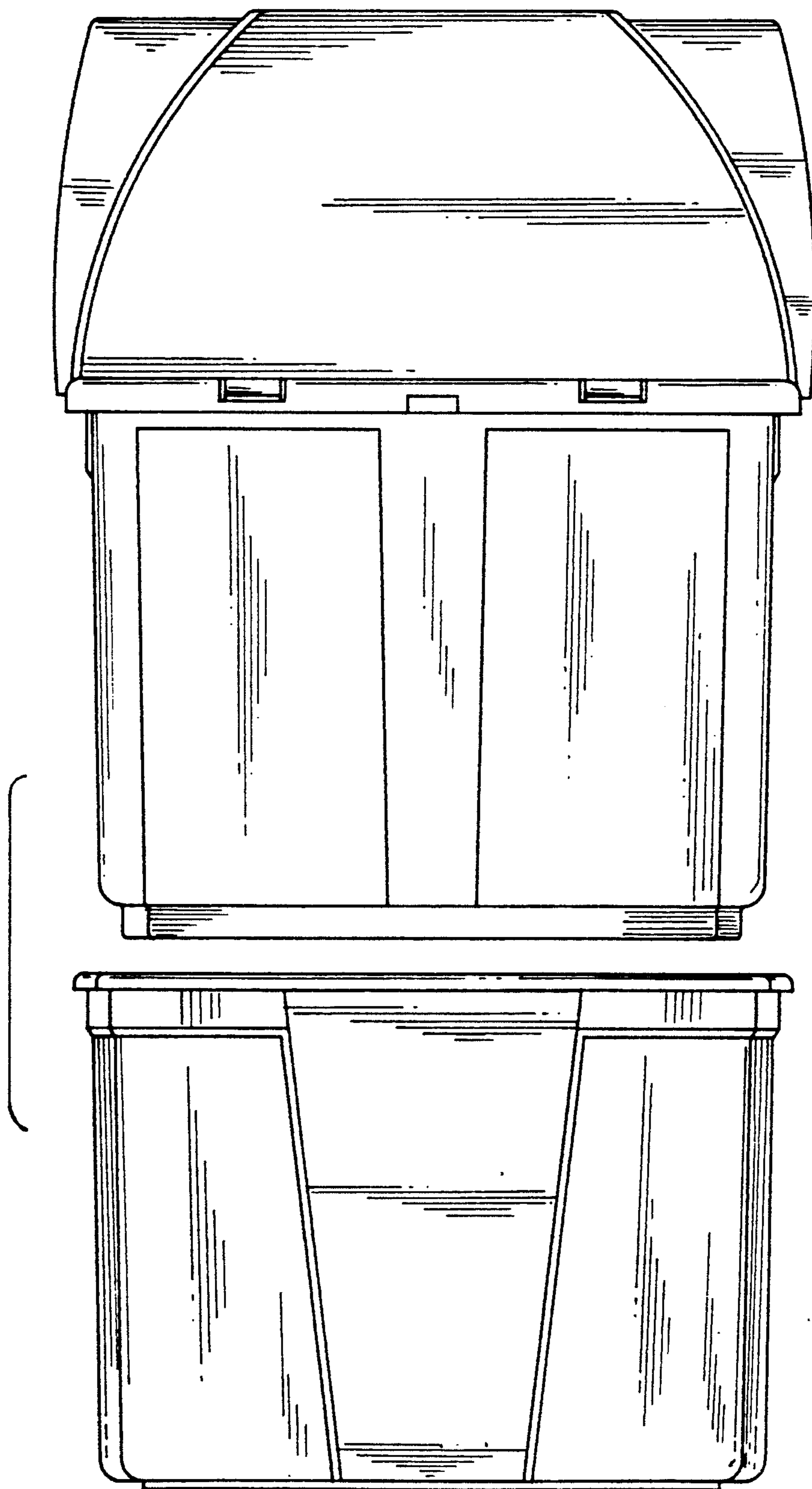
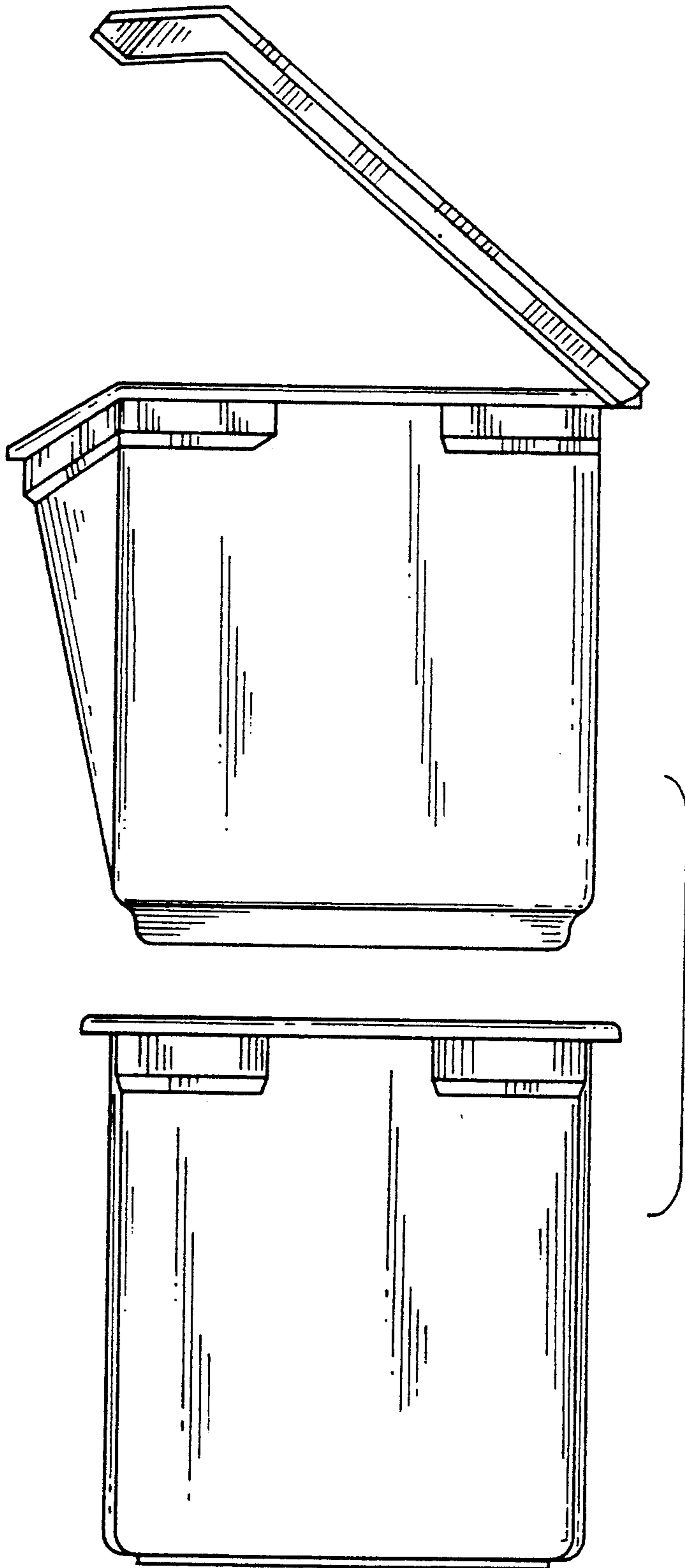

FIG. 16



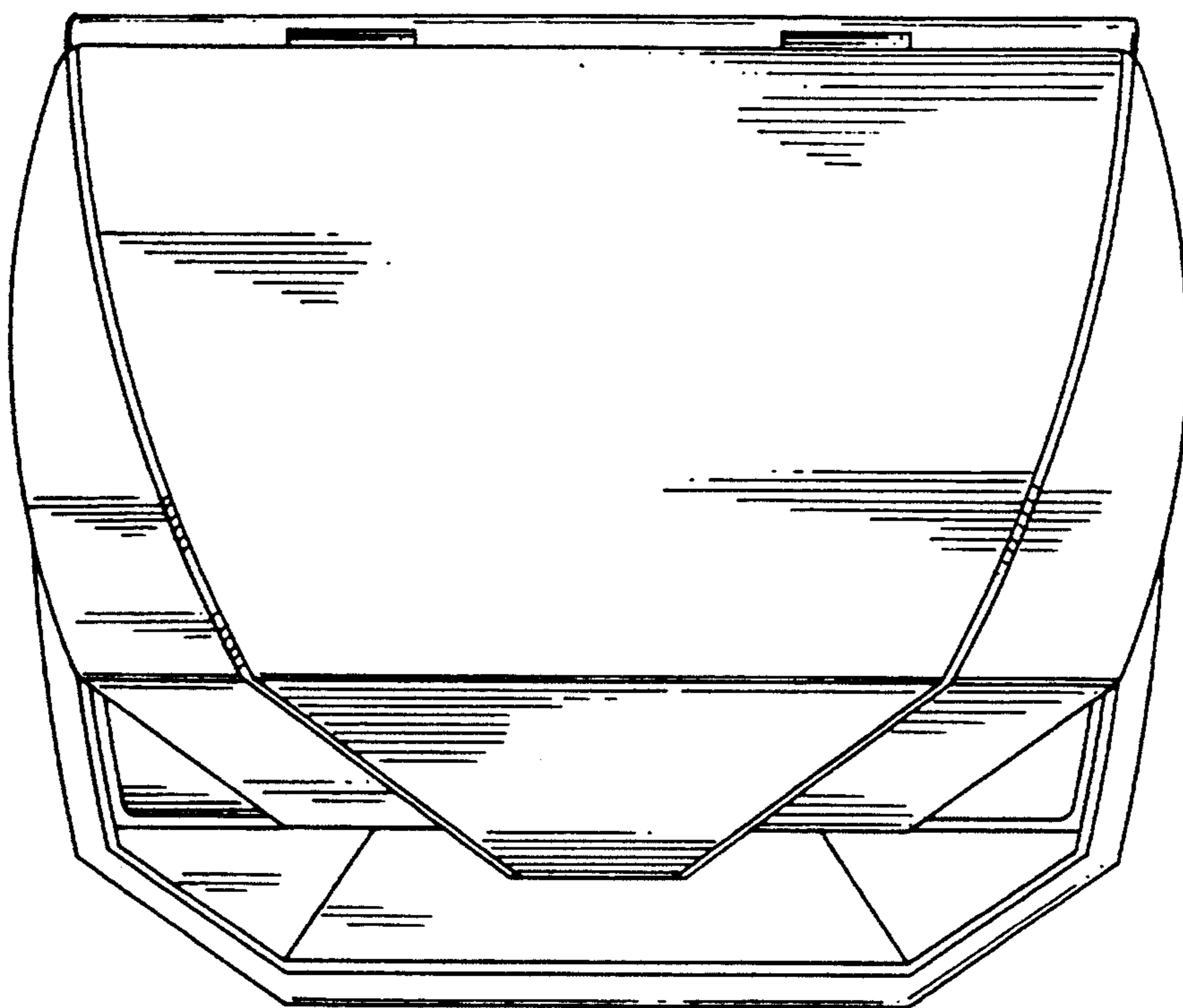

FIG. 17

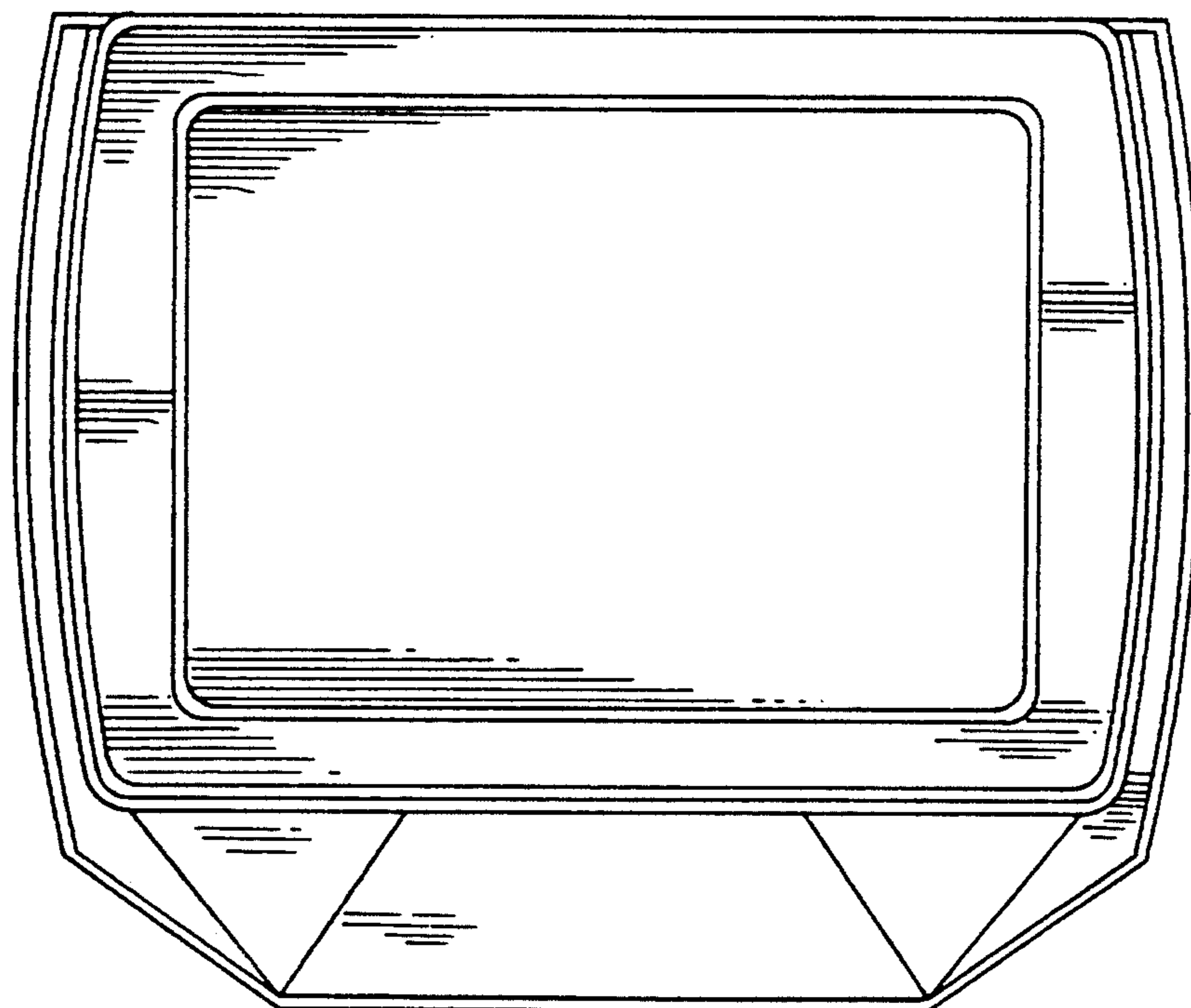

FIG. 18