



US00D348952S

United States Patent [19]
Drucker

[11] **Patent Number: Des. 348,952**
[45] **Date of Patent: ** Jul. 19, 1994**

[54] **TABLE LAMP**

[75] **Inventor: John R. Drucker, Atlanta, Ga.**

[73] **Assignee: Speer Lamp Corp. of New York, Smyrna, Ga.**

[**] **Term: 14 Years**

[21] **Appl. No.: 2,063**

[22] **Filed: Dec. 1, 1992**

[52] **U.S. Cl. D26/110**

[58] **Field of Search 362/410-414;
D26/93, 102-112**

[56] **References Cited**

U.S. PATENT DOCUMENTS

- D. 175,462 8/1955 Clemens D26/110
- D. 318,741 7/1991 Drucker D26/110

OTHER PUBLICATIONS

Baldwin Hardware Corp. Table Lamp Catalog, 1987 Revision, p. EL-10, Table Lamp #7619-030-HBP.

Primary Examiner—Susan J. Lucas
Attorney, Agent, or Firm—Jones & Askew

[57] **CLAIM**

The ornamental design for a table lamp, as shown and described.

DESCRIPTION

FIG. 1 is a front perspective view of a table lamp showing my new design;
 FIG. 2 is a front elevation view thereof;
 FIG. 3 is a right side elevation view thereof;
 FIG. 4 is a left side elevation view thereof;
 FIG. 5 is a rear elevation view thereof;
 FIG. 6 is a top plan view thereof; and,
 FIG. 7 is a bottom plan view thereof.
 The broken-line showing of a lamp shade is for illustrative purposes only and forms no part of the claimed design.

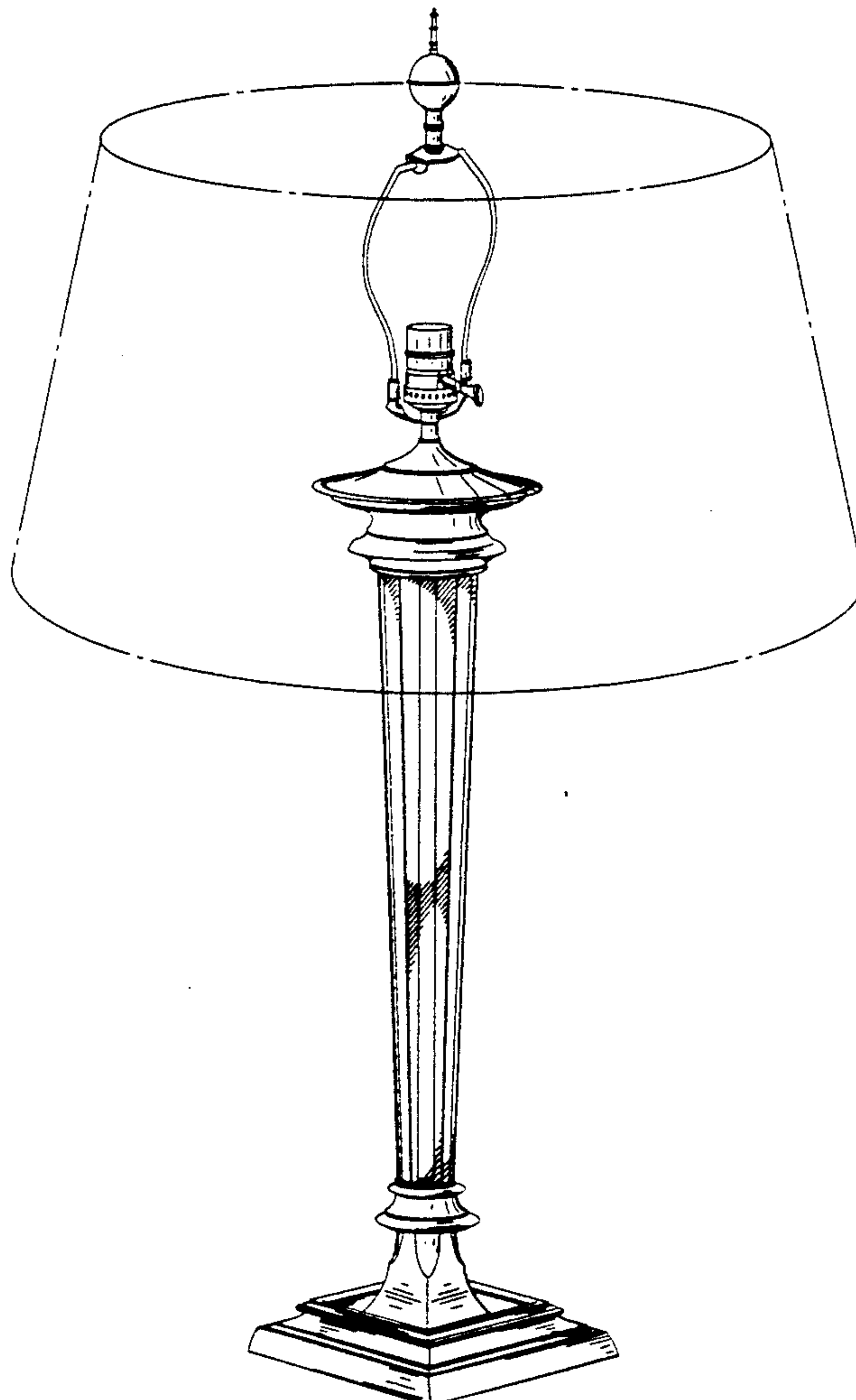

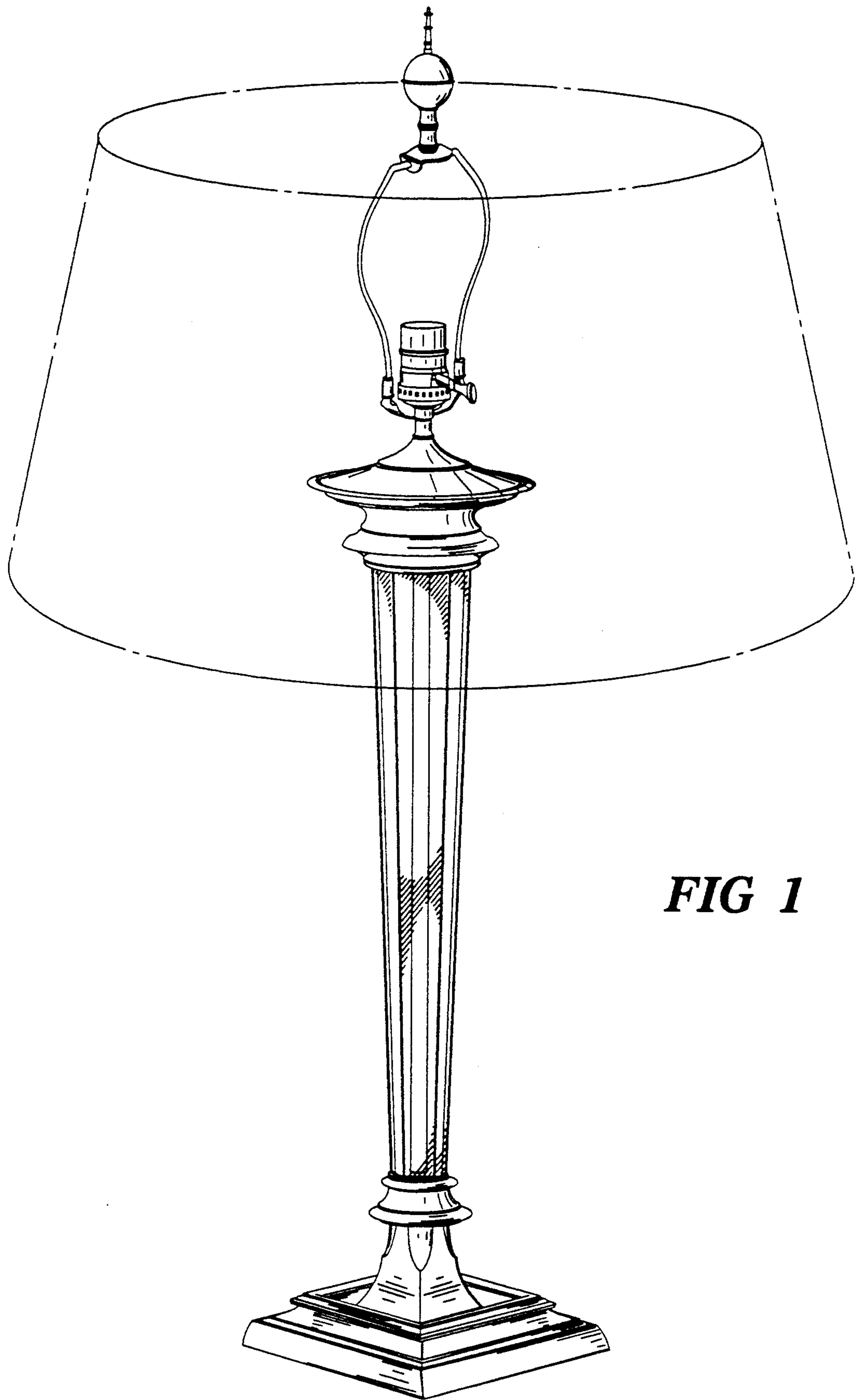

FIG 1

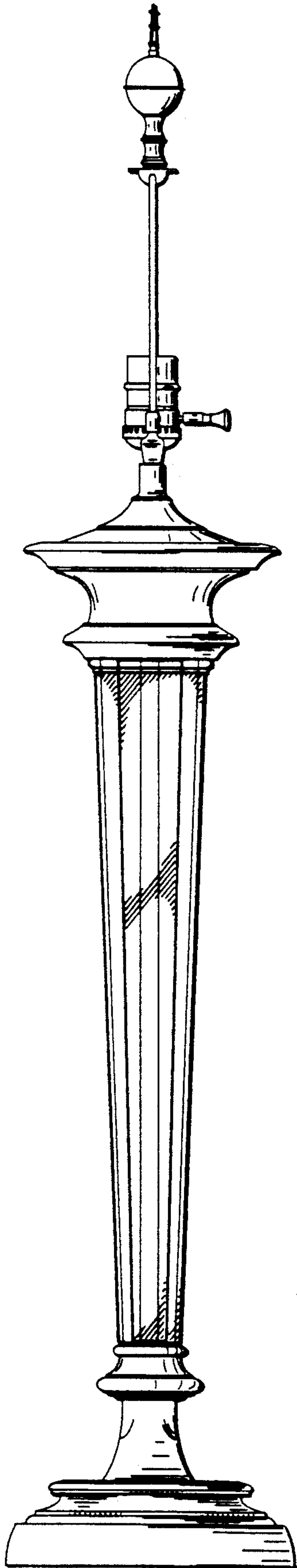

FIG 2

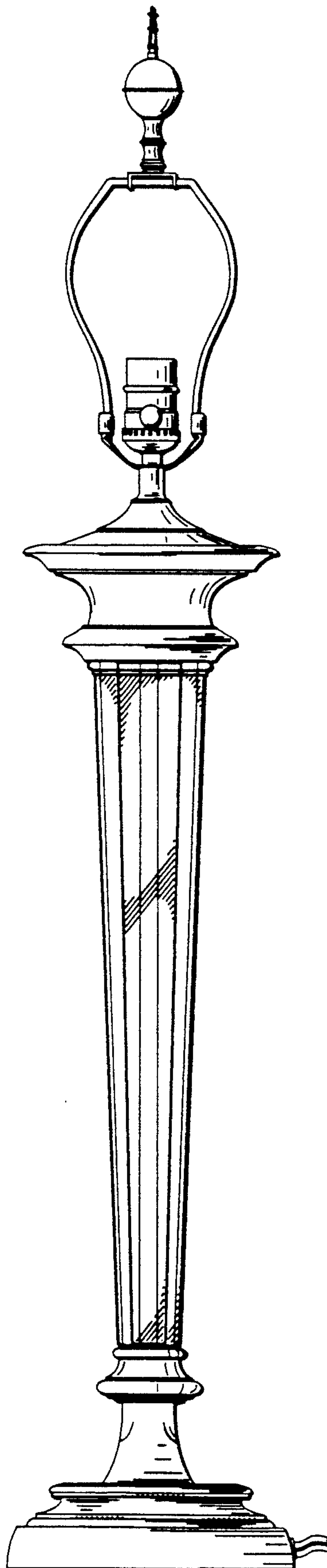

FIG 3

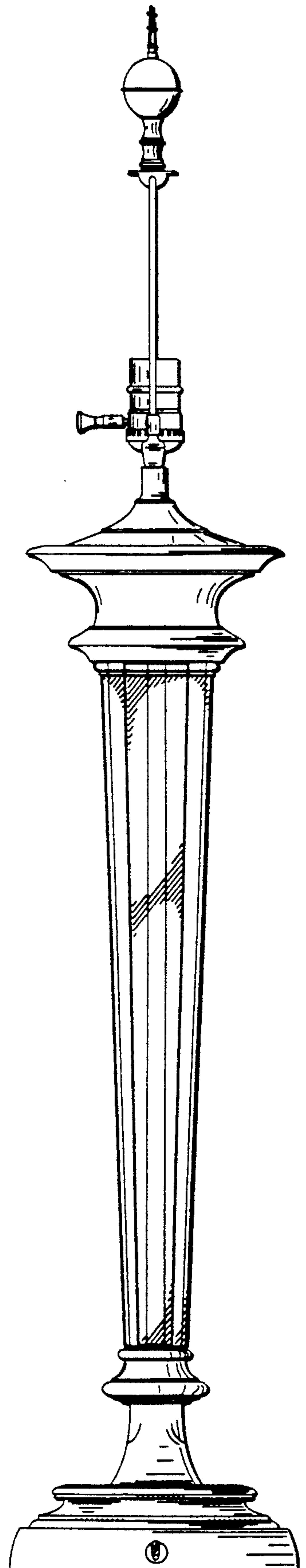

FIG 4

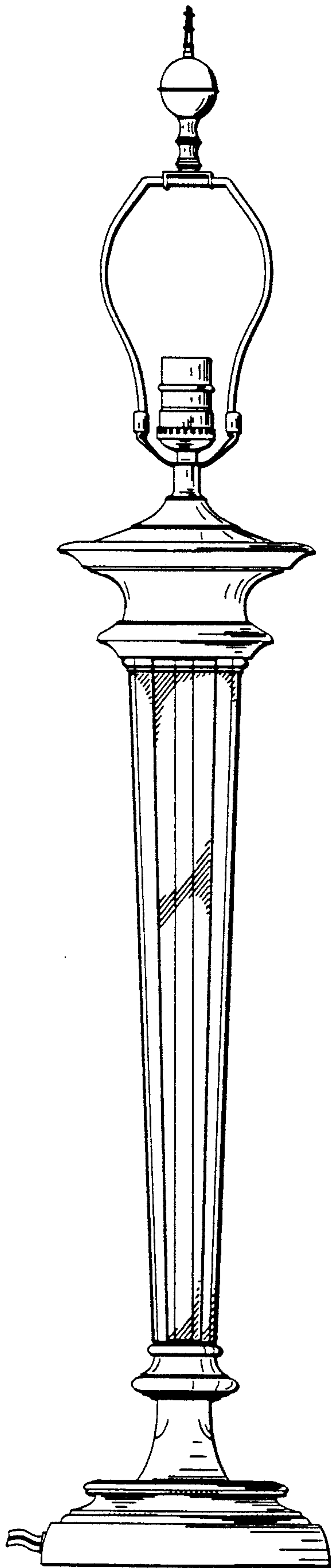

FIG 5

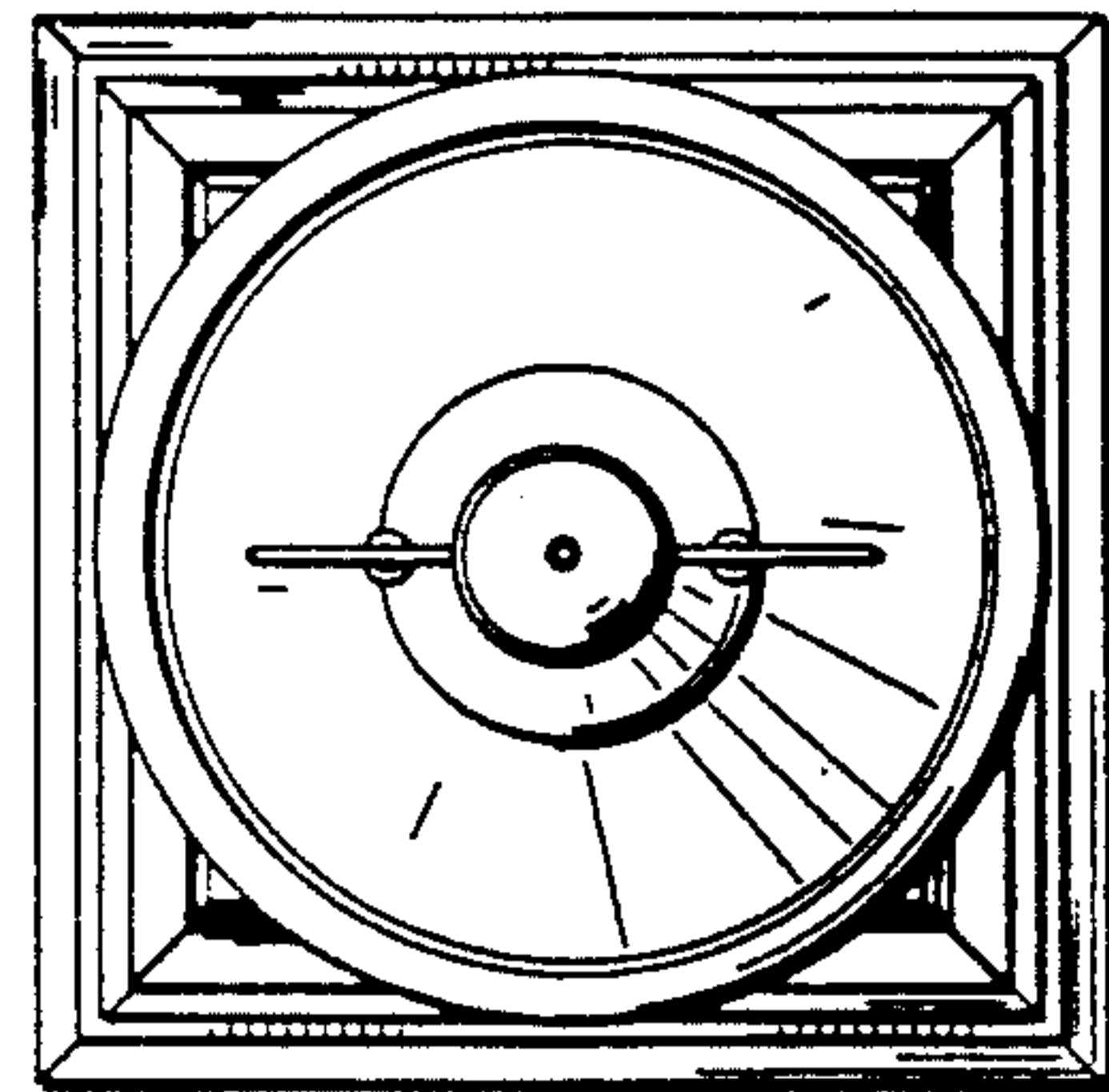

FIG 6

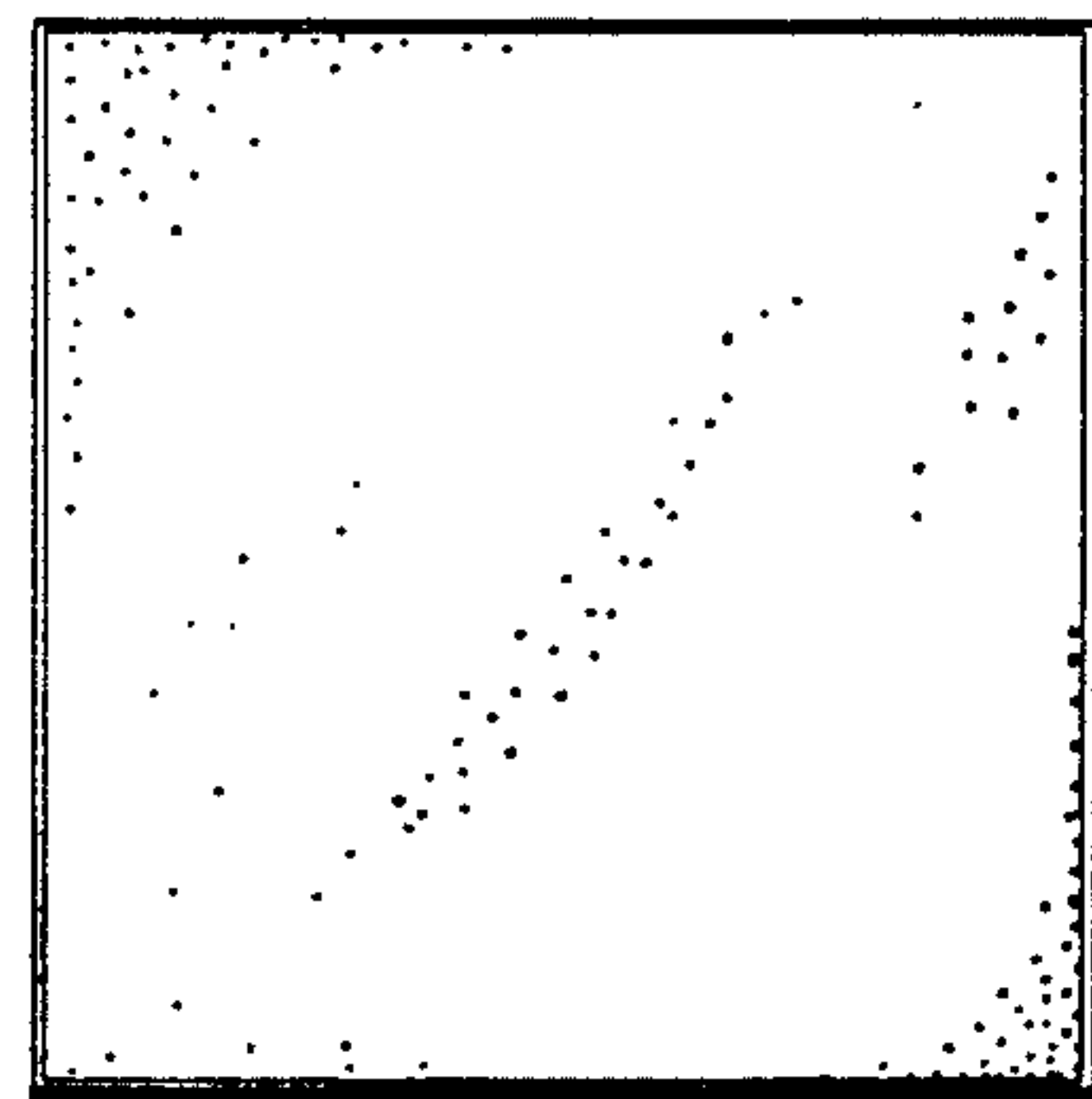

FIG 7