



US00D348902S

United States Patent [19]

[11] Patent Number: **Des. 348,902**

Beyer

[45] Date of Patent: **** Jul. 19, 1994**

[54] **CLIP**

D. 331,722 12/1992 Kunststadt D10/122
5,079,808 1/1992 Brown 24/67.7

[75] Inventor: **John P. Beyer**, 2481 Kenney, NW.,
Grand Rapids, Mich. 49504

OTHER PUBLICATIONS

[73] Assignee: **John P. Beyer**, Grand Rapids, Mich.

F. O. Merz & Co, 1966, p. 1, see Ladybug Clip upper right.

[**] Term: **14 Years**

J. C. Whitney & Co. ©1982, p. 96, see circled accelerator pedal.

[21] Appl. No.: **954,928**

Primary Examiner—Nelson C. Holtje
Assistant Examiner—Martie Thompson
Attorney, Agent, or Firm—Price, Heneveld, Cooper,
DeWitt & Litton

[22] Filed: **Sep. 30, 1992**

[52] U.S. Cl. **D19/65; D8/395;**
D19/86

[58] **Field of Search** D8/394, 395; 24/500,
24/499, 501, 507, 508, 511, 67.7, 67.8, 67.9, 555,
546-549, 563, 10 R, 67 R; D10/8, 122; D19/65,
86, 88, 99, 100

[57] CLAIM

The ornamental design for a clip, as shown and described.

[56] References Cited

DESCRIPTION

U.S. PATENT DOCUMENTS

| | | | | |
|------------|---------|---------|-------|----------|
| D. 90,930 | 10/1933 | Todd | | D8/395 X |
| D. 286,013 | 10/1986 | Adams | | D8/395 |
| D. 298,703 | 11/1988 | Arnold | | D8/395 X |
| D. 299,006 | 12/1988 | Mednick | | D8/395 X |
| D. 302,568 | 8/1989 | Berger | | D8/395 X |
| D. 316,333 | 4/1991 | Maki | | D8/395 X |
| D. 328,242 | 7/1992 | Chan | | D8/395 X |

FIG. 1 is a top, front perspective view of a clip showing my new design;
FIG. 2 is a front elevational view thereof;
FIG. 3 is a rear elevational view thereof;
FIG. 4 is a top plan view thereof;
FIG. 5 is a bottom plan view thereof;
FIG. 6 is a right side elevational view; and,
FIG. 7 is a left side elevational view thereof.

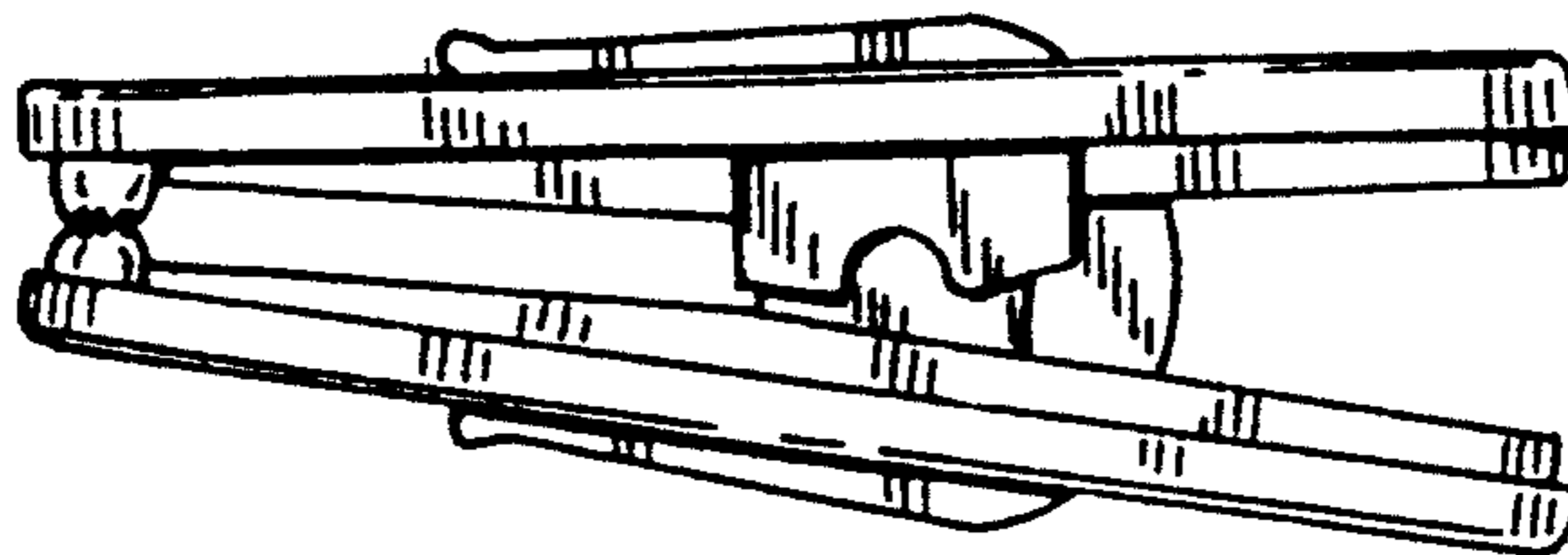
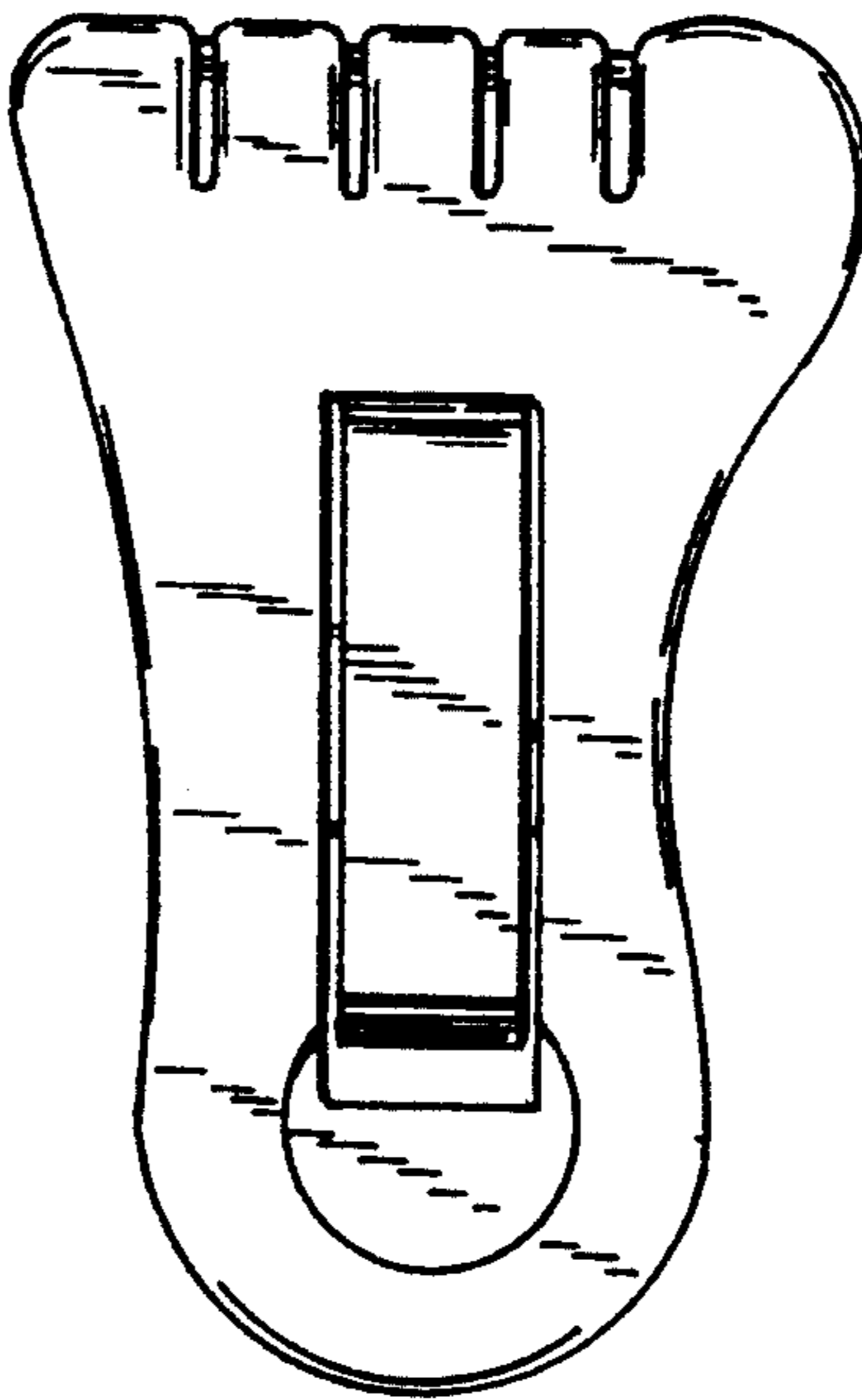

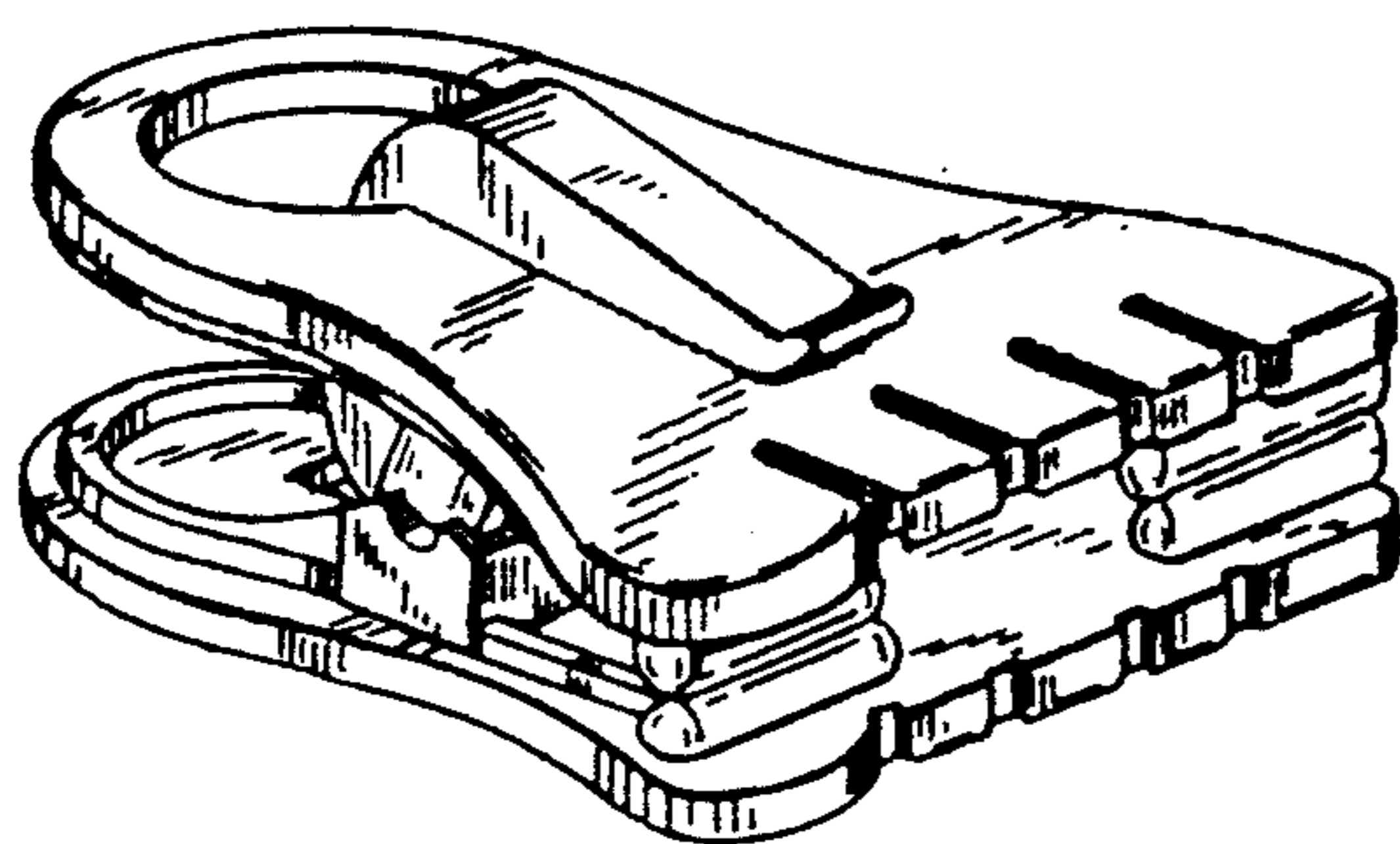

FIG. 1

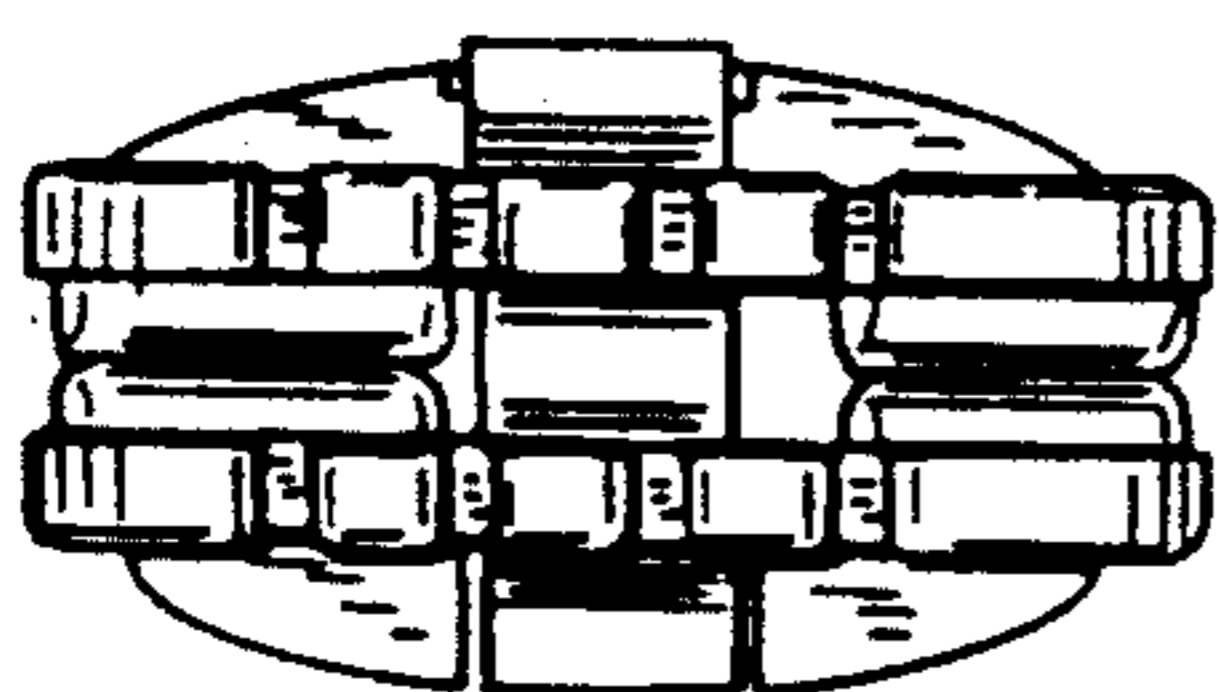

FIG. 2

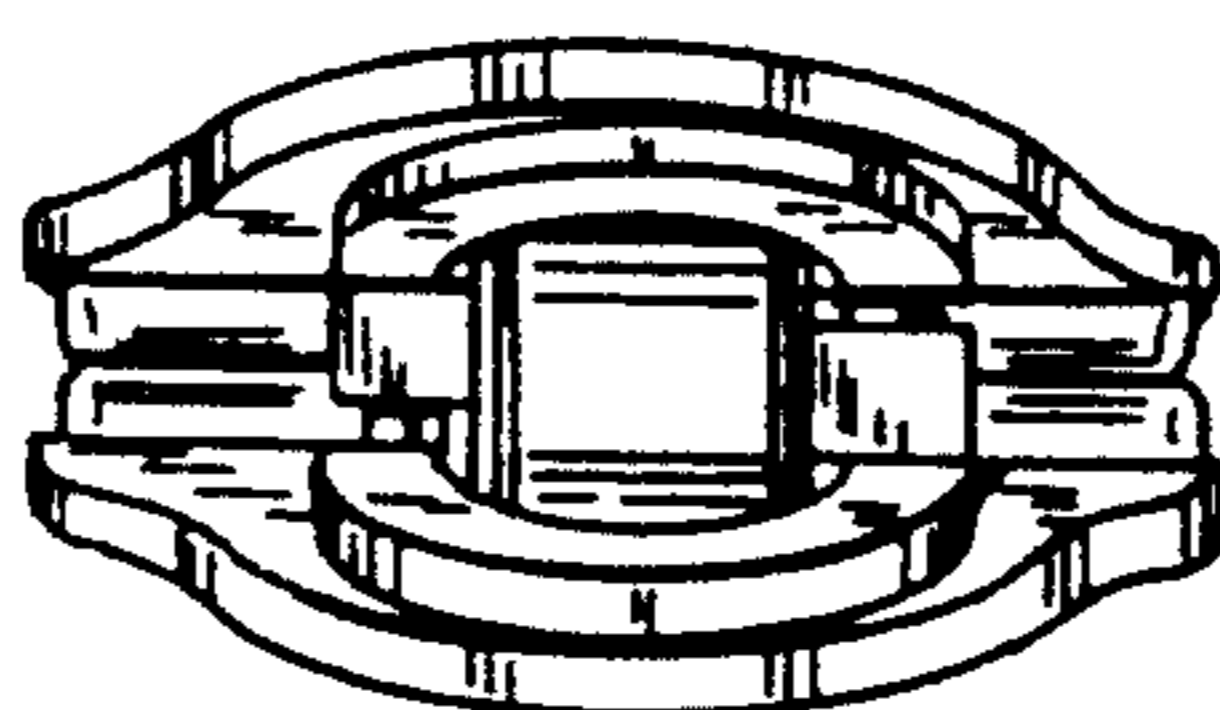

FIG. 3

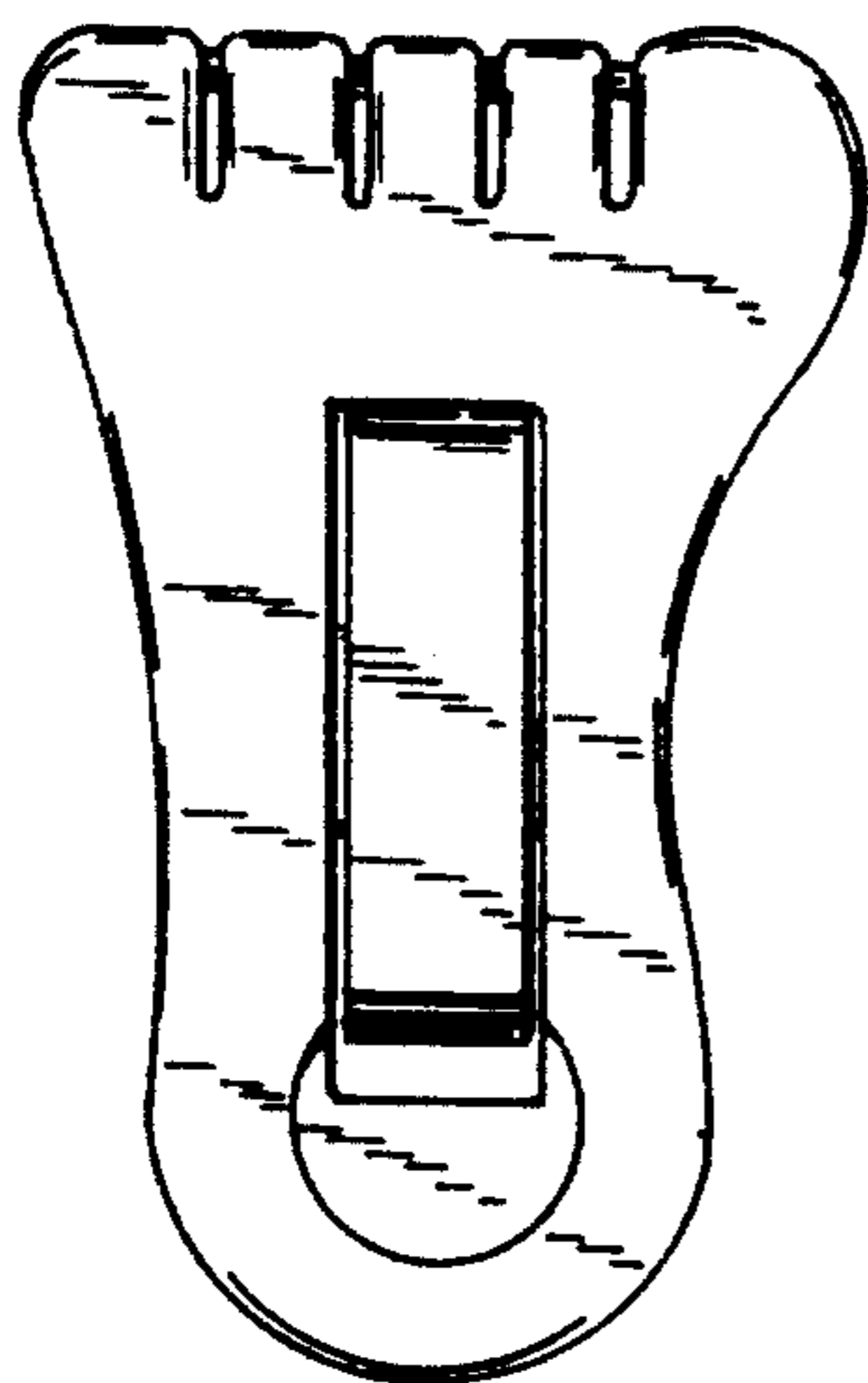

FIG. 4

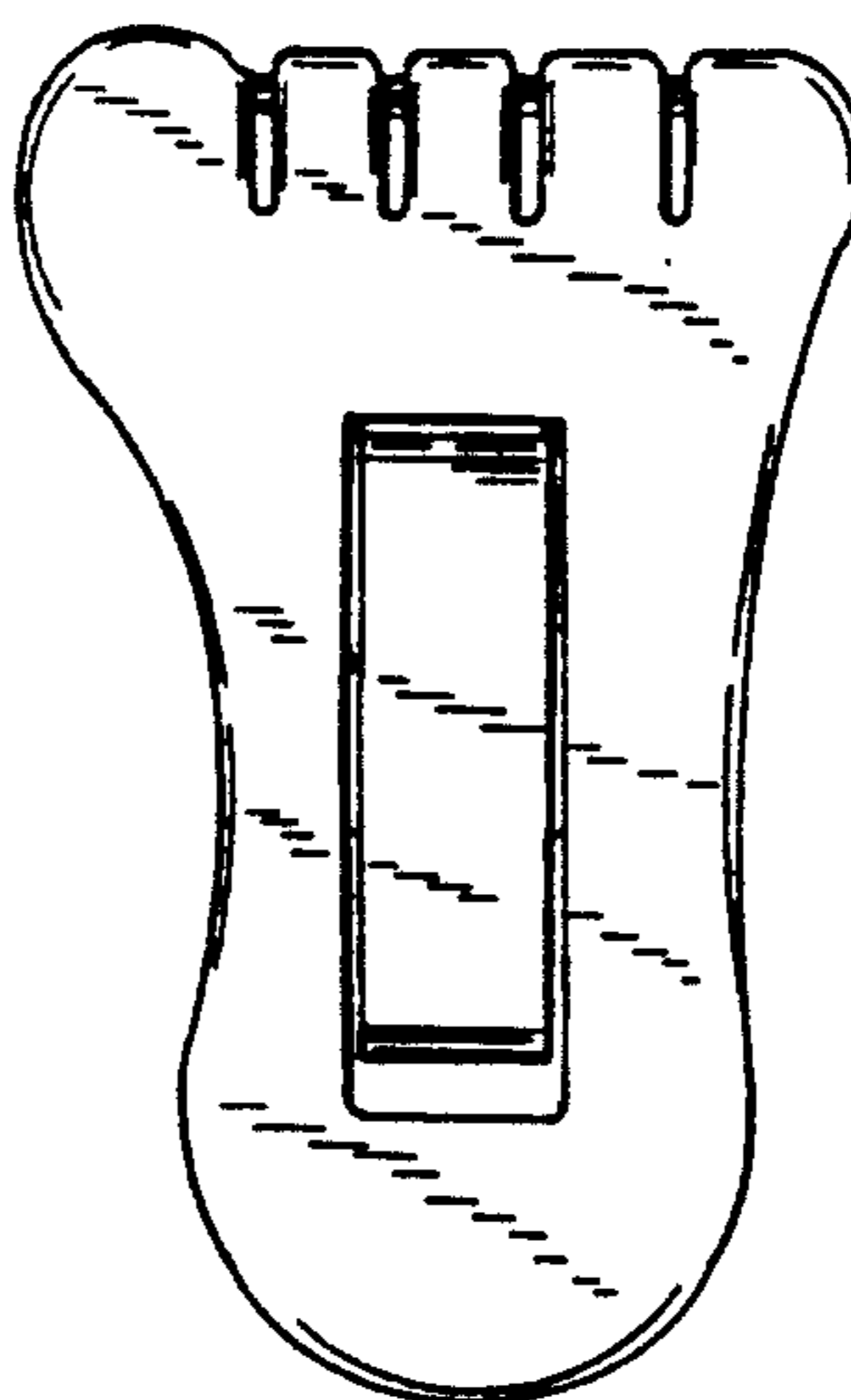

FIG. 5

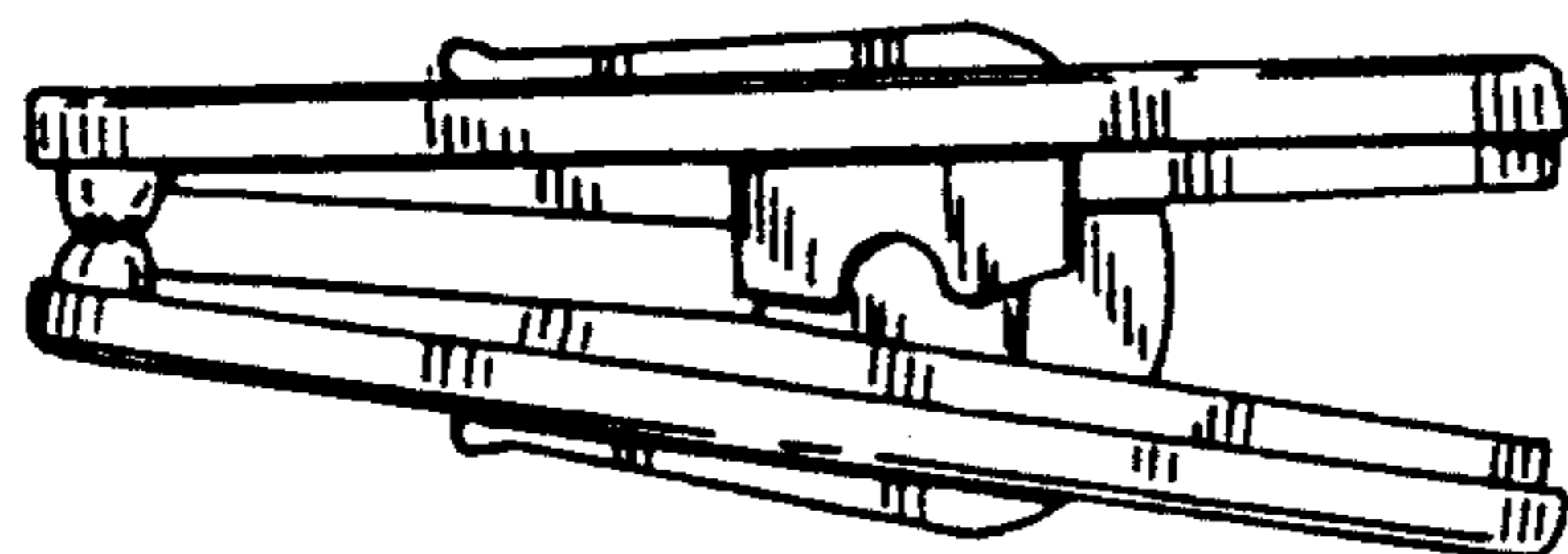

FIG. 6

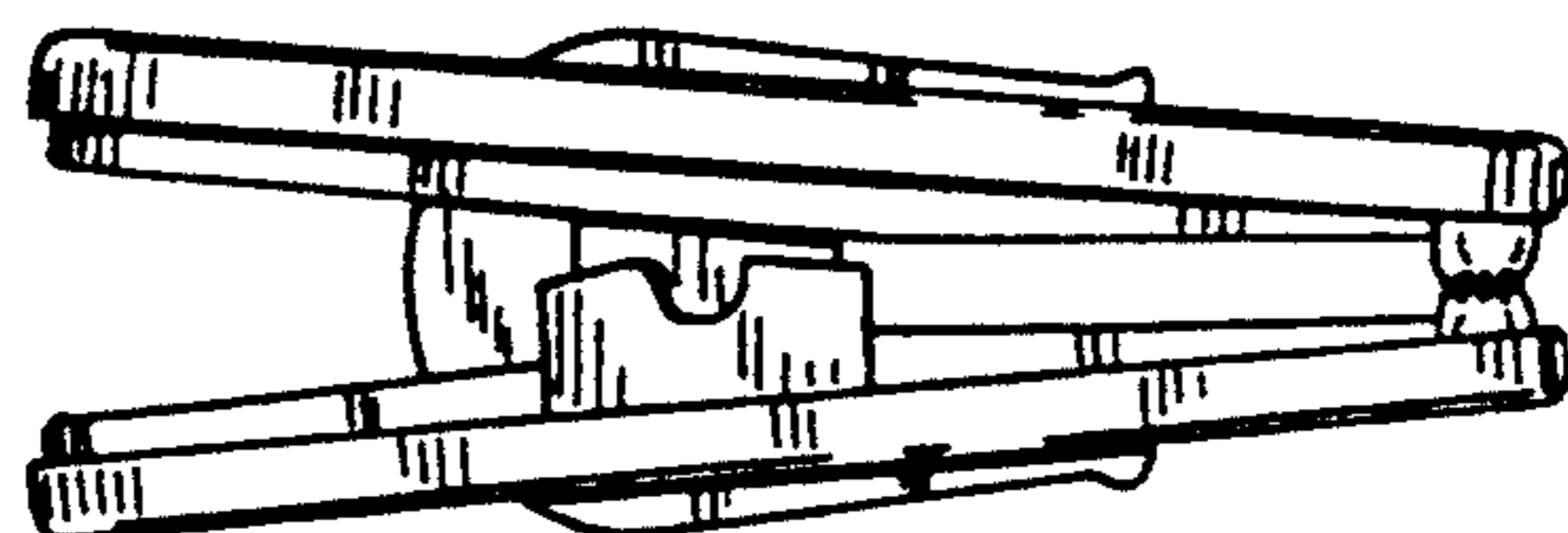

FIG. 7