



US00D348761S

United States Patent [19]

[11] Patent Number: **Des. 348,761**

Castelli et al.

[45] Date of Patent: **** Jul. 12, 1994**

[54] MAIL BOX

D. 335,749 5/1993 Brittain D99/32
D. 338,762 8/1993 Nichols D99/32
D. 338,765 8/1993 Hohlbein D99/32

[76] Inventors: **Rinaldo P. Castelli**, 5427 Alloway St., Orlando, Fla. 32810; **Roy E. Starling**, 720 S. Armitage St., Apopka, Fla. 32703

Primary Examiner—Alan P. Douglas
Assistant Examiner—Jeffrey H. Musgrove
Attorney, Agent, or Firm—William M. Hobby

[**] Term: **14 Years**

[57] **CLAIM**

[21] Appl. No.: **9,777**

The ornamental design for a mail box design, as shown.

[22] Filed: **Jun. 24, 1993**

DESCRIPTION

[52] U.S. Cl. **D99/32**

[58] Field of Search 232/14, 10, 17, 34;
D99/29, 30, 31, 32

FIG. 1 is a front perspective view of our new mail box design;

FIG. 2 is a front elevation;

FIG. 3 is a left side elevation;

FIG. 4 is a right side elevation;

FIG. 5 is a rear elevation;

FIG. 6 is a bottom plan view; and,

FIG. 7 is a top plan view.

[56] **References Cited**

U.S. PATENT DOCUMENTS

D. 291,937 9/1987 Fisher D99/30
D. 333,545 2/1993 Rentz D99/29

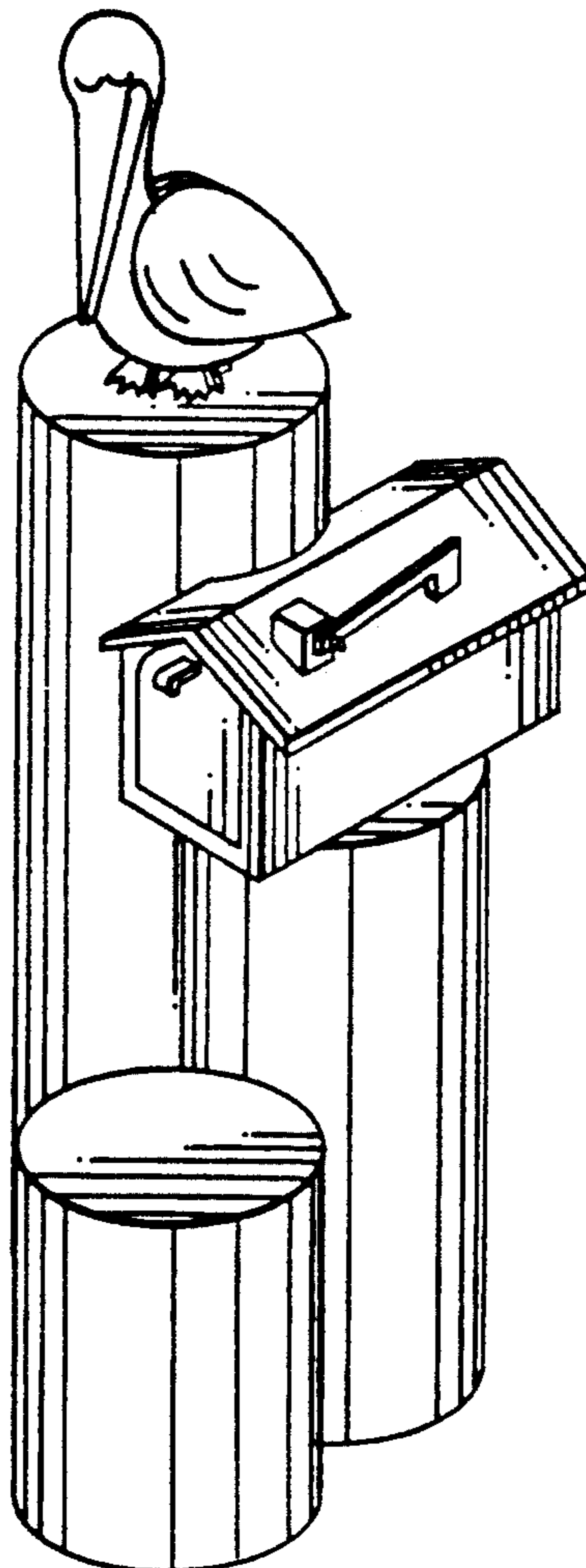

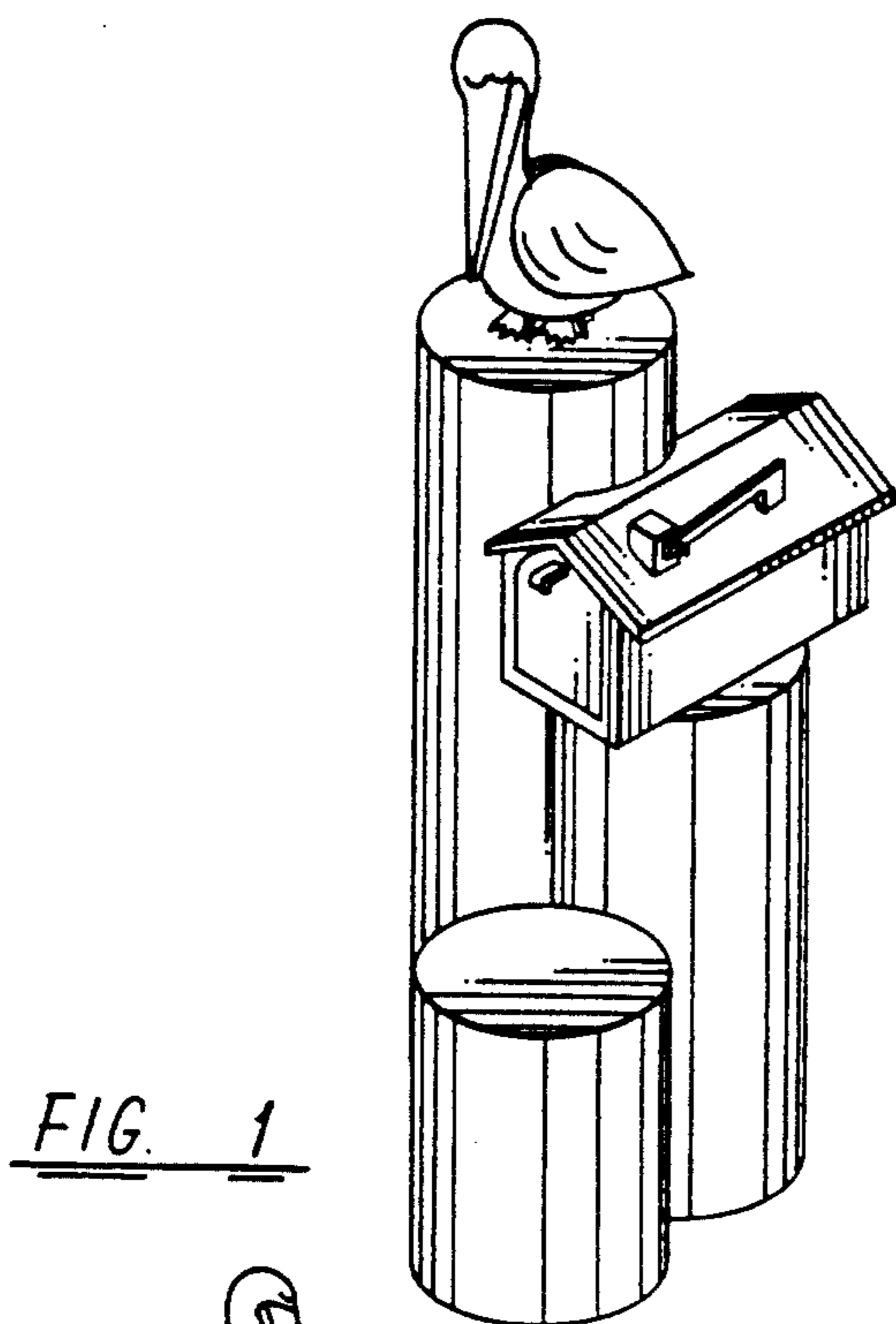

FIG. 1

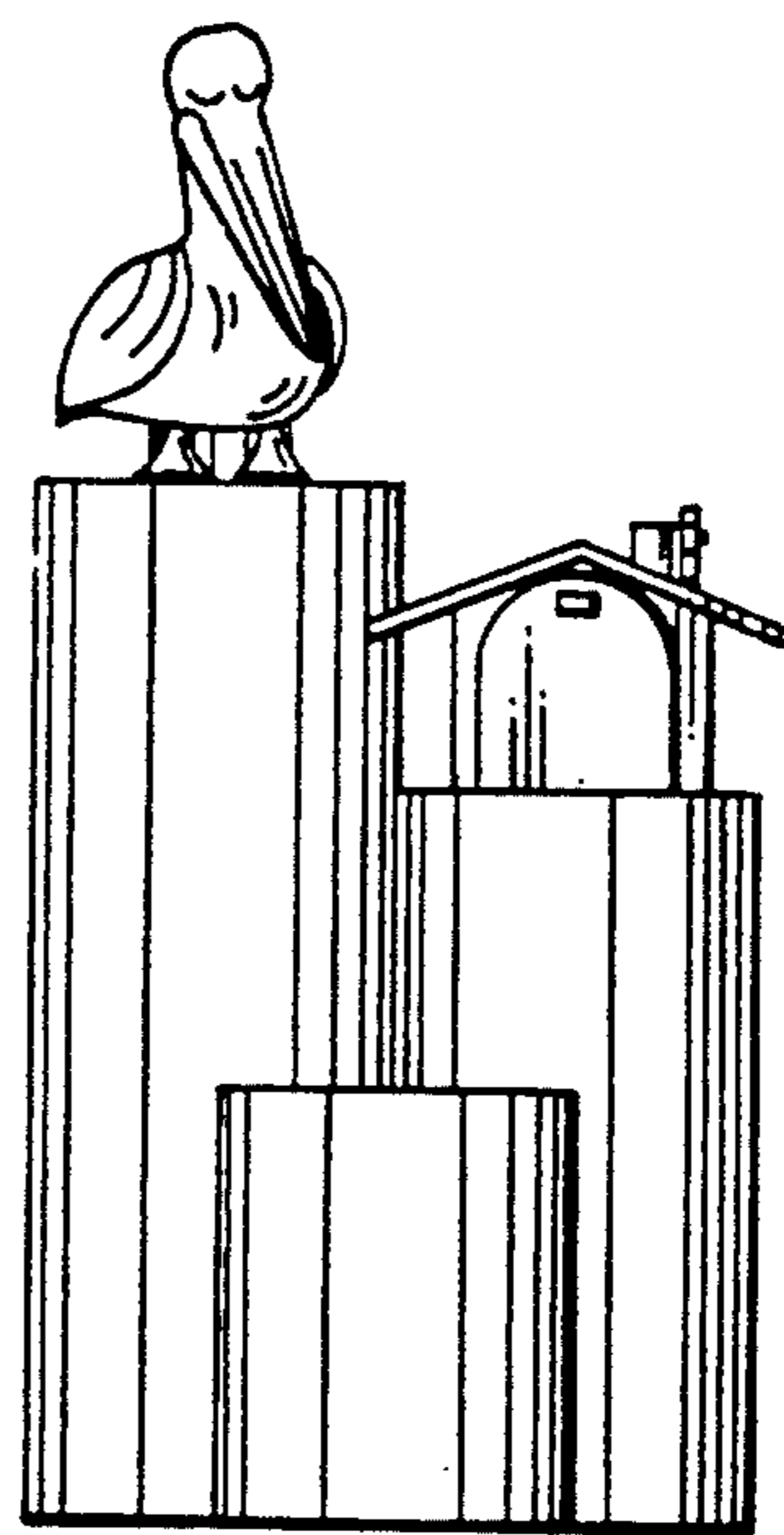

FIG. 2

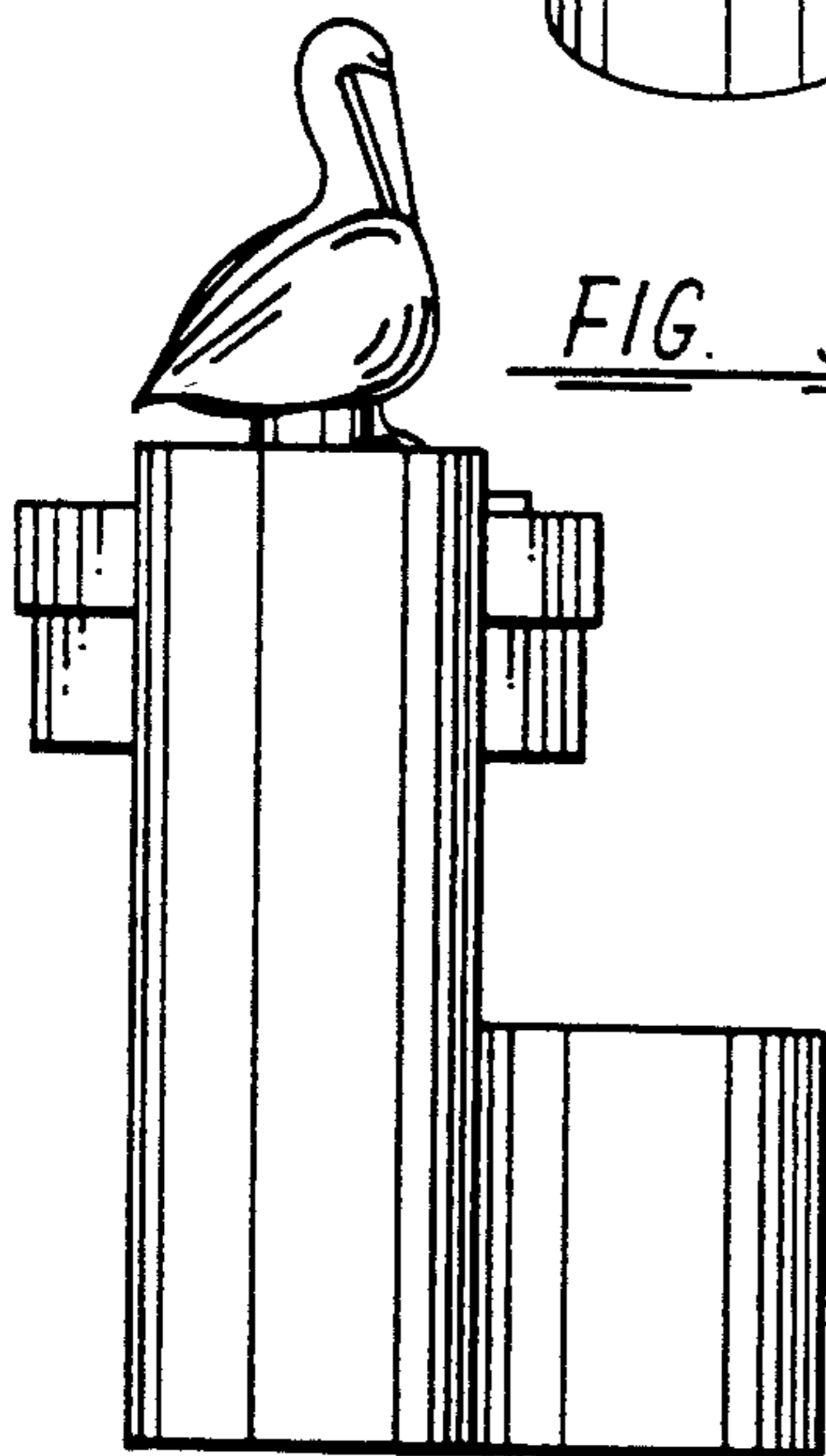

FIG. 3

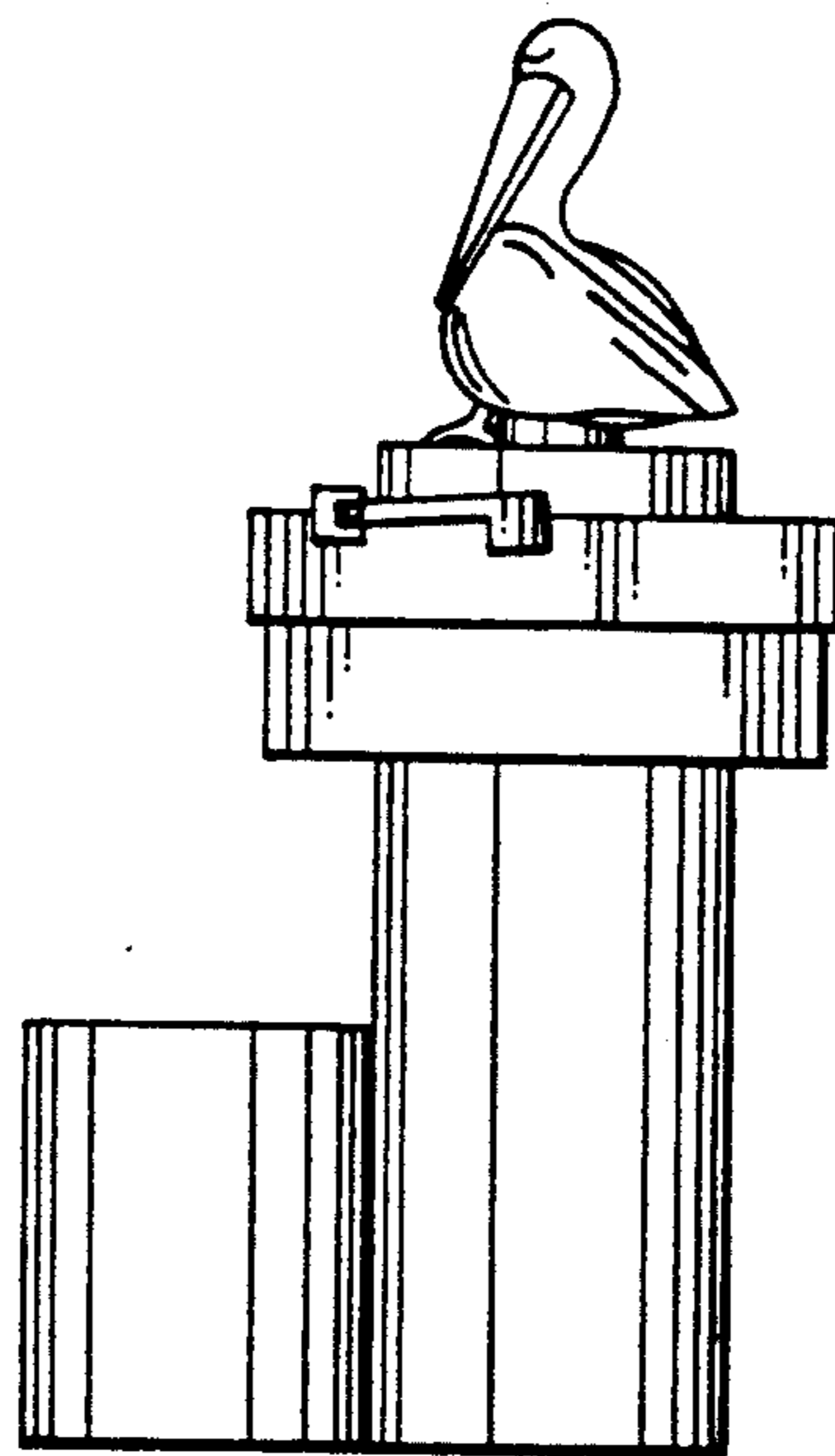

FIG. 4

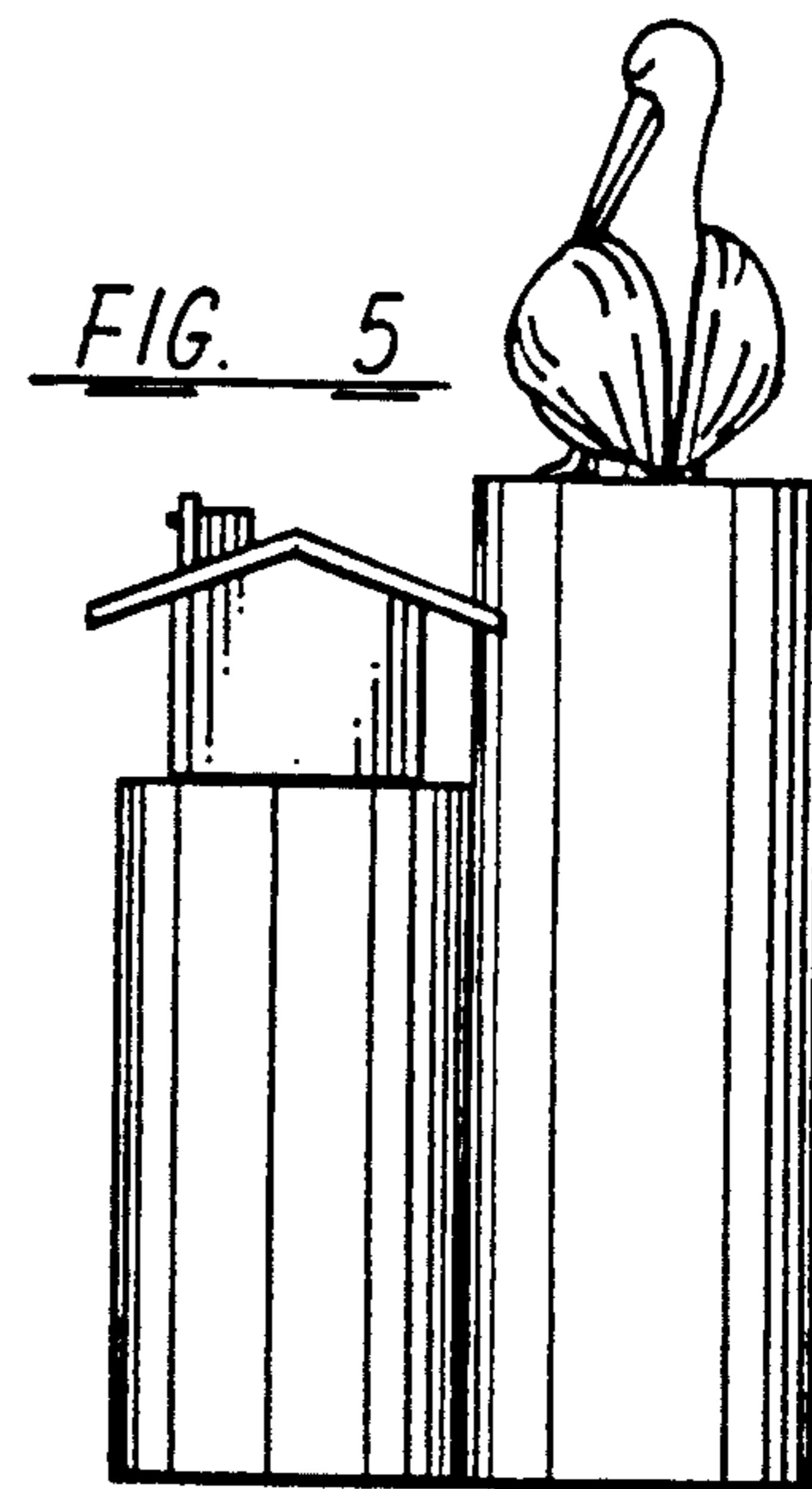

FIG. 5

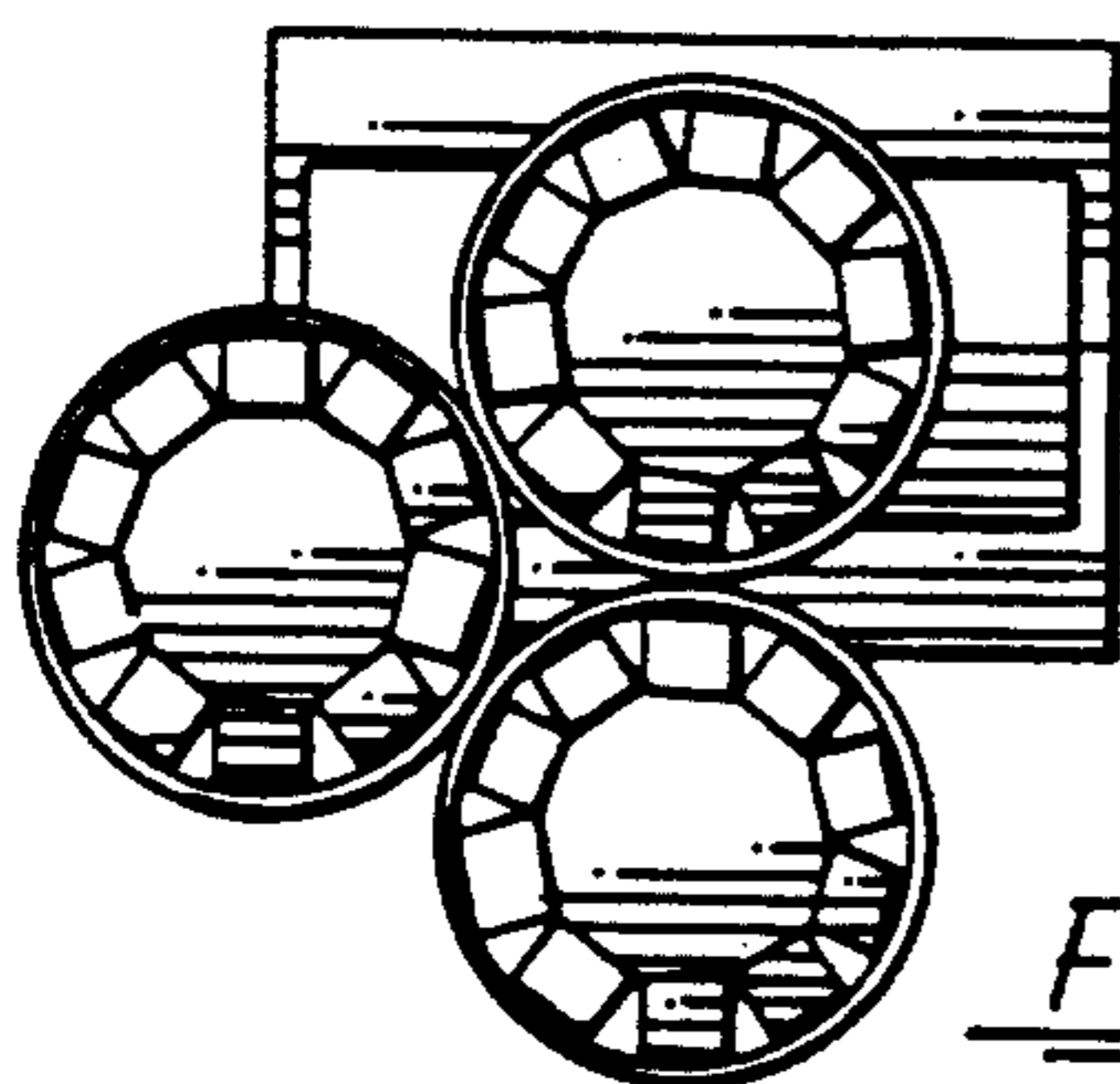

FIG. 6

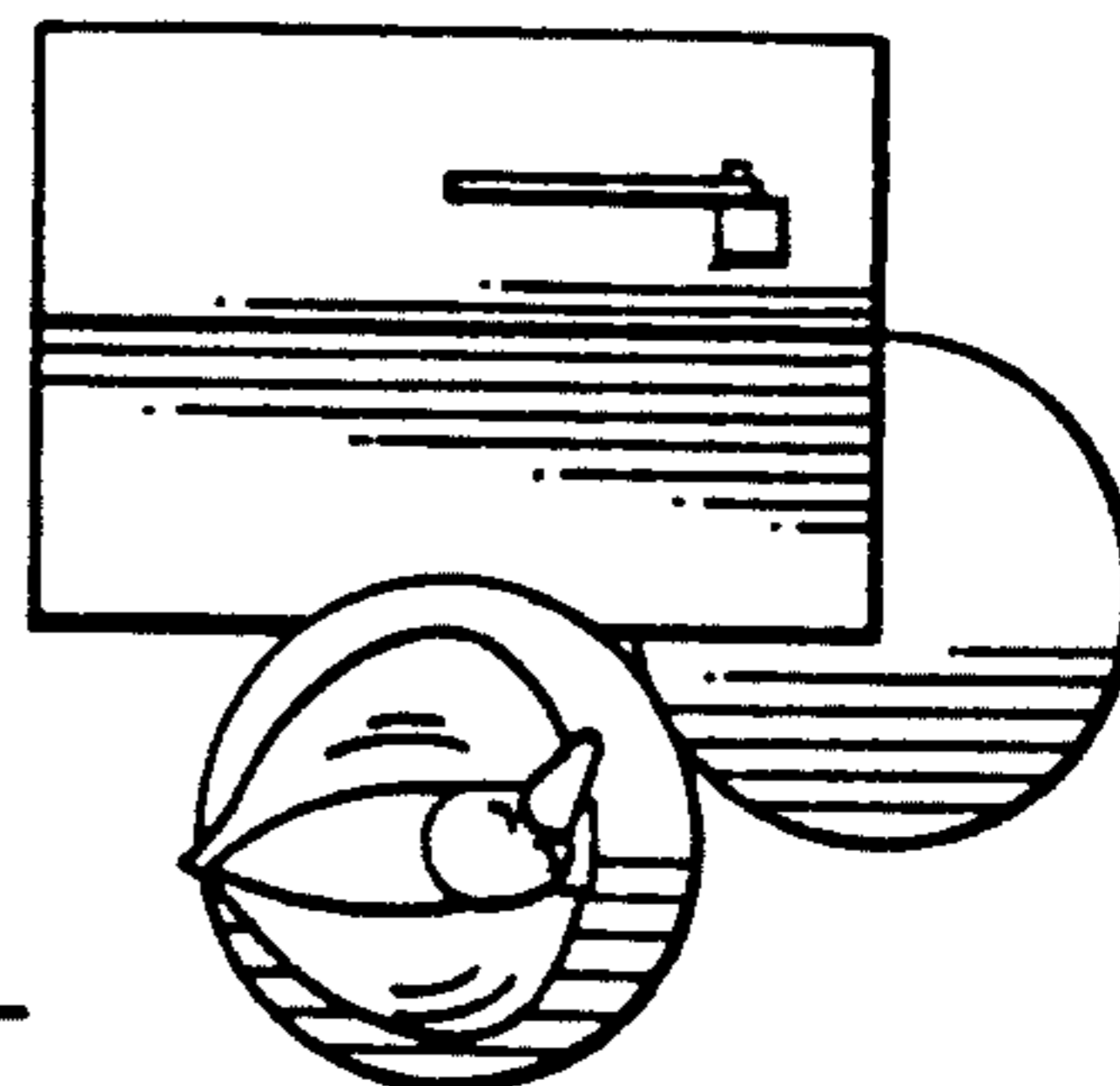

FIG. 7