



US00D348716S

United States Patent [19]

[11] Patent Number: **Des. 348,716**

Sbrocchi

[45] Date of Patent: **** Jul. 12, 1994**

[54] **DECOY ANCHOR**

4,827,653 5/1989 Sewell 43/2 X

[76] Inventor: **Timothy K. Sbrocchi**, 4115 Willis Blvd., Toledo, Ohio 43623

Primary Examiner—A. Hugo Word
Assistant Examiner—Doris V. Coles
Attorney, Agent, or Firm—Marshall & Melhorn

[**] Term: **14 Years**

[57] **CLAIM**

[21] Appl. No.: **2,624**

The ornamental design for a decoy anchor, as shown and described.

[22] Filed: **Dec. 14, 1992**

[52] U.S. Cl. **D22/125**

DESCRIPTION

[58] Field of Search 43/1, 2, 3; 242/107.6, 242/107.7; D22/125

FIG. 1 is a perspective view of a decoy anchor embodying the features of the present invention;
FIG. 2 is a front view thereof;
FIG. 3 is a right side elevational view thereof;
FIG. 4 is a left side elevational view thereof;
FIG. 5 is a rear elevational view thereof;
FIG. 6 is a top plan view thereof; and,
FIG. 7 is a bottom plan view thereof.
The broken line showing of environment in FIG. 1 is for illustrative purposes only and forms no part of the claimed design.

[56] **References Cited**

U.S. PATENT DOCUMENTS

3,000,128	9/1961	McAda	43/3
3,798,820	3/1974	Dye	43/3
3,909,970	10/1975	McGregor	43/3
4,340,192	7/1982	Burris, III	43/3
4,674,219	6/1987	Chargo et al.	43/3
4,757,630	7/1988	Torberg	43/3

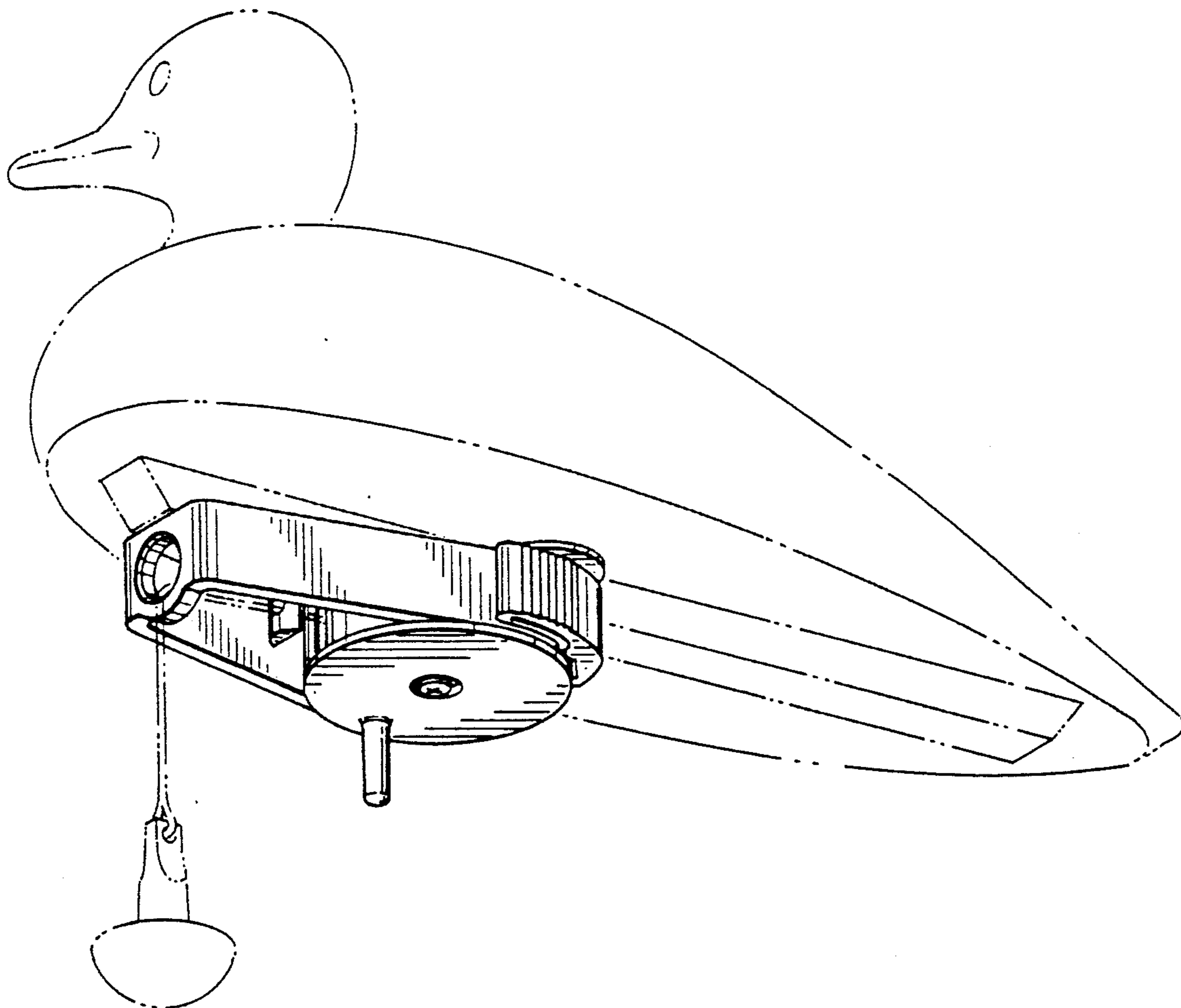

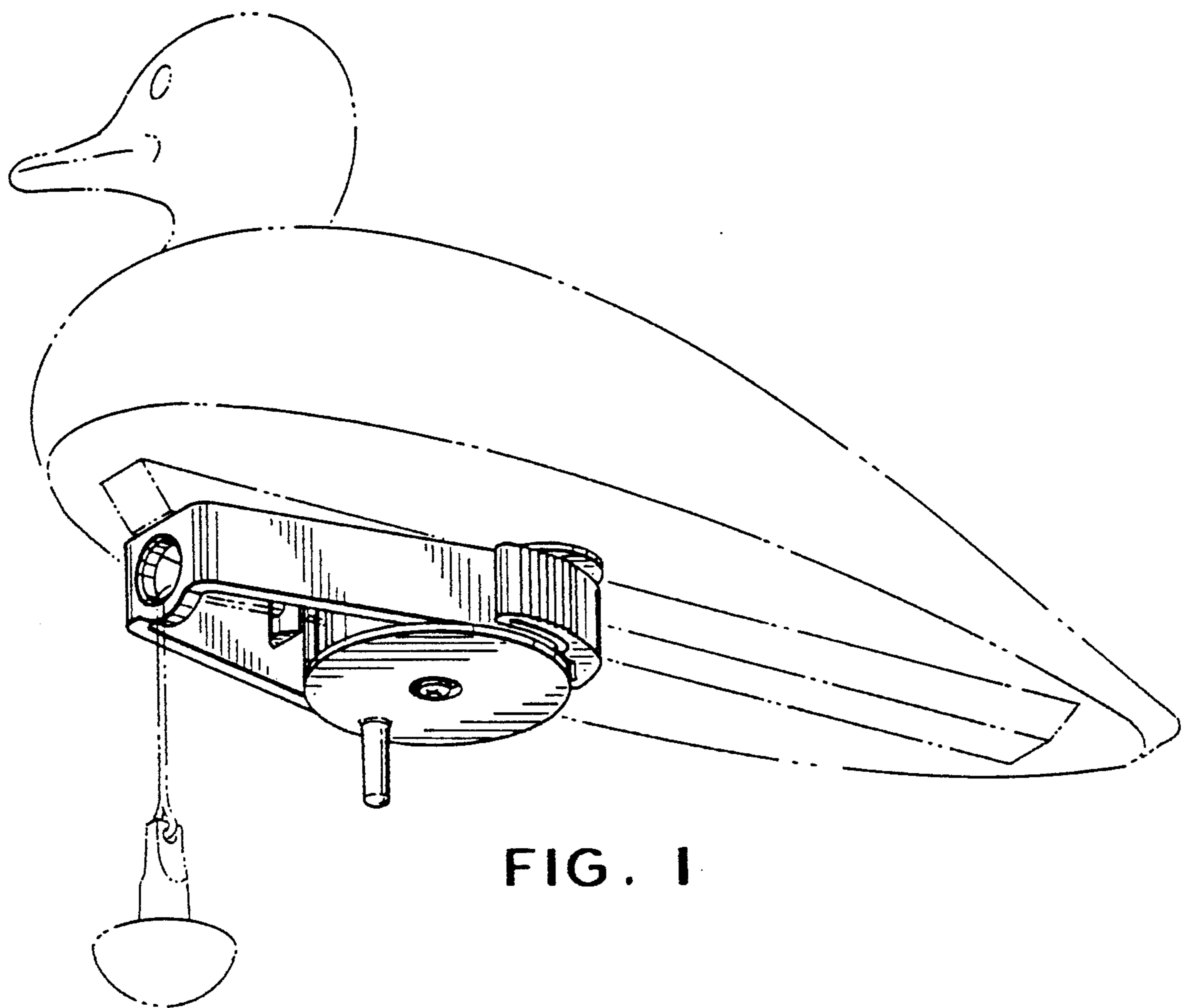

FIG. 1

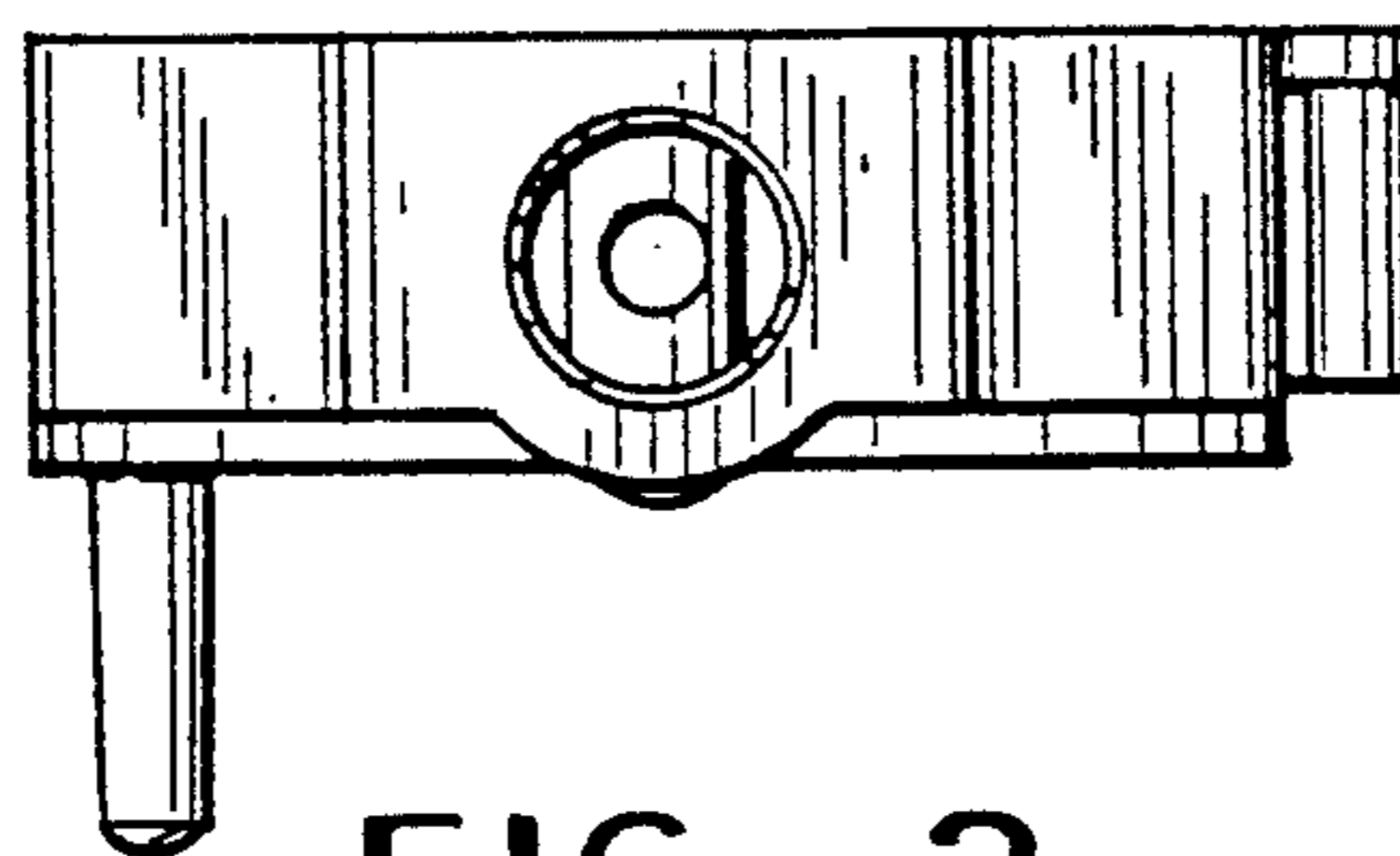

FIG. 2

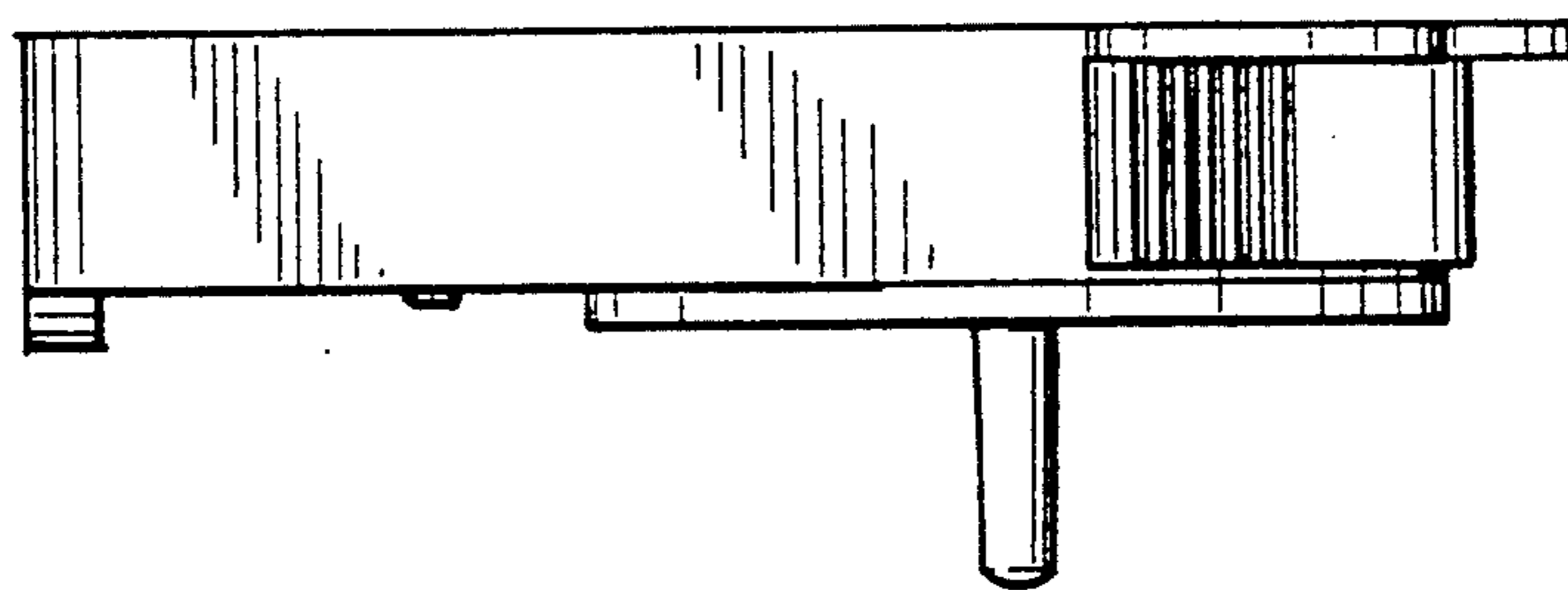

FIG. 3

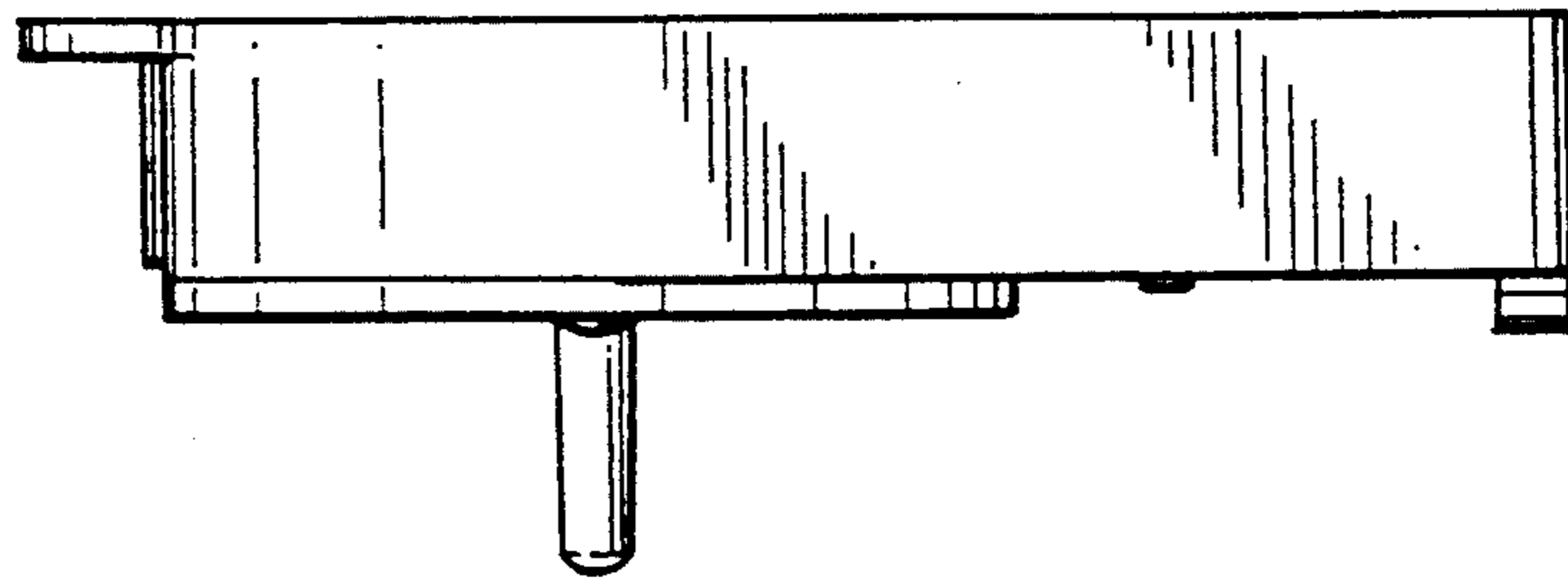

FIG. 4

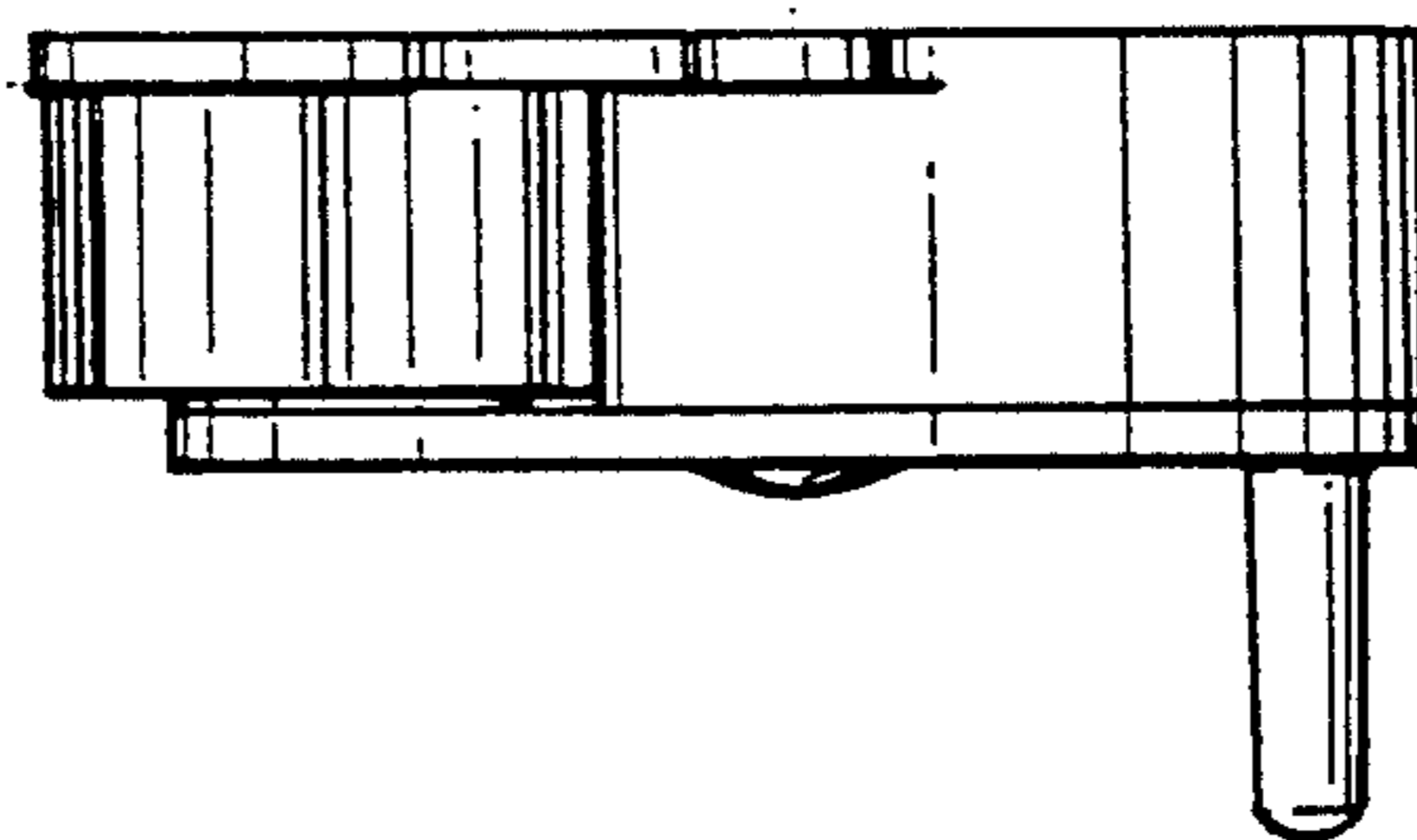

FIG. 5

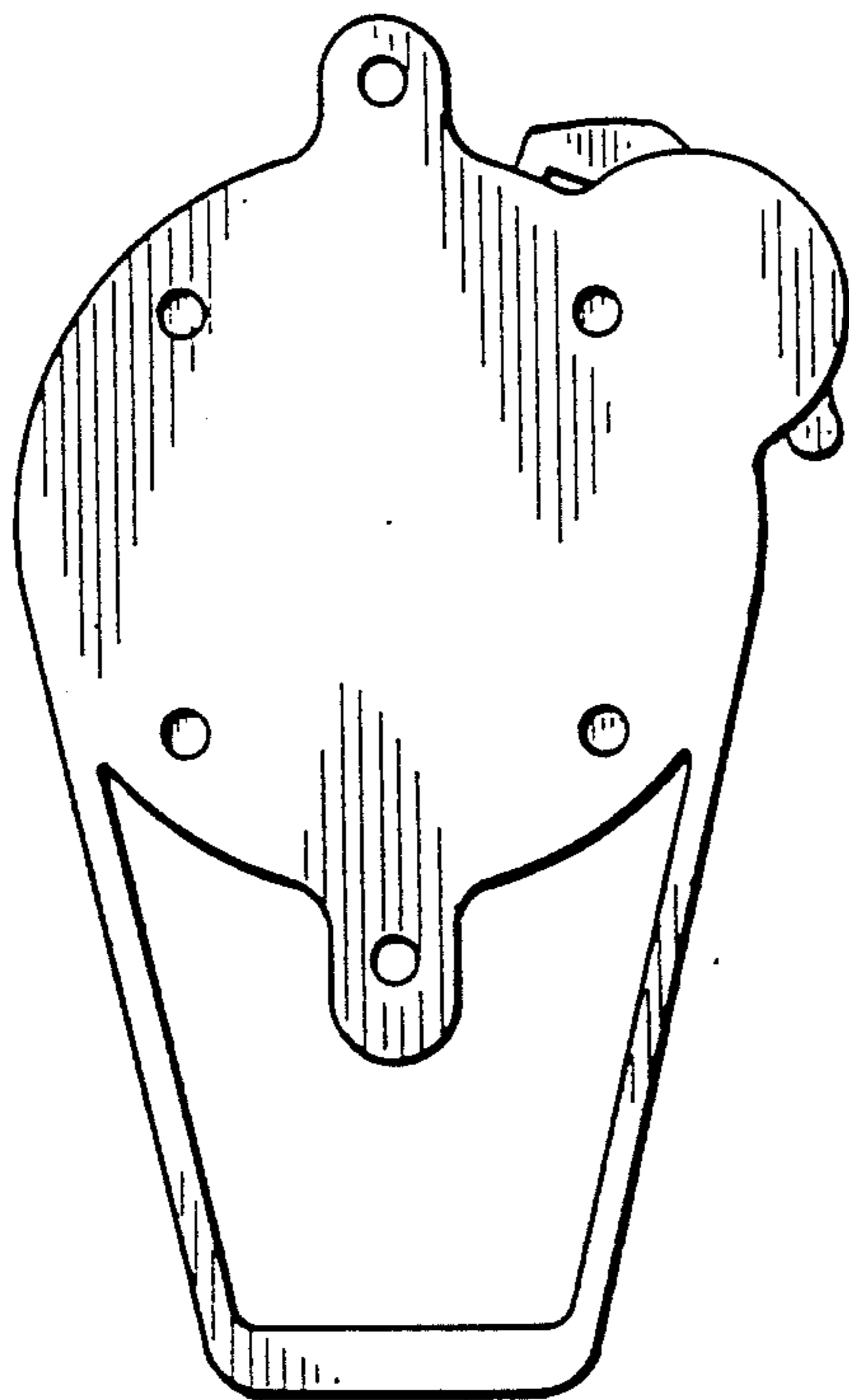

FIG. 6

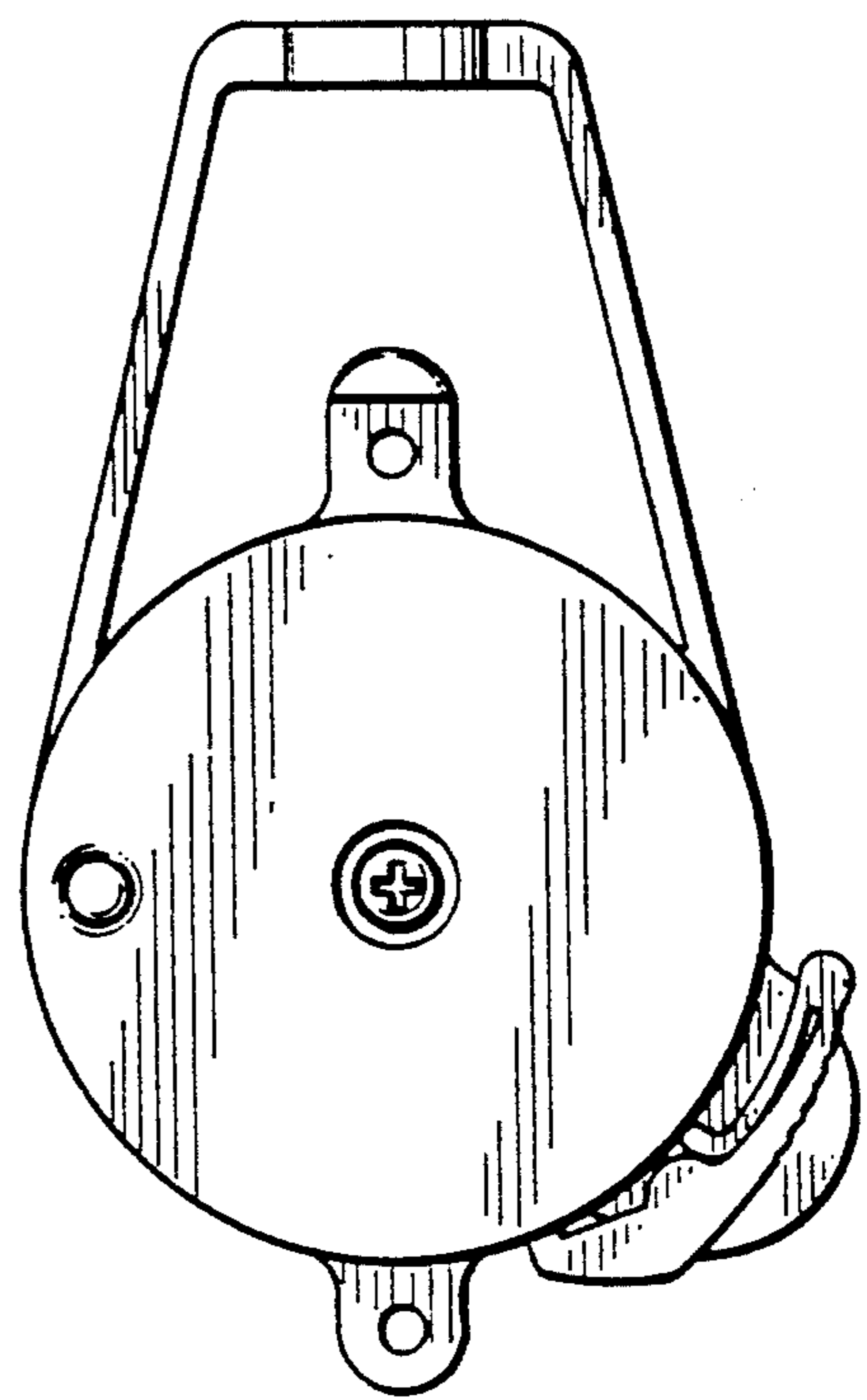

FIG. 7