



US00D348689S

United States Patent [19]

[11] Patent Number: Des. 348,689

Kikuchi et al.

[45] Date of Patent: ** Jul. 12, 1994

[54] TONER CARTRIDGE

4,732,277 3/1988 Smith 222/DIG. 1 X

[75] Inventors: Hiroshi Kikuchi; Yukio Ota; Hisao Ono, all of Tokyo, Japan

OTHER PUBLICATIONS

[73] Assignee: Oki Electric Industry Co., Ltd., Tokyo, Japan

Catalogue "Count On Allstate As You Alternative Source For Copier Supplies." By Allstate Office Supply Corporation.

[**] Term: 14 Years

Primary Examiner—Alan P. Douglas
Assistant Examiner—Robert M. Spear
Attorney, Agent, or Firm—Wenderoth, Lind & Ponack

[21] Appl. No.: 876,463

[22] Filed: Apr. 30, 1992

[57] CLAIM

[30] Foreign Application Priority Data

The ornamental design for a toner cartridge, as shown and described.

Dec. 20, 1991 [JP] Japan 38233/1991

[52] U.S. Cl. D18/43

DESCRIPTION

[58] Field of Search 118/657; 141/1; 206/216, 446, 461, 527; 222/166, 240, 325, 541, DIG. 1; 355/260, 298; D18/43; D19/66, 70, 71

FIG. 1 is a left side, top and front perspective view of a toner cartridge showing our new design; FIG. 2 is a front elevational view thereof; FIG. 3 is a rear elevational view thereof; FIG. 4 is a top plan view thereof; FIG. 5 is a bottom view thereof; FIG. 6 is a left side elevational view thereof; FIG. 7 is a right side elevational view thereof; and, FIG. 8 is a perspective view showing the toner cartridge in a printer.

[56] References Cited

U.S. PATENT DOCUMENTS

- D. 208,377 8/1967 Wagner et al. D58/17
- D. 218,805 9/1970 Stone D9/224
- D. 218,806 9/1970 Berg D9/224
- D. 240,201 6/1976 Avolio et al. D9/216
- D. 252,557 8/1979 Walker et al. D9/216
- D. 260,843 9/1981 Laird et al. D7/77
- D. 284,865 7/1986 Gendron D16/32
- D. 321,716 11/1991 Kikuchi et al. D18/43

The broken lines showing a printer in FIG. 8 are for illustrative purposes only and form no part of the claimed design.

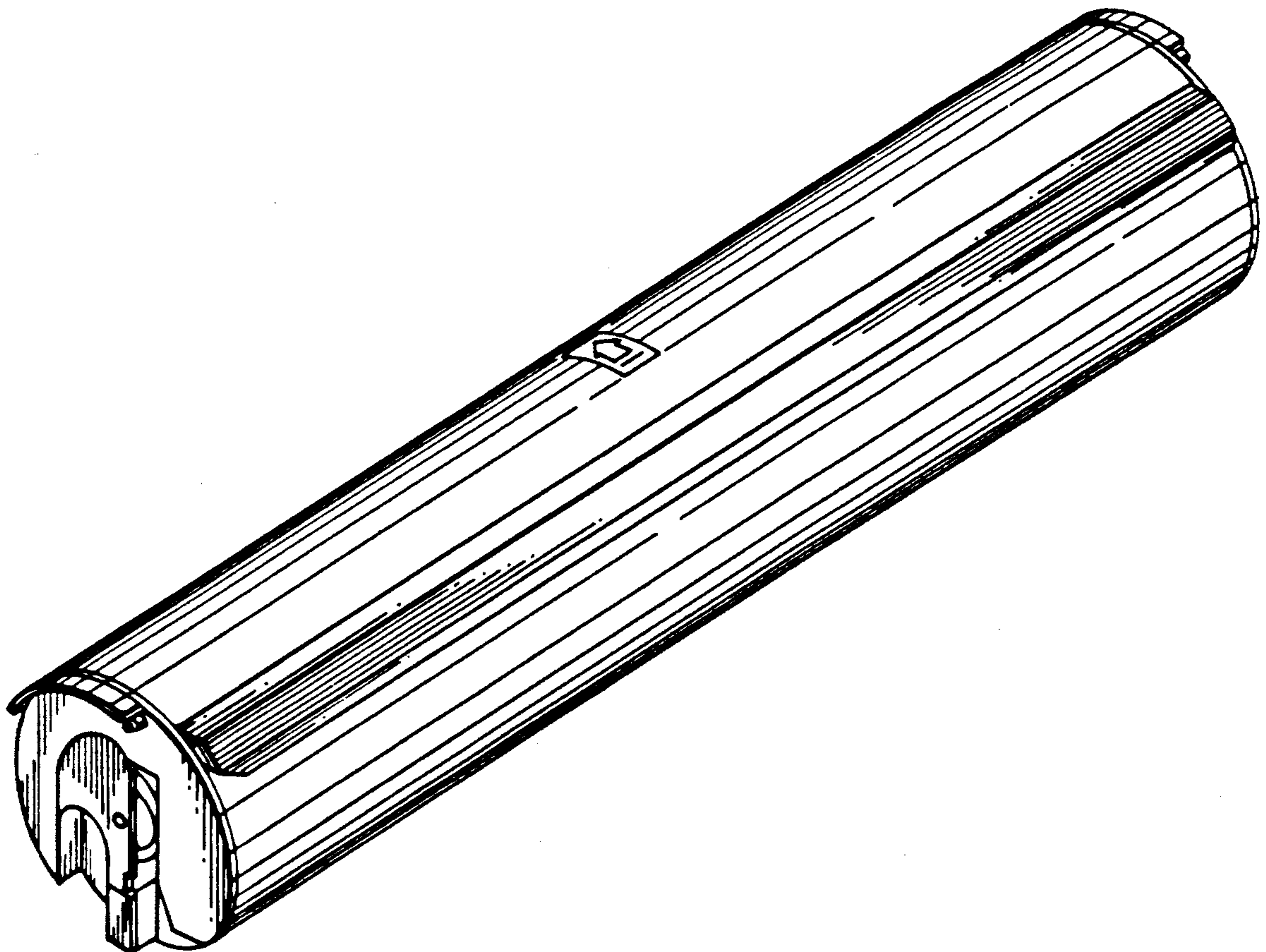

Fig. 1

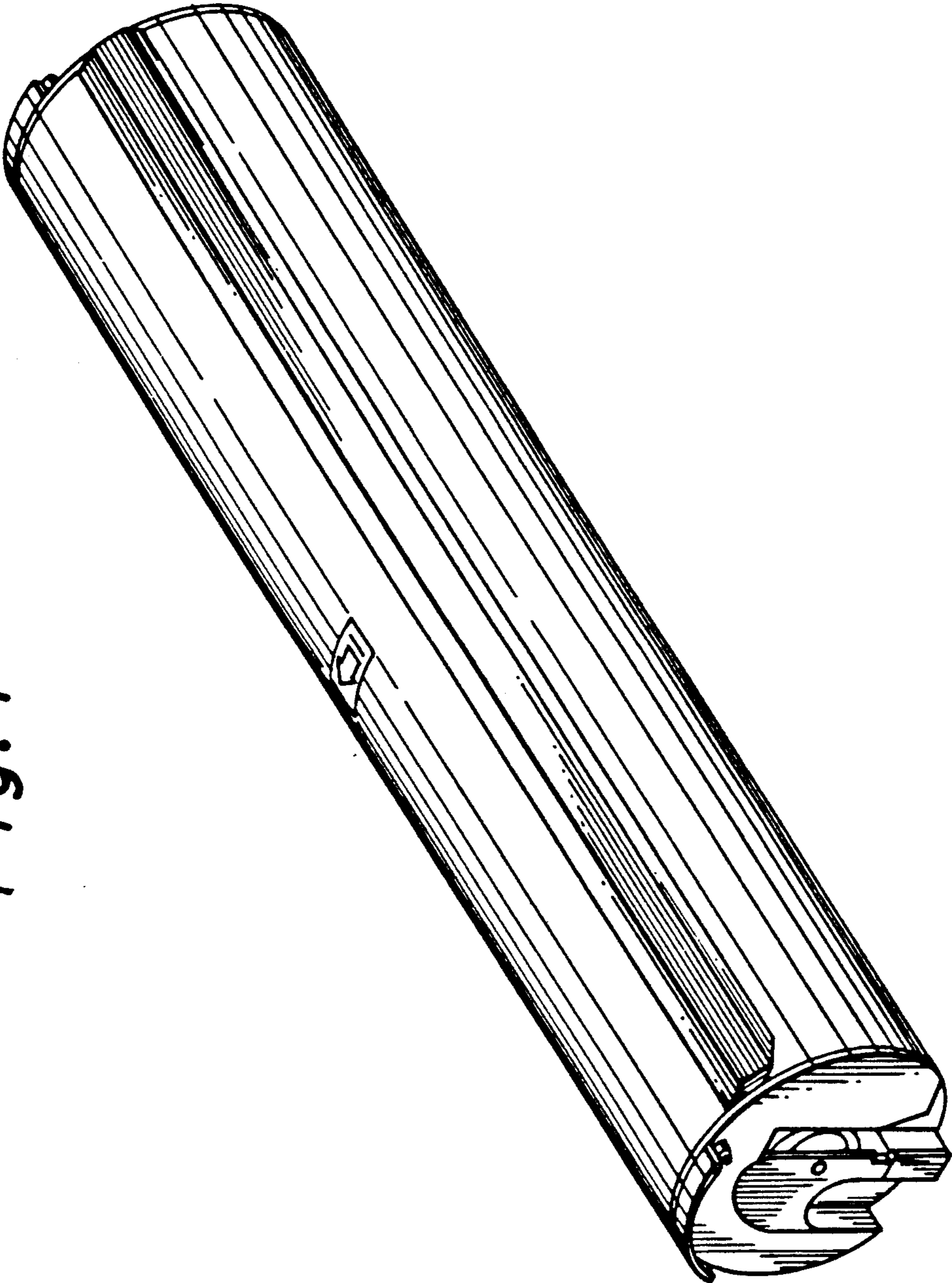

Fig. 2

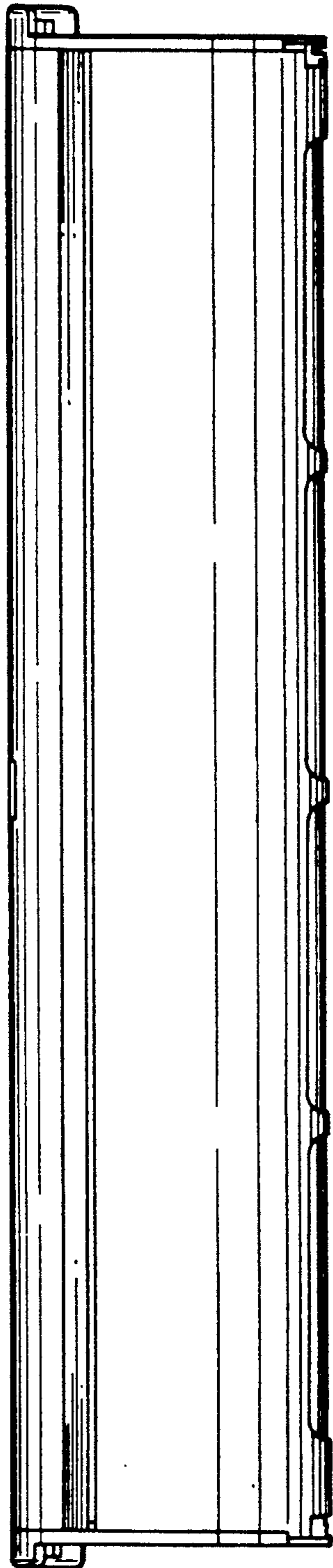

Fig. 3

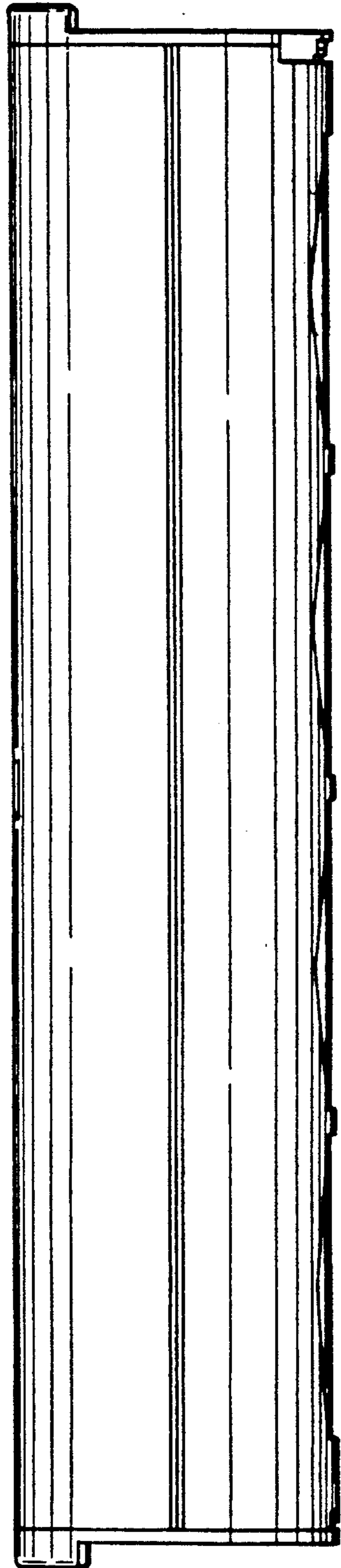

Fig. 4

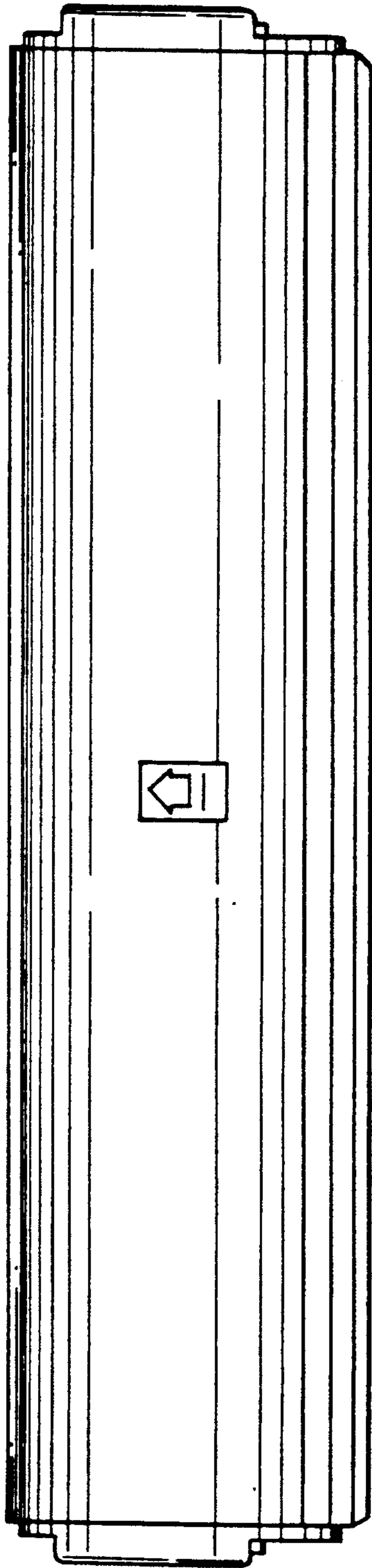

Fig. 5

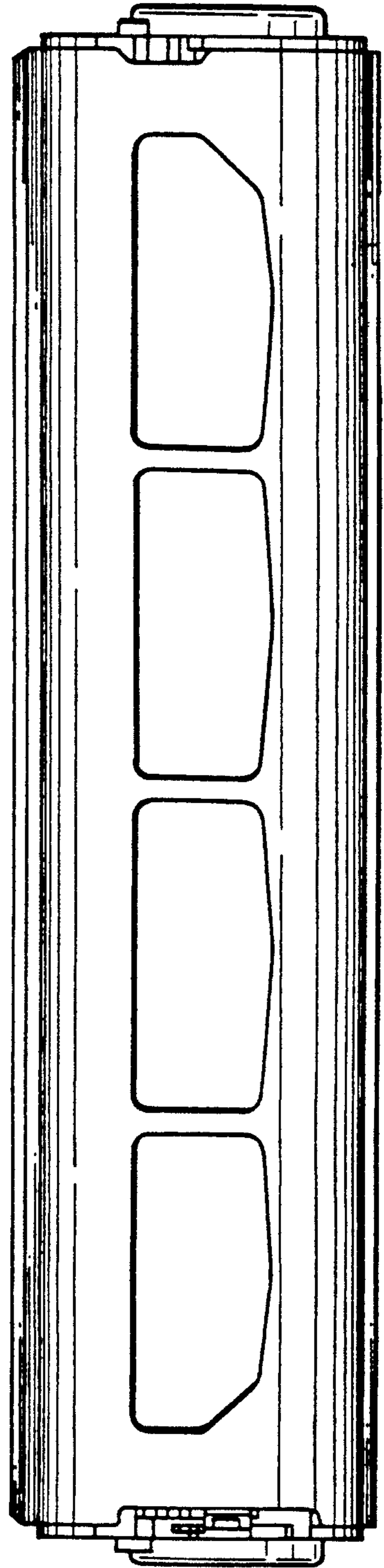

Fig. 6

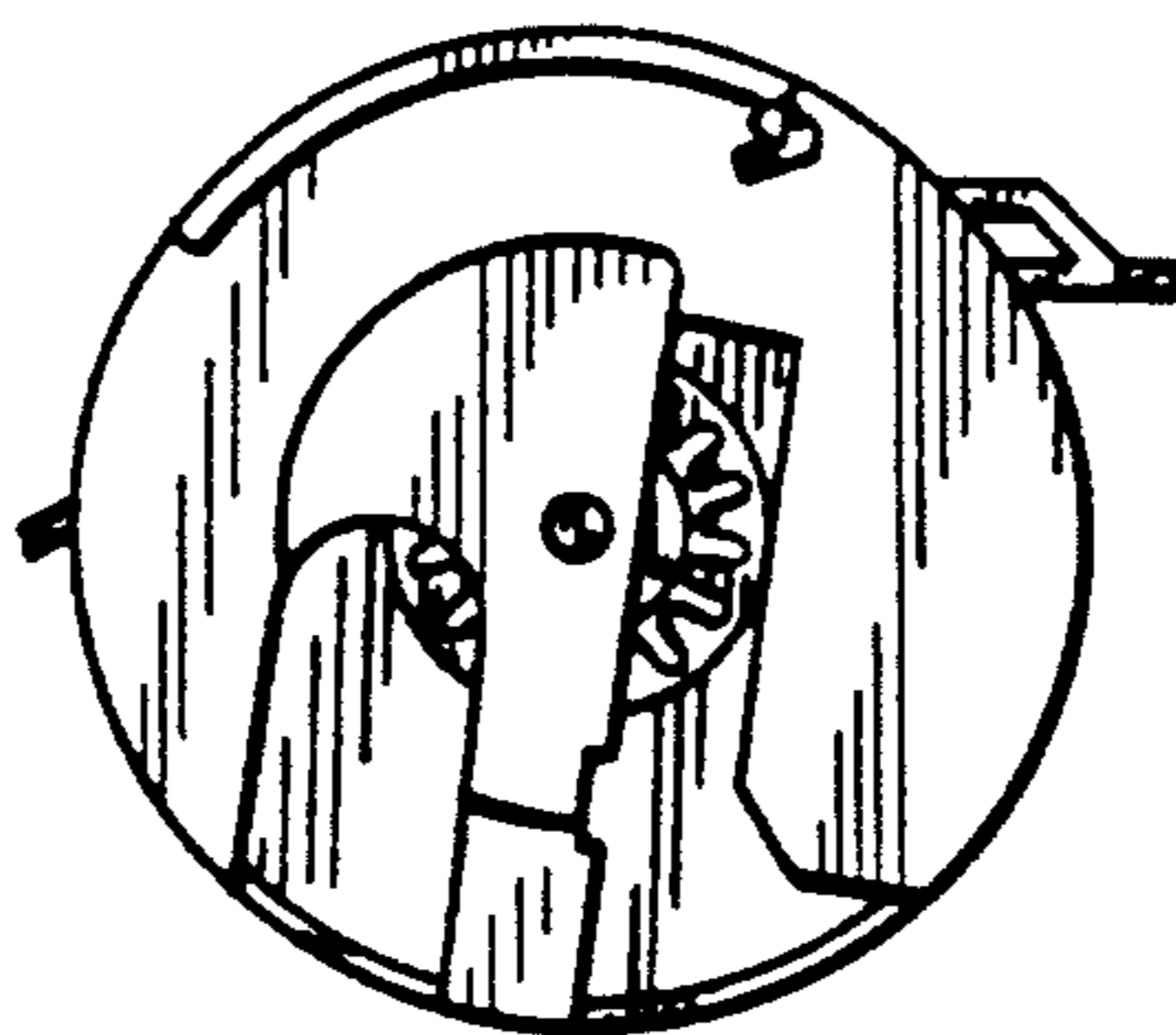

Fig. 7

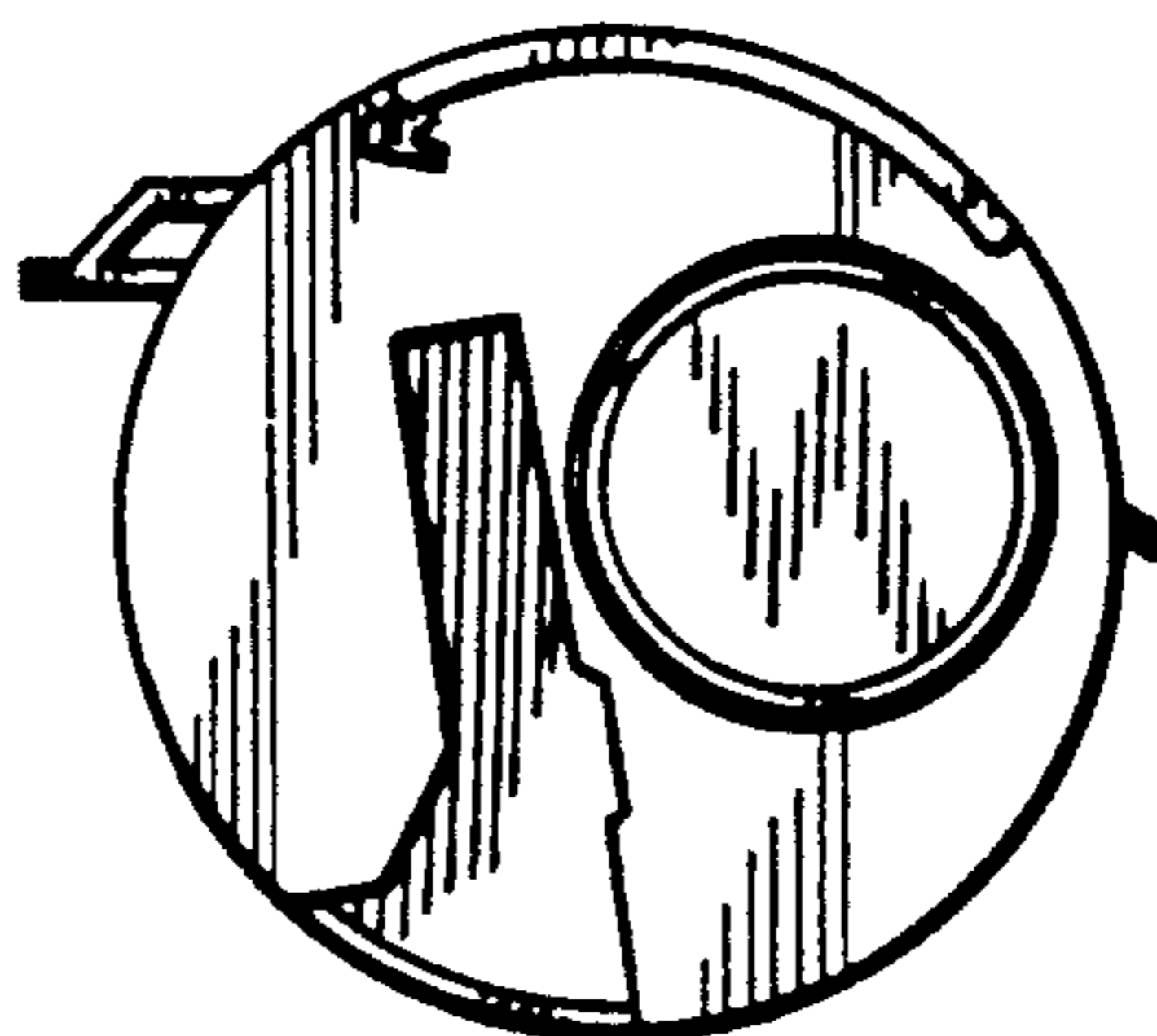

Fig. 8

