



US00D348661S

# United States Patent [19]

[11] Patent Number: Des. 348,661

Hansen et al.

[45] Date of Patent: \*\* Jul. 12, 1994

## [54] TOUCH PANEL KEYBOARD

## OTHER PUBLICATIONS

[75] Inventors: Peter K. Hansen; Lars Kragh, both of Stamford, Conn.

M9006877-Aug. 1991-Germany-Specification D14-100.

[73] Assignee: Trinitech Systems Inc., Stamford, Conn.

Primary Examiner—Wallace R. Burke  
Assistant Examiner—Freda S. Nunn  
Attorney, Agent, or Firm—Ohlandt, Greeley & Ruggiero

[\*\*] Term: 14 Years

## [57] CLAIM

The ornamental design for a touch panel keyboard, as shown and described.

[21] Appl. No.: 4,854

## DESCRIPTION

[22] Filed: Feb. 12, 1993

[52] U.S. Cl. .... D14/115

[58] Field of Search ..... 235/145 A, 145 R;  
364/708.1, 709.04, 709.12; 345/173; 178/18, 19;  
D14/100, 101, 106, 113, 115; D18/1, 7; D19/76

FIG. 1 is a reduced perspective view of a touch panel keyboard showing my new design;  
FIG. 2 is a rear elevation view thereof;  
FIG. 3 is a top view thereof;  
FIG. 4 is a front elevation view thereof;  
FIG. 5 is a bottom view thereof;  
FIG. 6 is a side elevation view thereof;  
FIG. 7 is a side elevation view of the other side thereof;  
FIG. 8 is a reduced perspective view of a second embodiment thereof;  
FIG. 9 is a rear elevation view thereof;  
FIG. 10 is a top view thereof;  
FIG. 11 is a front elevation view thereof;  
FIG. 12 is a bottom view thereof;  
FIG. 13 is a side elevation view thereof; and,  
FIG. 14 is a side elevation view of the other side thereof.

## [56] References Cited

### U.S. PATENT DOCUMENTS

D. 307,134 4/1990 Makidera ..... D14/100  
D. 315,549 3/1991 Clough et al. .... D14/100  
D. 319,434 8/1991 Lund ..... D14/100  
D. 340,701 10/1993 Takeuchi ..... D14/100

### FOREIGN PATENT DOCUMENTS

803268 12/1990 Japan ..... D14/i

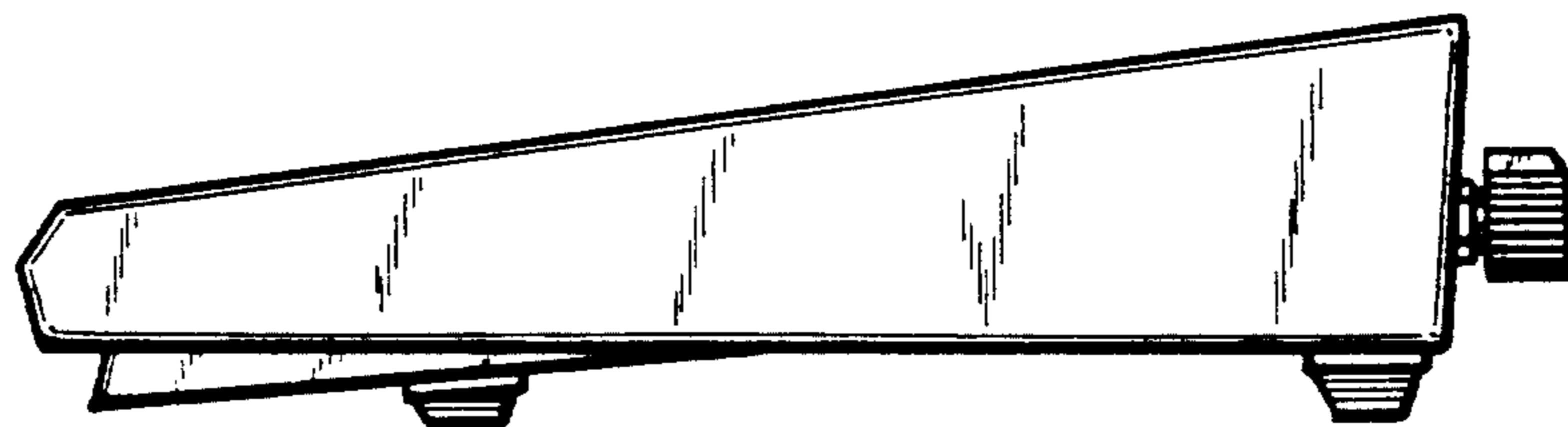
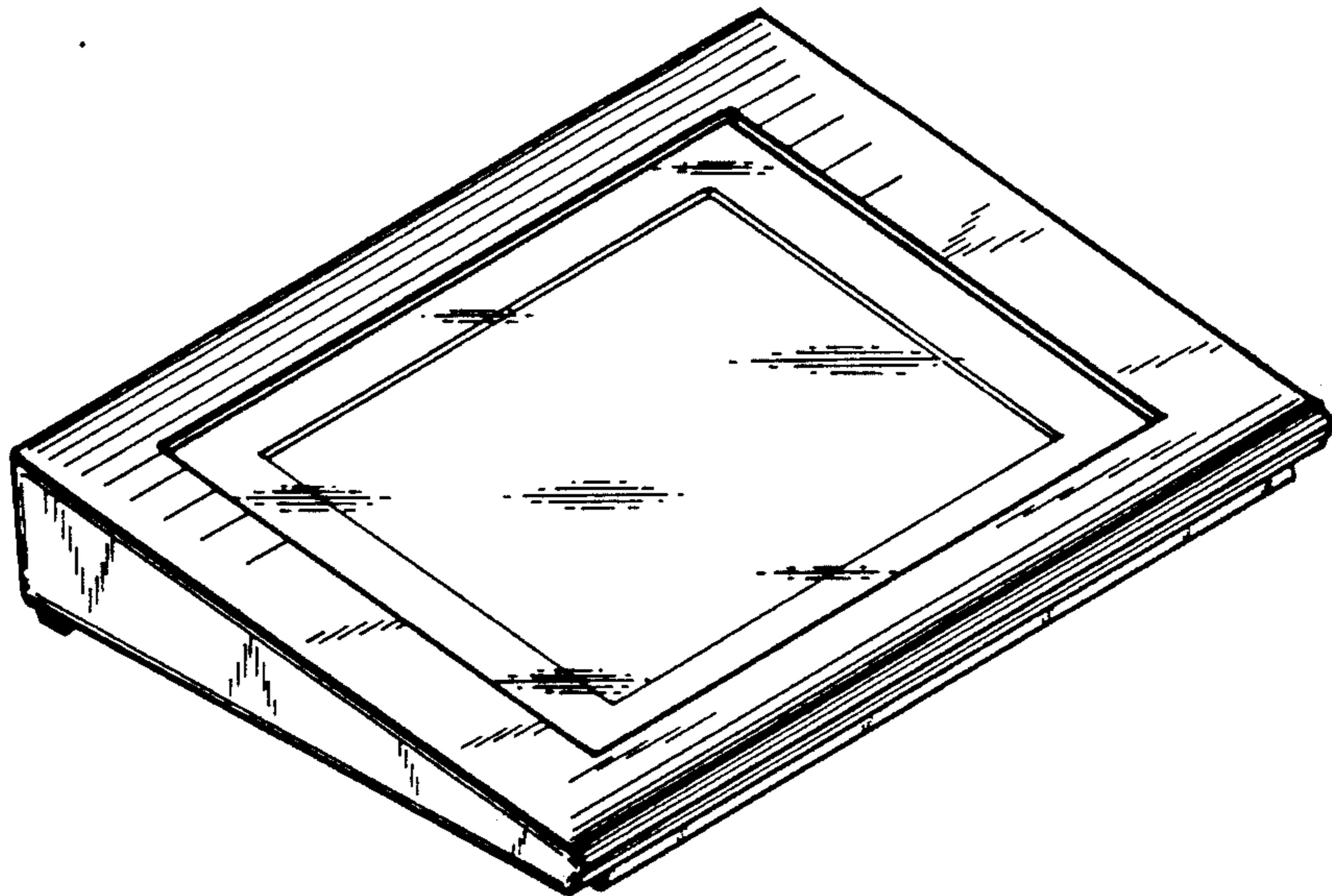

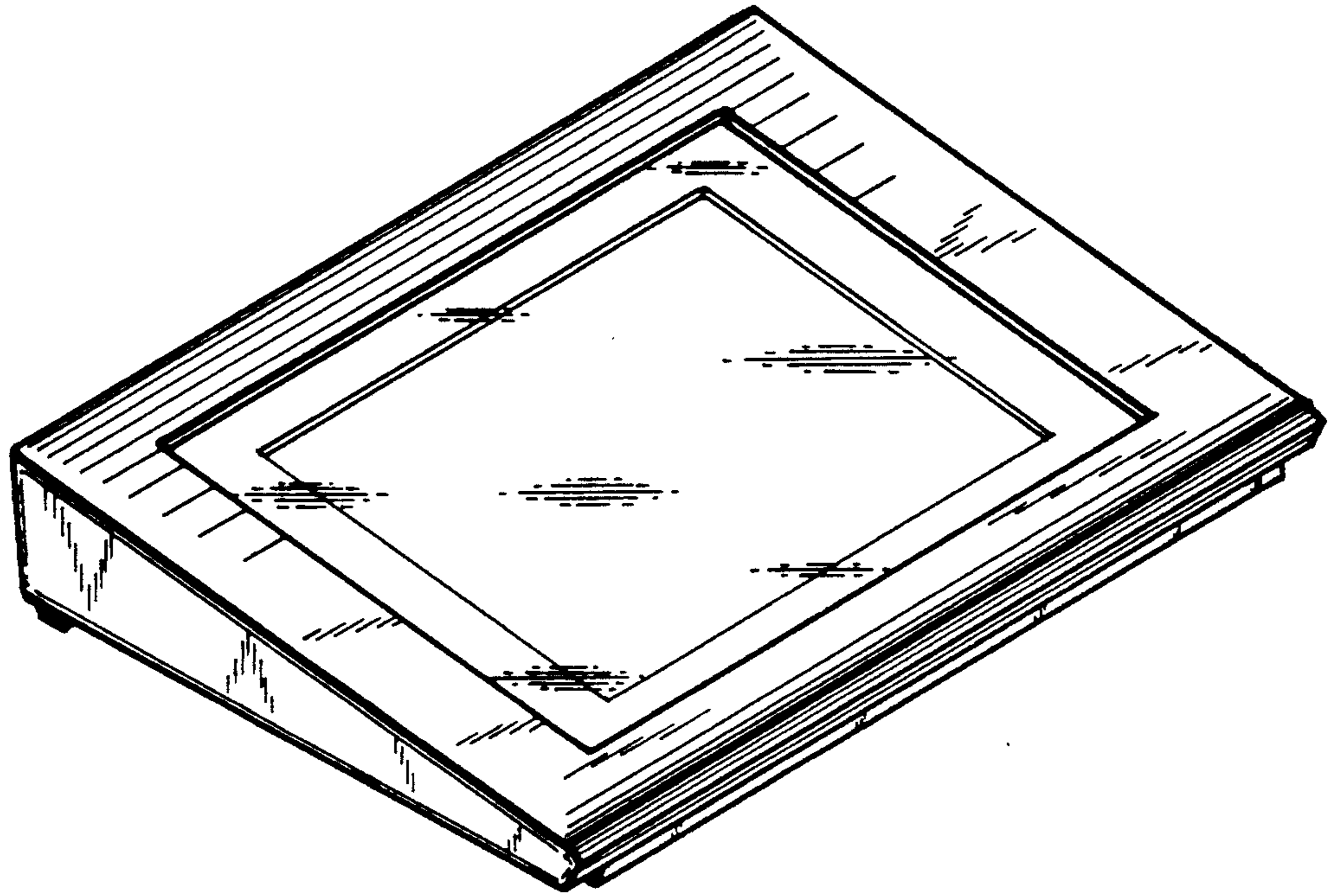

FIG. 1

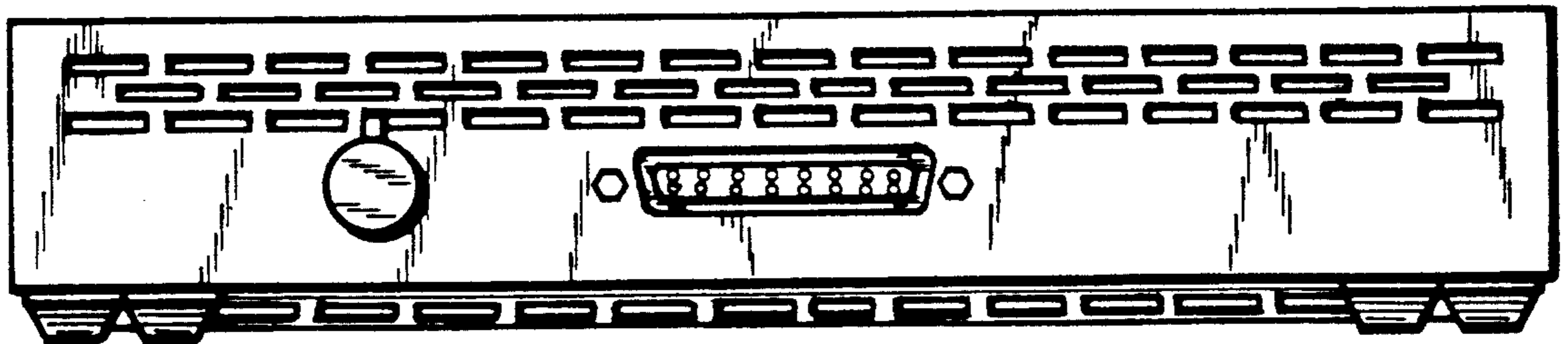

FIG. 2

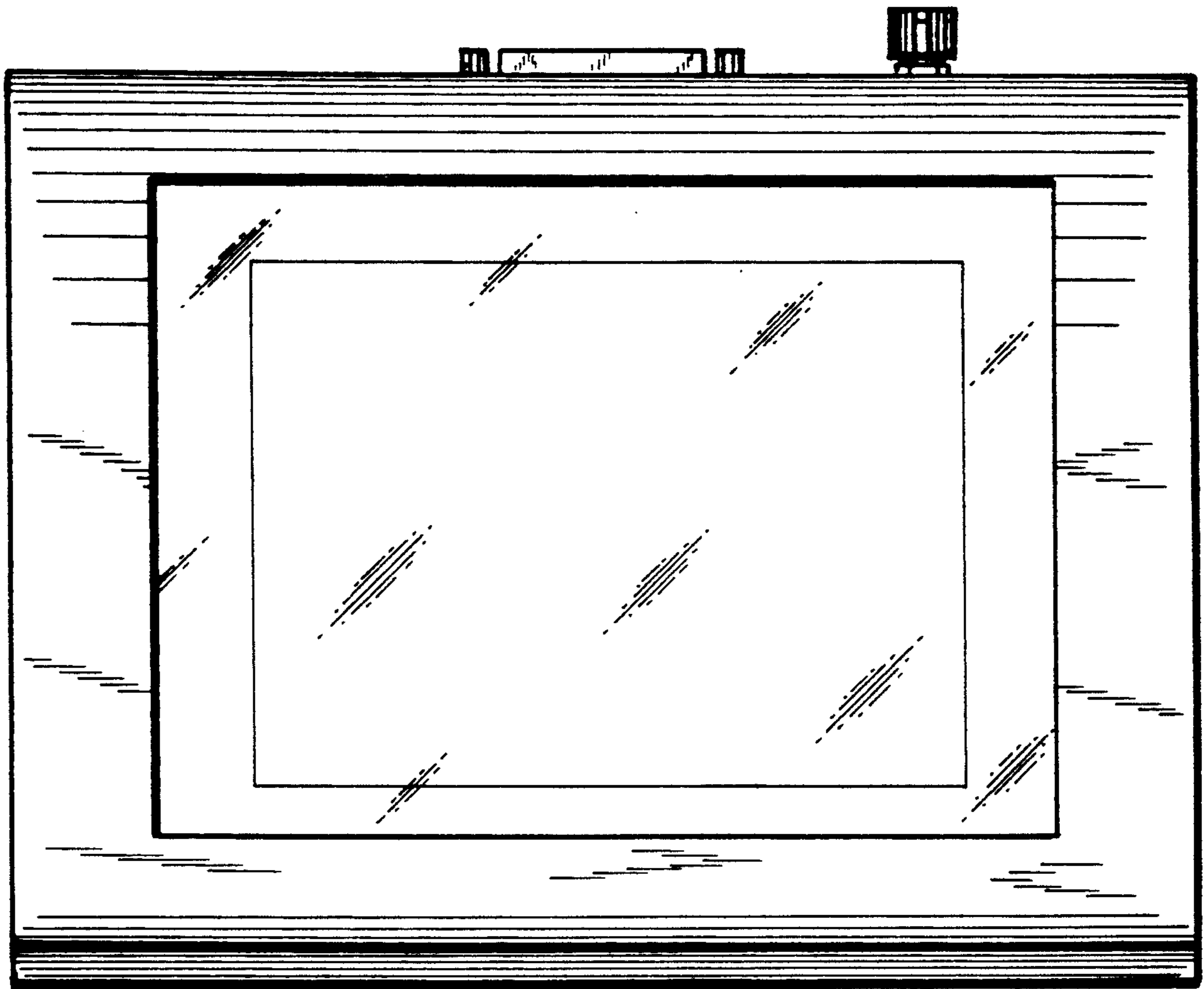

FIG.3

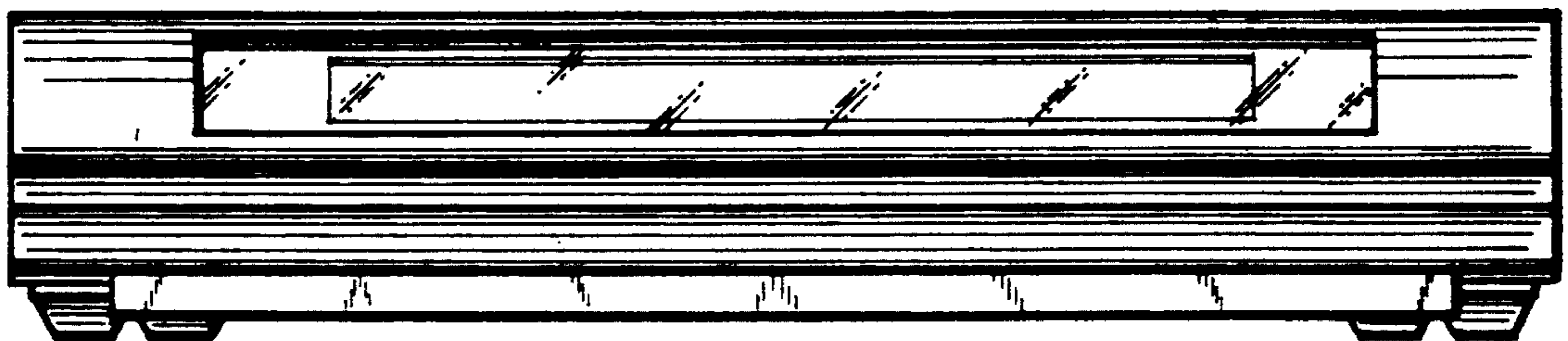

FIG.4

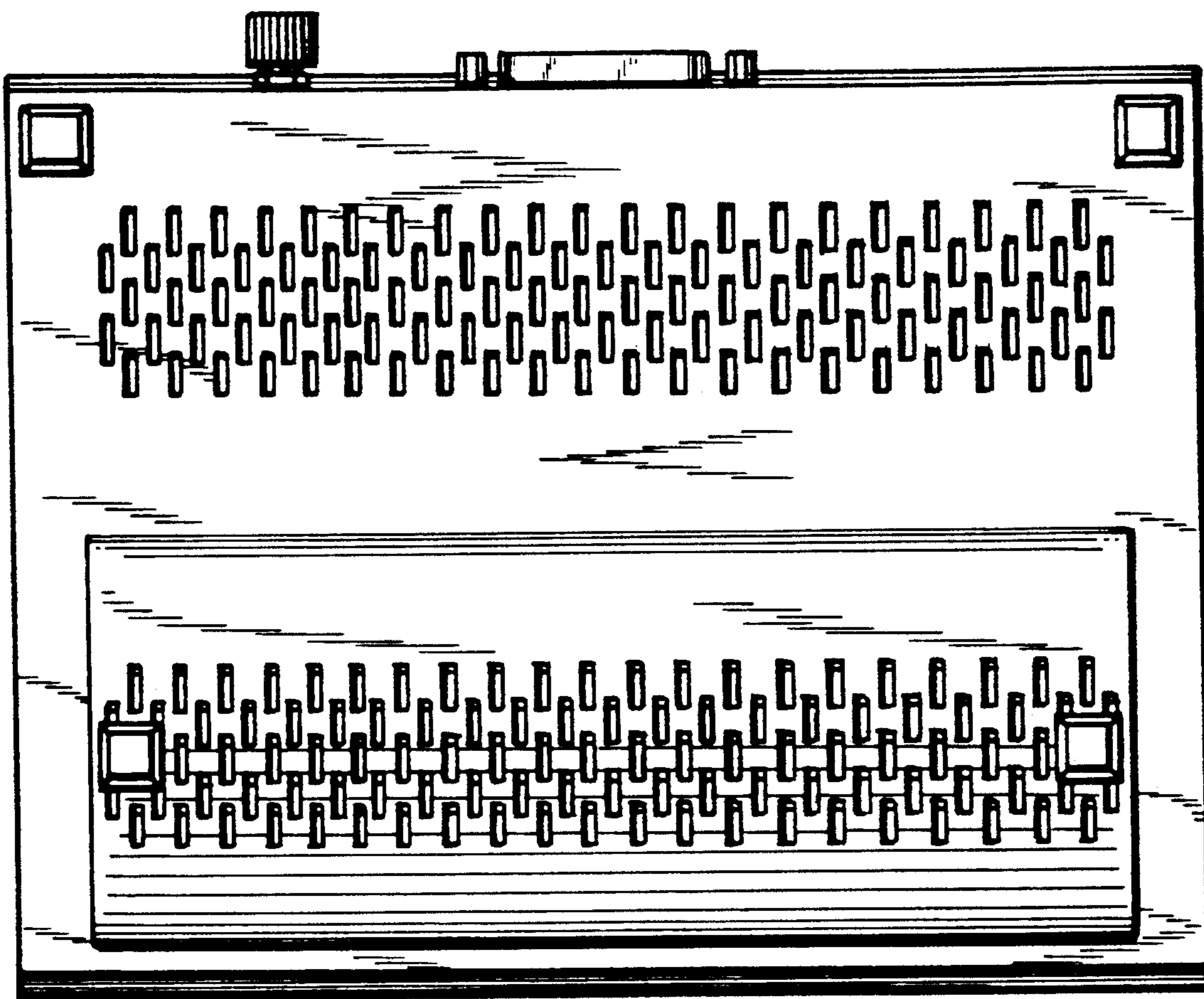

FIG. 5

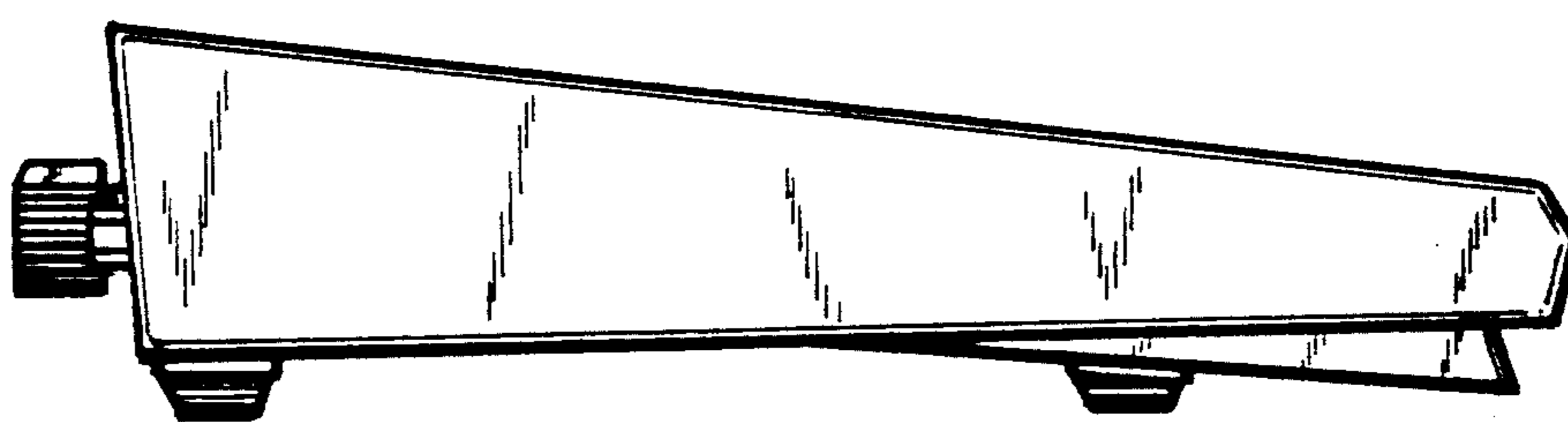

FIG. 6

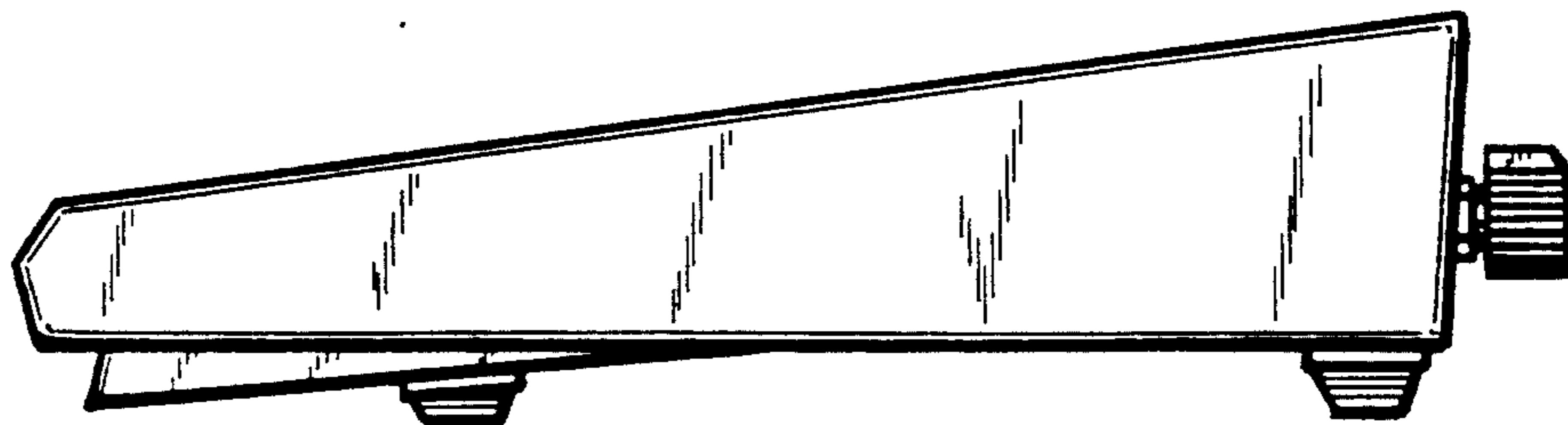

FIG. 7

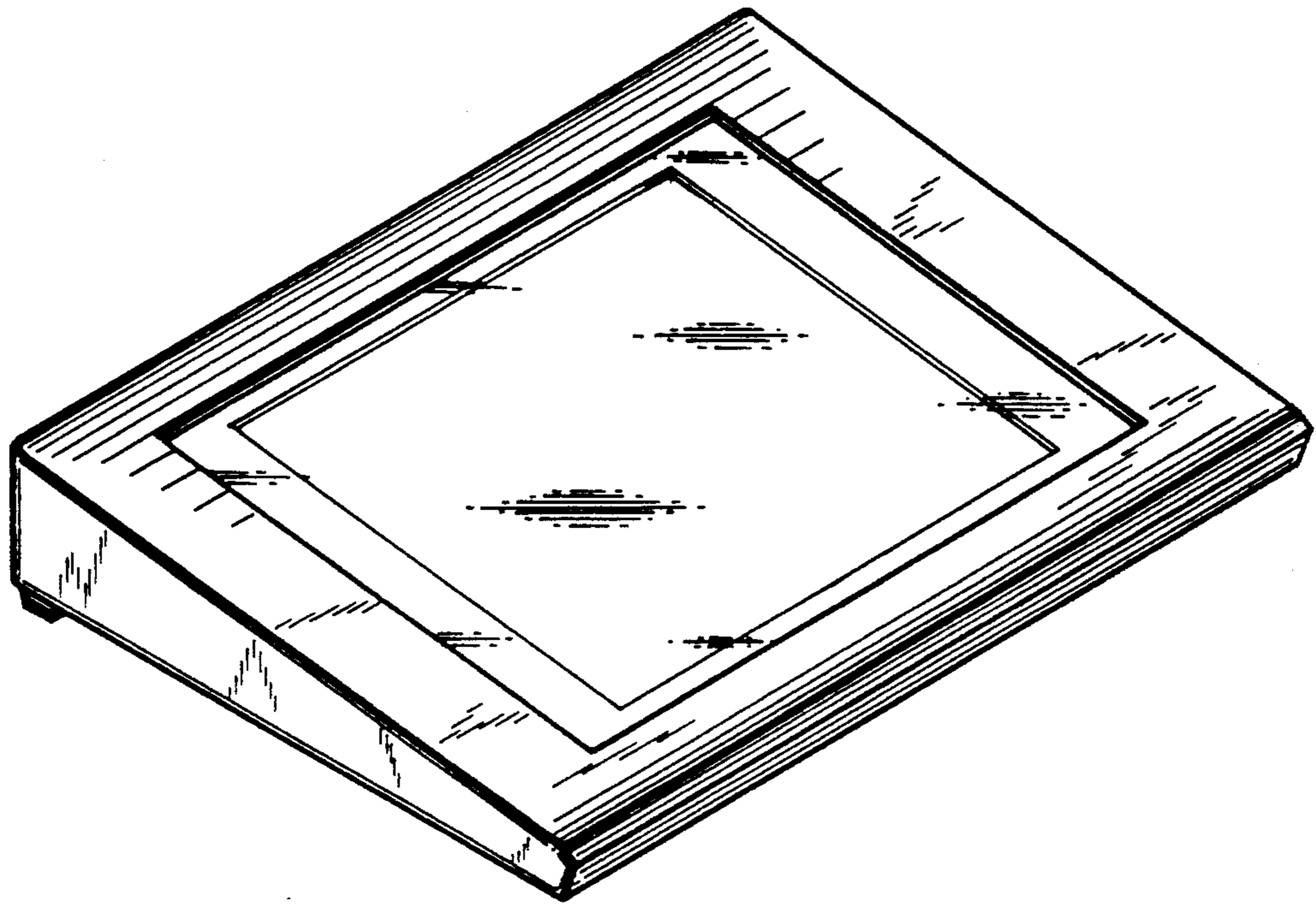

FIG. 8

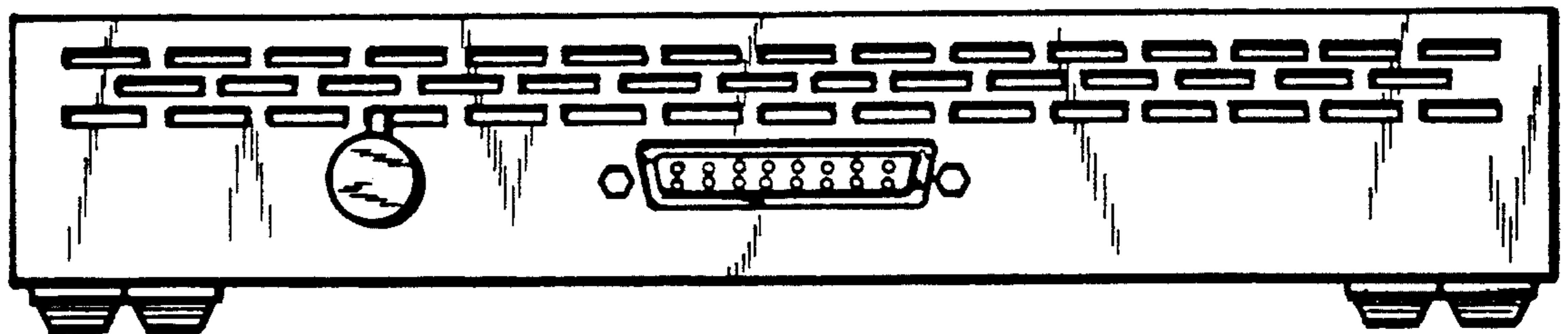

FIG. 9

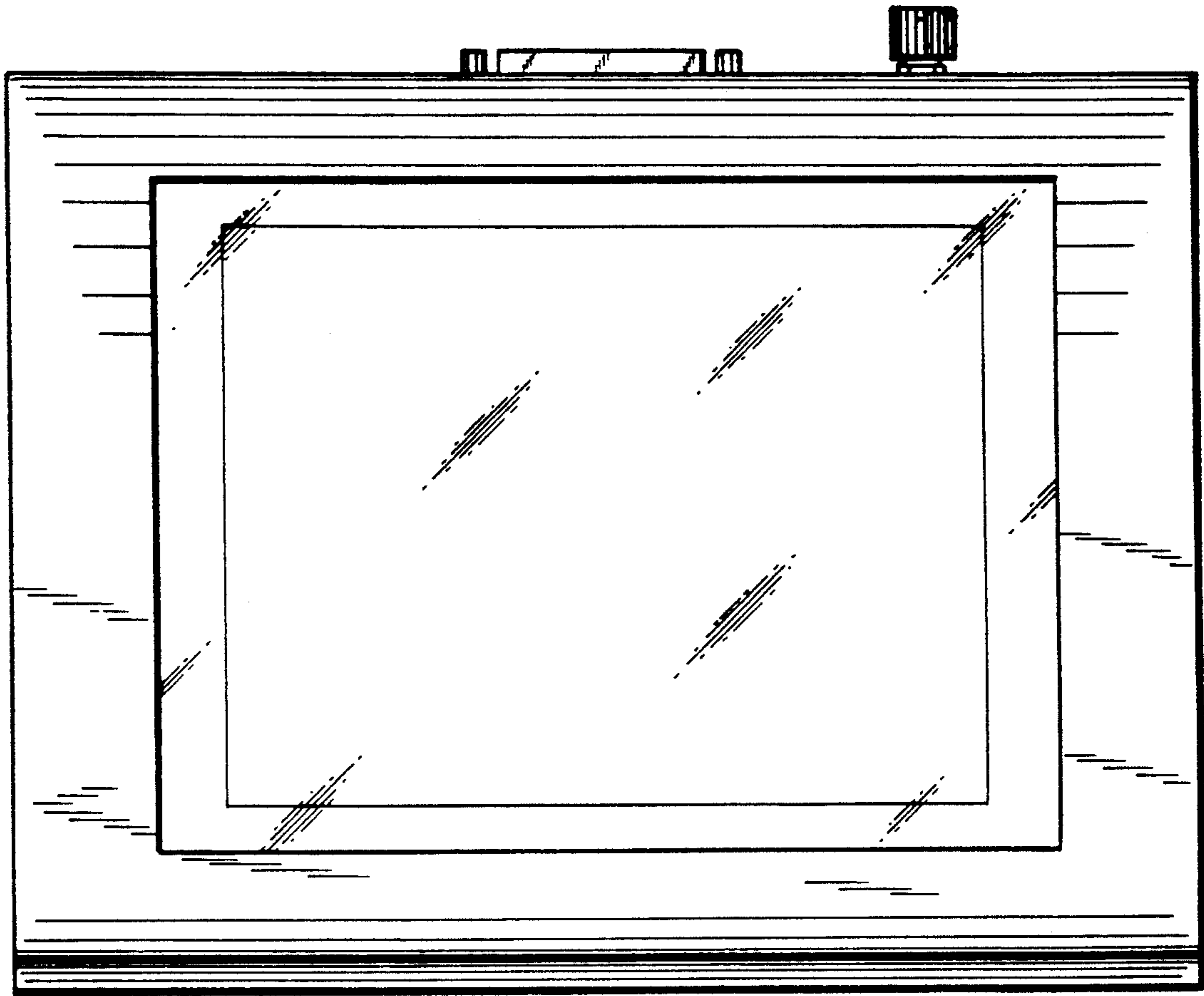

FIG.10

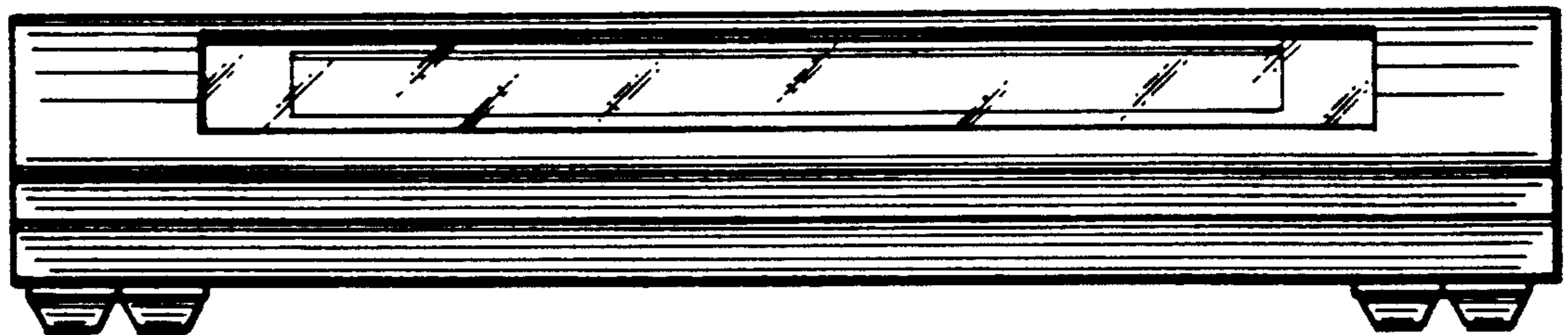

FIG.11

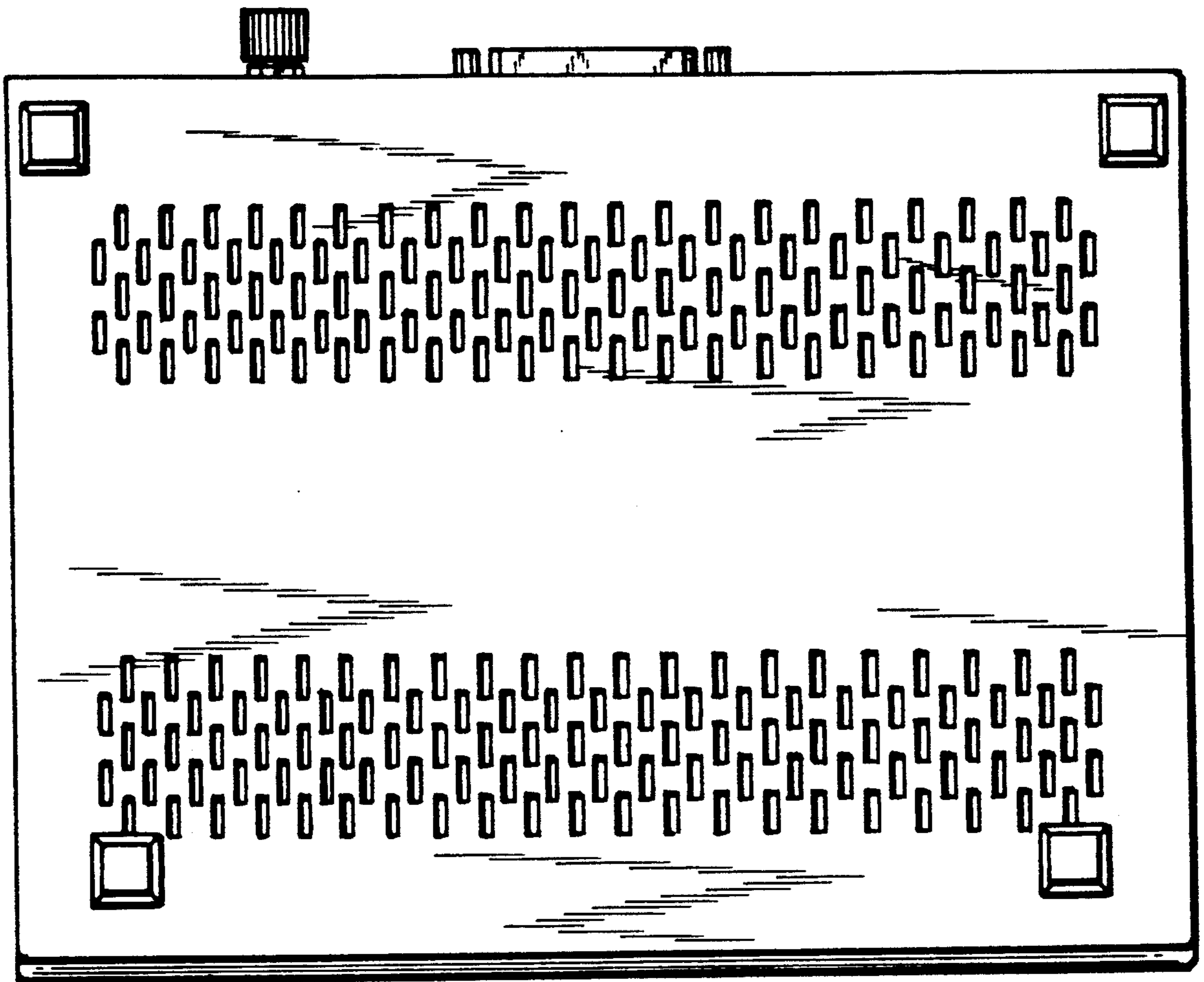

FIG. 12

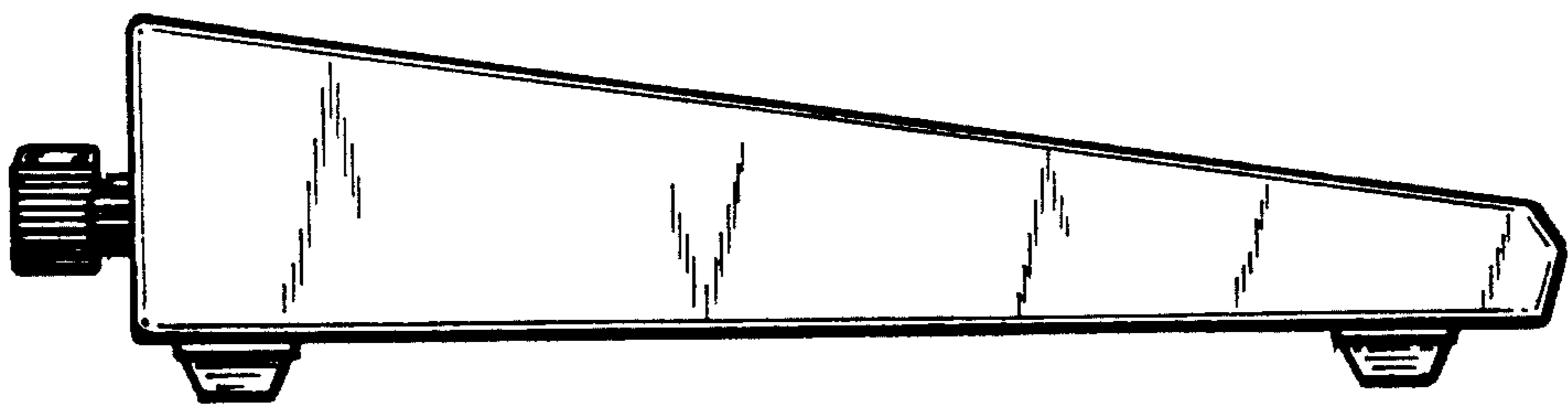

FIG. 13

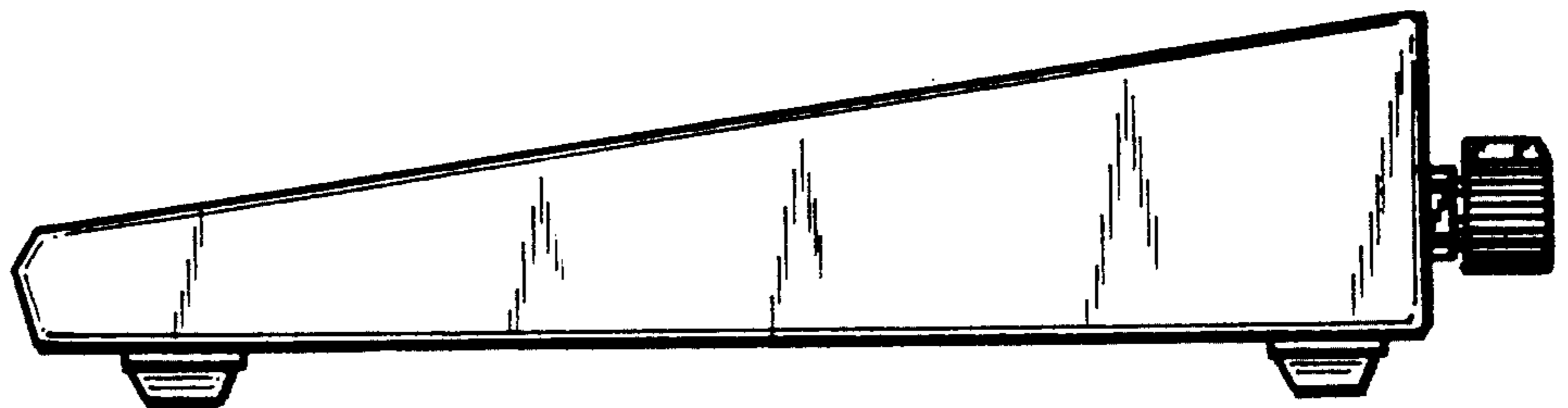

FIG. 14