



US00D348609S

United States Patent [19]

[11] Patent Number: Des. 348,609

Eisman et al.

[45] Date of Patent: ** Jul. 12, 1994

[54] **FOOD CARTON WITH HINGED COVER**

[75] Inventors: **Larry Eisman**, Elkins Park; **Joel B. Corder**, Pottstown, both of Pa.

[73] Assignee: **Dopaco, Inc.**, Downingtown, Pa.

[**] Term: **14 Years**

[21] Appl. No.: **2,267**

[22] Filed: **Dec. 7, 1992**

[52] U.S. Cl. **D9/430; D9/423**

[58] Field of Search **D9/430, 431, 433, 346, D9/423-426; 229/110, 109, 112, 113, 114, 148, 150, 178, 901, 902, 906, 125.27, 125.29; 206/45.32, 551, 507; 220/23.4**

[56] **References Cited**

U.S. PATENT DOCUMENTS

D. 329,806	9/1992	Kindt	D9/430
D. 340,411	10/1993	Ong	D9/433
2,028,677	1/1936	Lupton .	
2,307,076	1/1943	Ray .	
2,499,780	3/1950	Rottman .	
2,819,833	1/1958	Sauer .	
2,925,213	2/1960	Zukoski	229/109 X
4,809,908	3/1989	Keefe et al.	229/150
4,856,707	8/1989	Lorenz	229/114
4,877,178	10/1989	Eisman	229/114
4,930,681	6/1990	Fultz et al.	229/906 X
5,039,003	8/1991	Gordon et al. .	
5,110,039	5/1992	Philips .	
5,118,032	6/1992	Geho	229/110
5,188,284	2/1993	Eisman	229/125.27 X
5,226,587	7/1993	Eisman et al.	229/110
5,249,736	10/1993	Eisman	229/110

Primary Examiner—Prabhakar G. Deshmukh

Attorney, Agent, or Firm—Dennison, Meserole, Pollack & Scheiner

[57] **CLAIM**

The ornamental design for a food carton with hinged cover, as shown and described.

DESCRIPTION

FIG. 1 is a top front perspective view of a food carton with hinged cover showing my new design;
 FIG. 2 is a bottom rear perspective view thereof;
 FIG. 3 is a top plan view thereof;
 FIG. 4 is a bottom plan view thereof;
 FIG. 5 is a front elevation view thereof;
 FIG. 6 is an elevation view thereof rotated 60° left from the front elevation, the view rotated 60° right is a mirror image thereof;
 FIG. 7 is an elevation view thereof rotated 120° left from the front elevation, the view rotated 120° right is a mirror image thereof;
 FIG. 8 is a rear elevation view thereof;
 FIG. 9 is a top perspective view with the cover open;
 FIG. 10 is top front perspective view of a second embodiment of FIG. 1;
 FIG. 11 is a bottom perspective view of FIG. 10;
 FIG. 12 is a front elevation view of FIG. 10;
 FIG. 13 is an elevation view of FIG. 10 rotated 60° left from the front elevation, the view rotated 60° right is a mirror image thereof;
 FIG. 14 is an elevation view of FIG. 10 rotated 120° left from the front elevation; the view rotated 120° right is a mirror image thereof;
 FIG. 15 is a rear elevation of FIG. 10; and,
 FIG. 16 is top perspective view of FIG. 10 with the cover open.

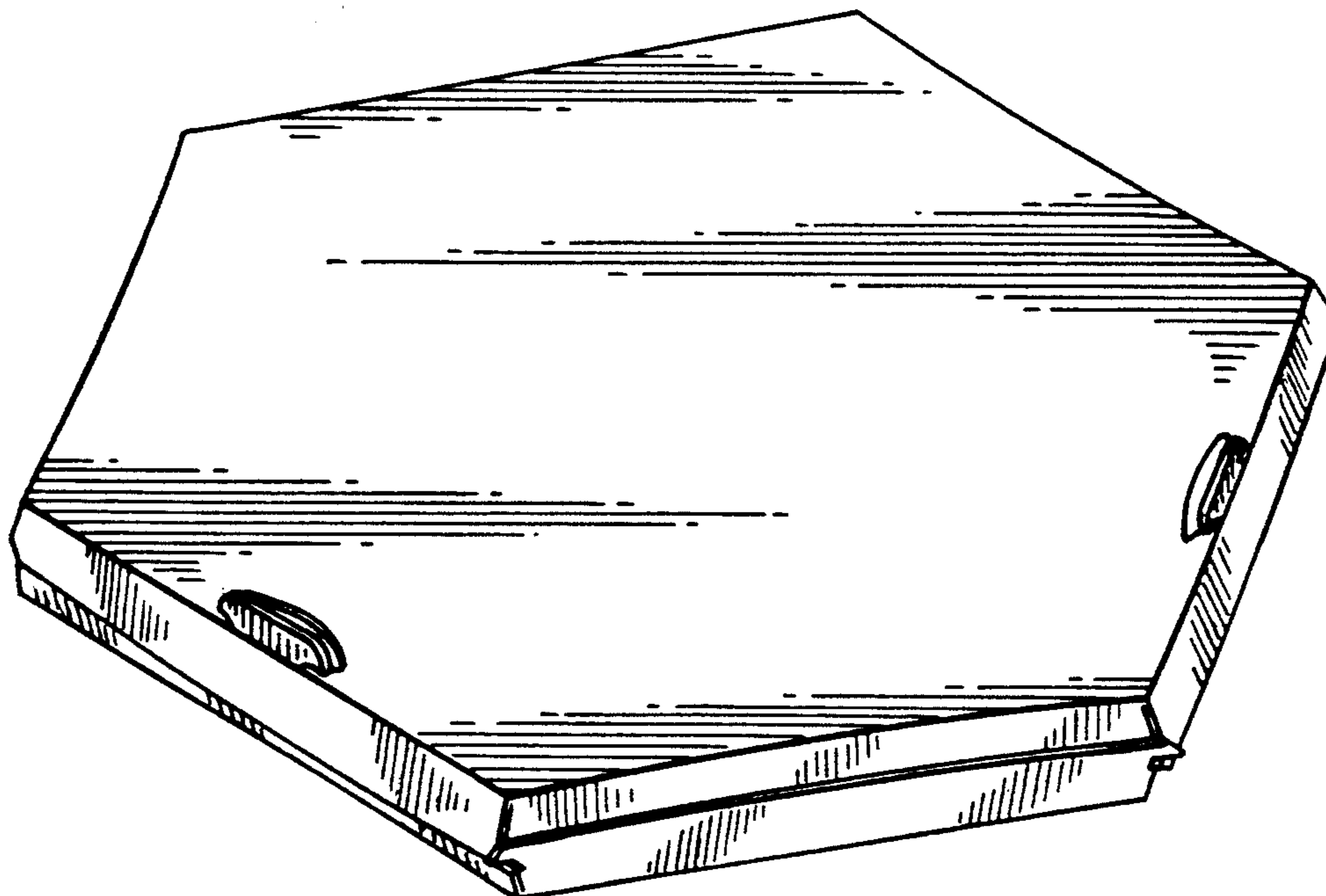

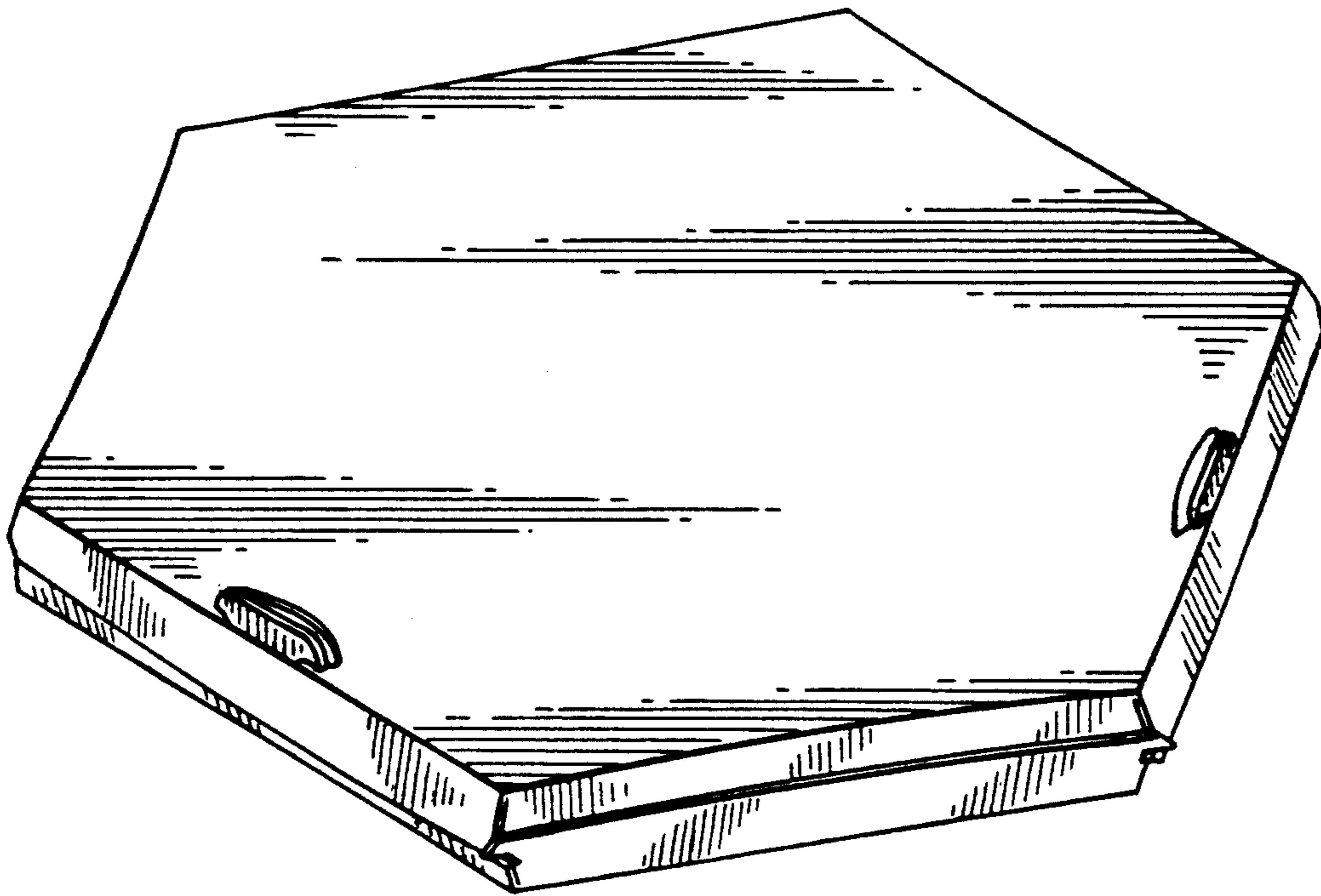
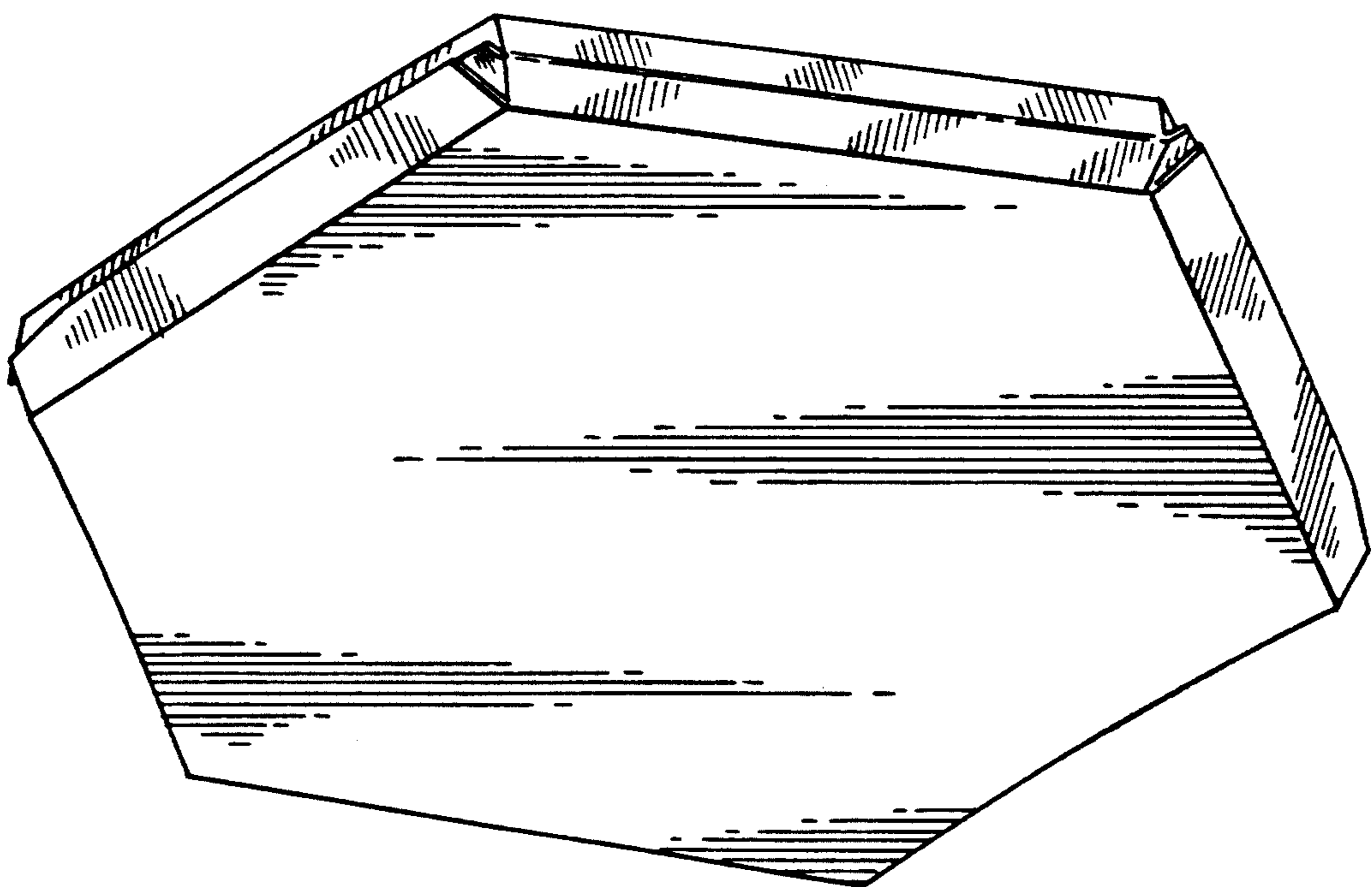
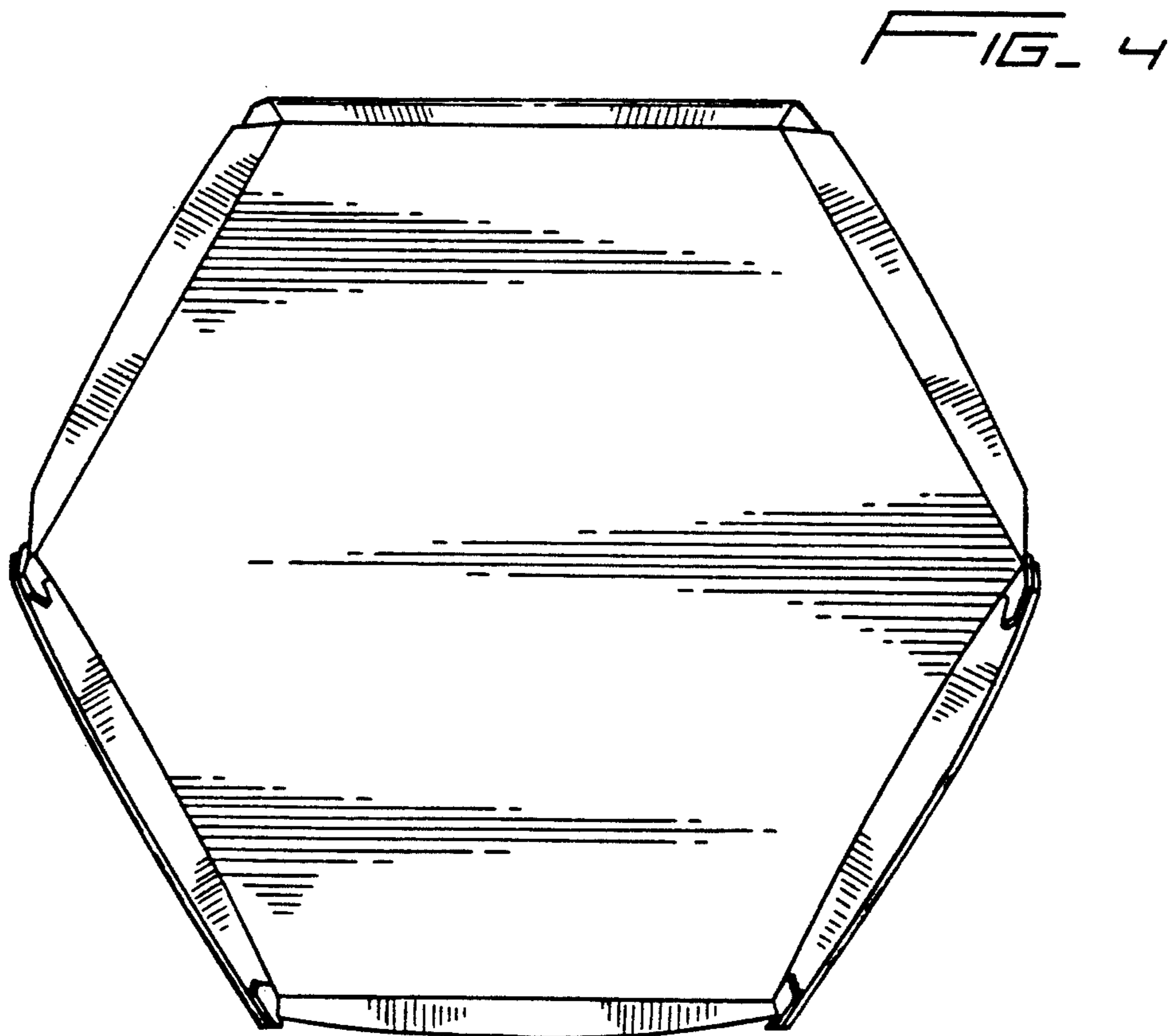
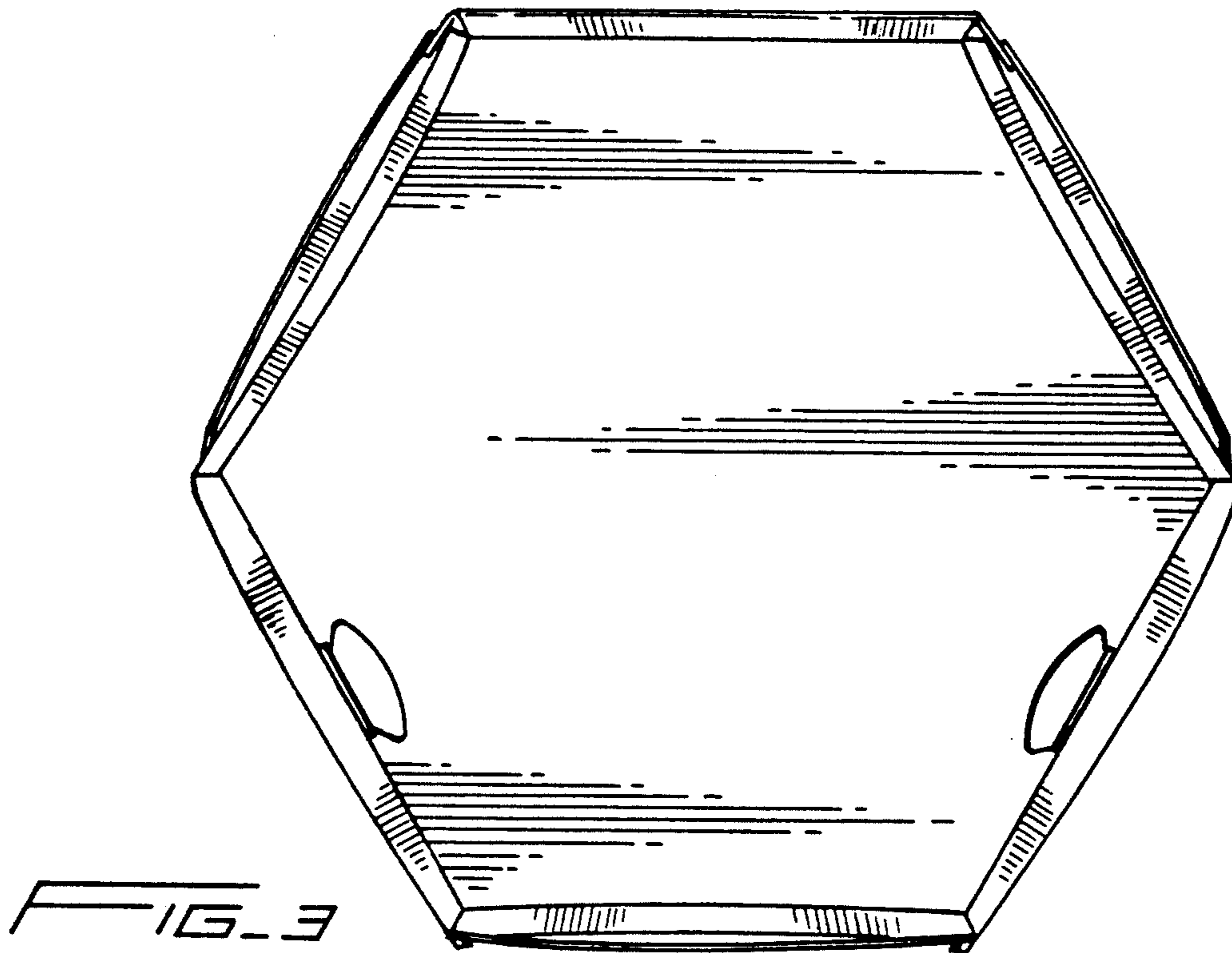

FIG. 1

FIG. 2





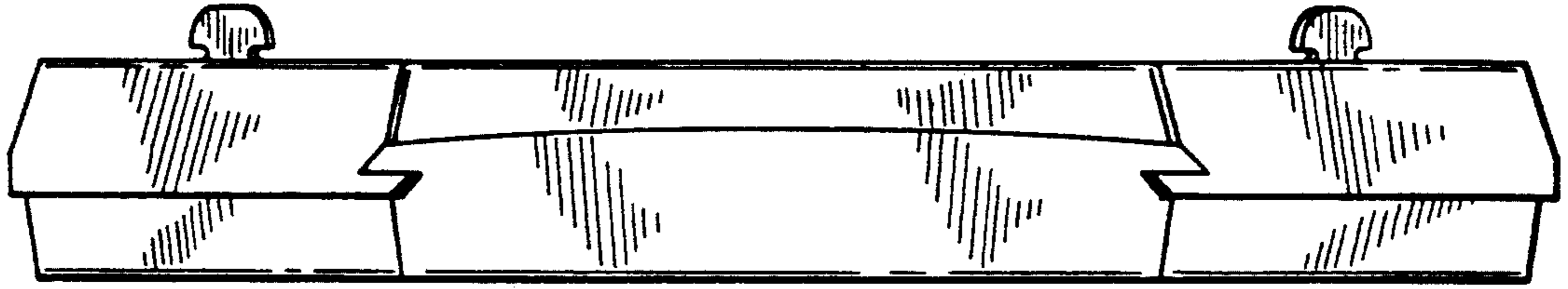

FIG. 5

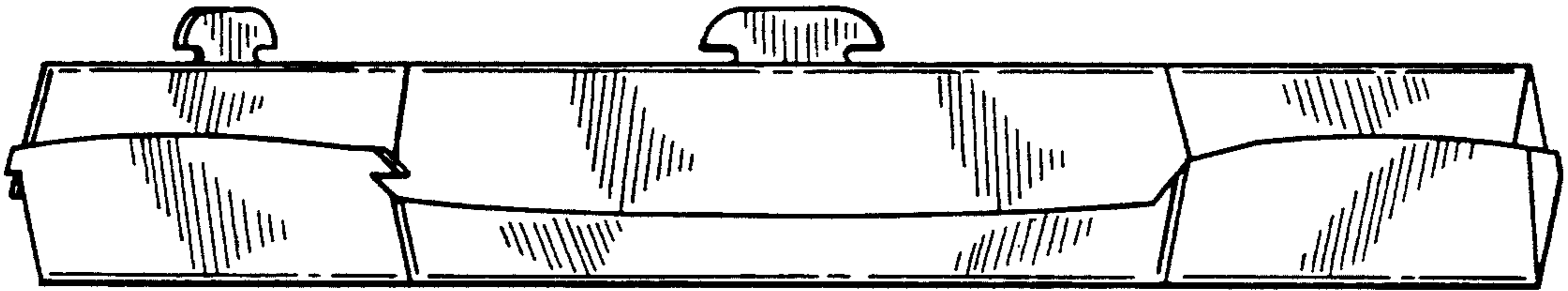

FIG. 6

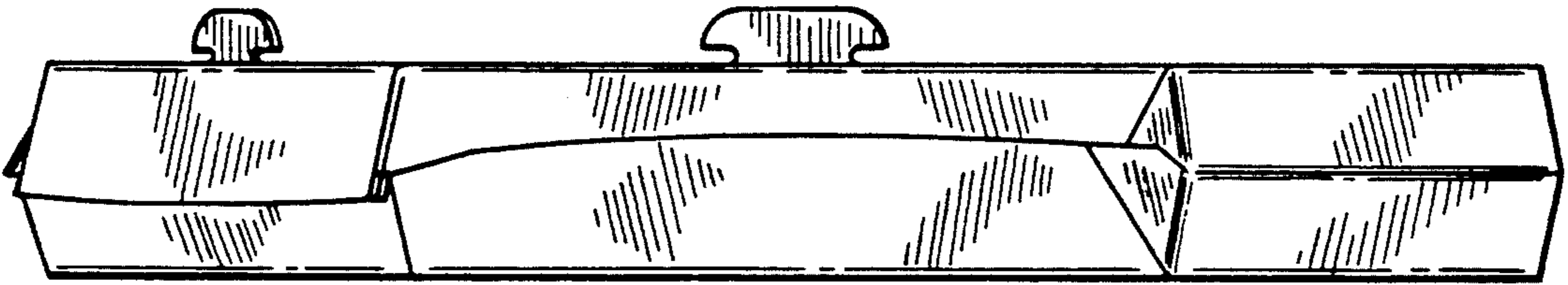

FIG. 7

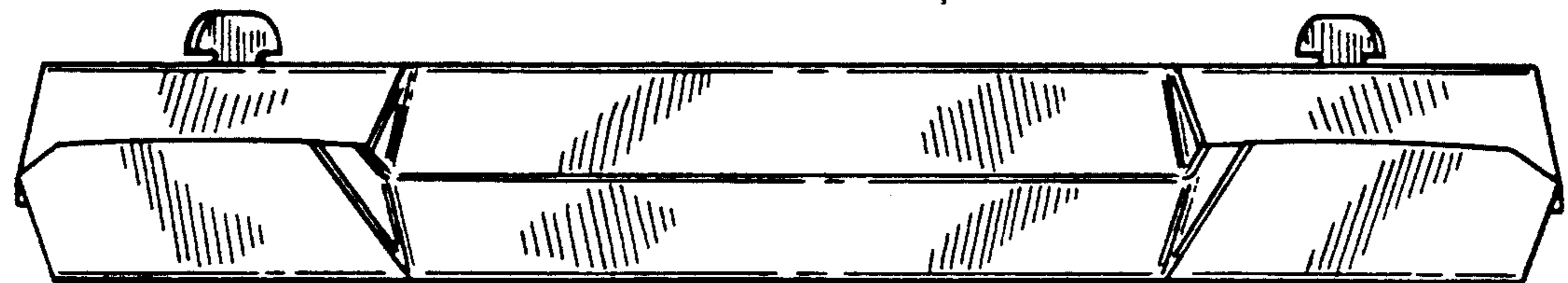

FIG. 8

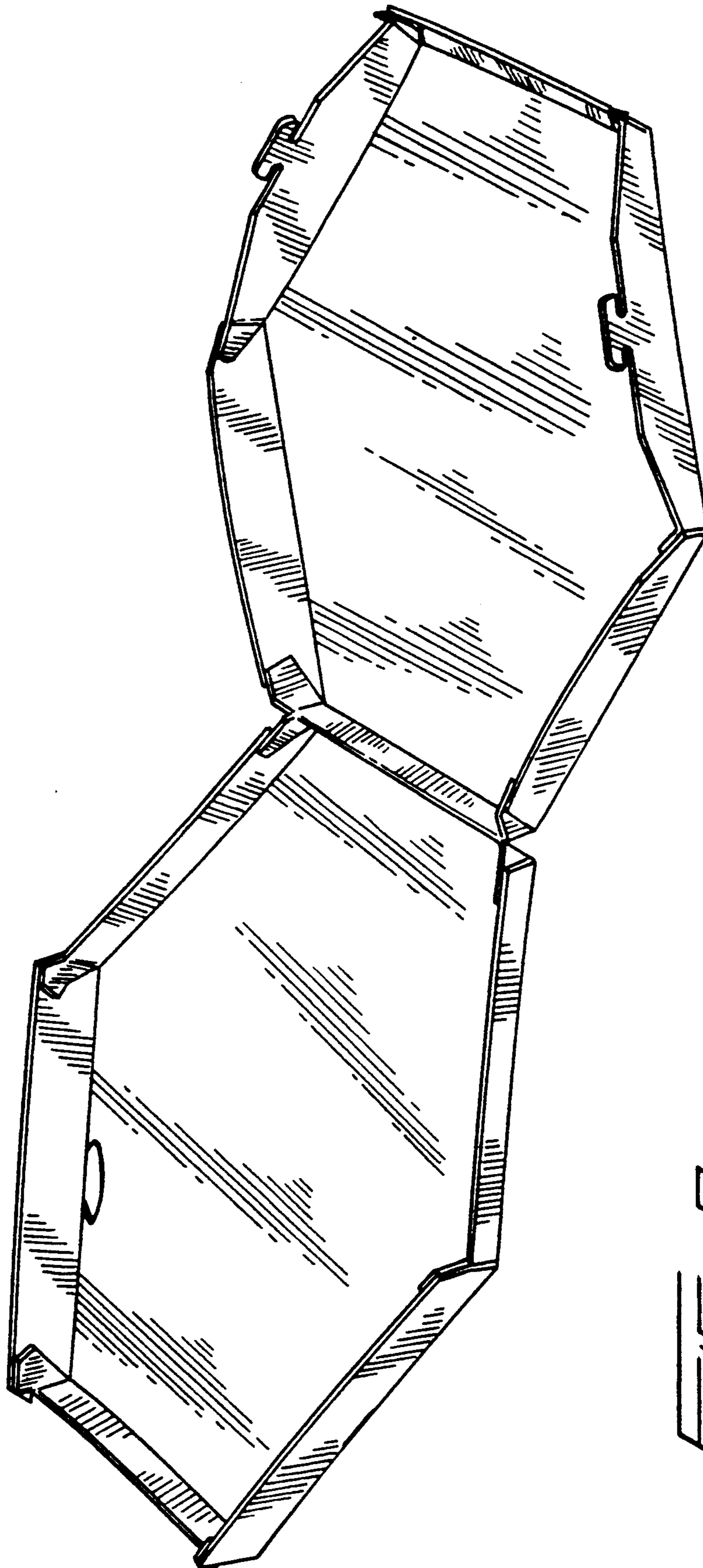

FIG. 9

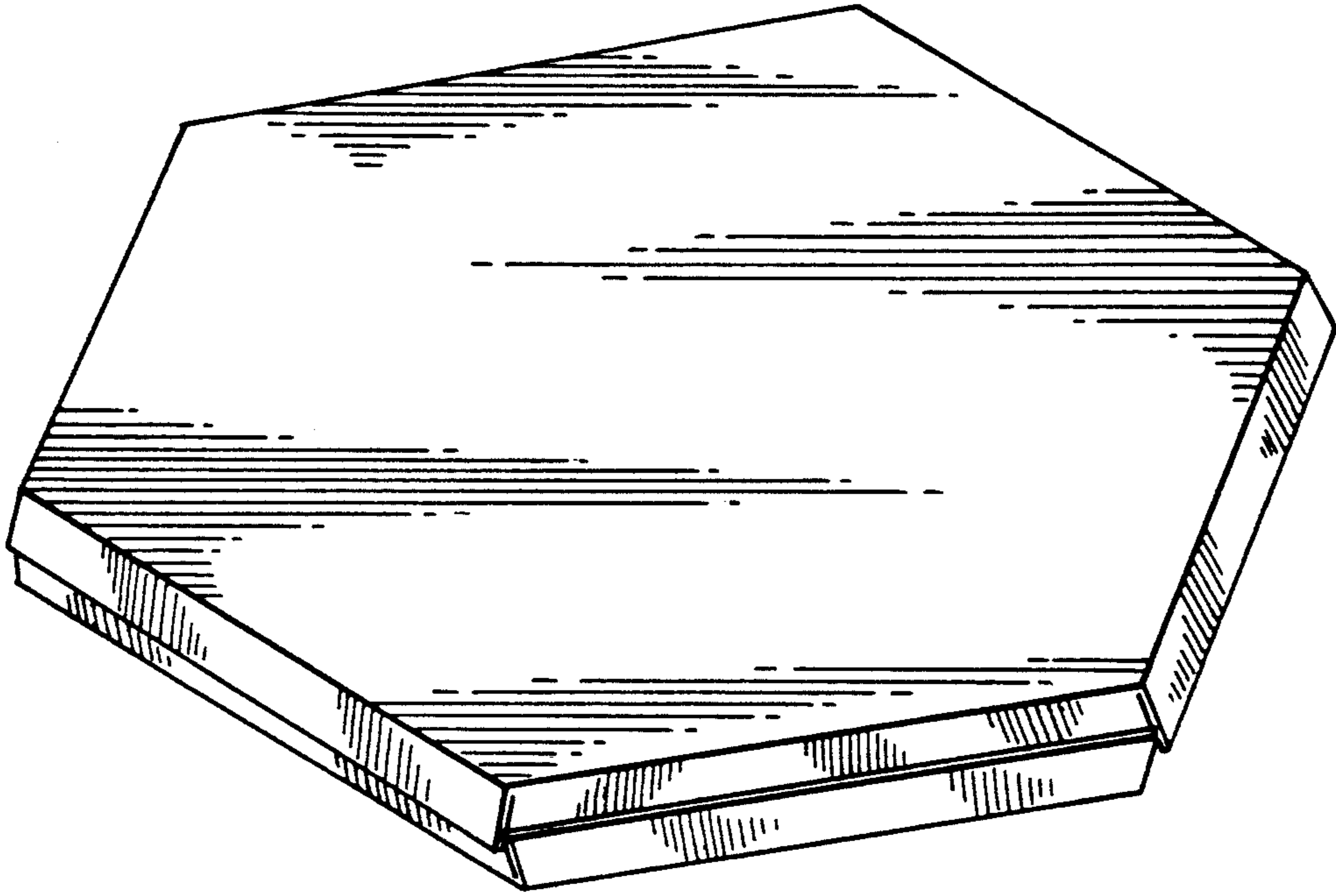
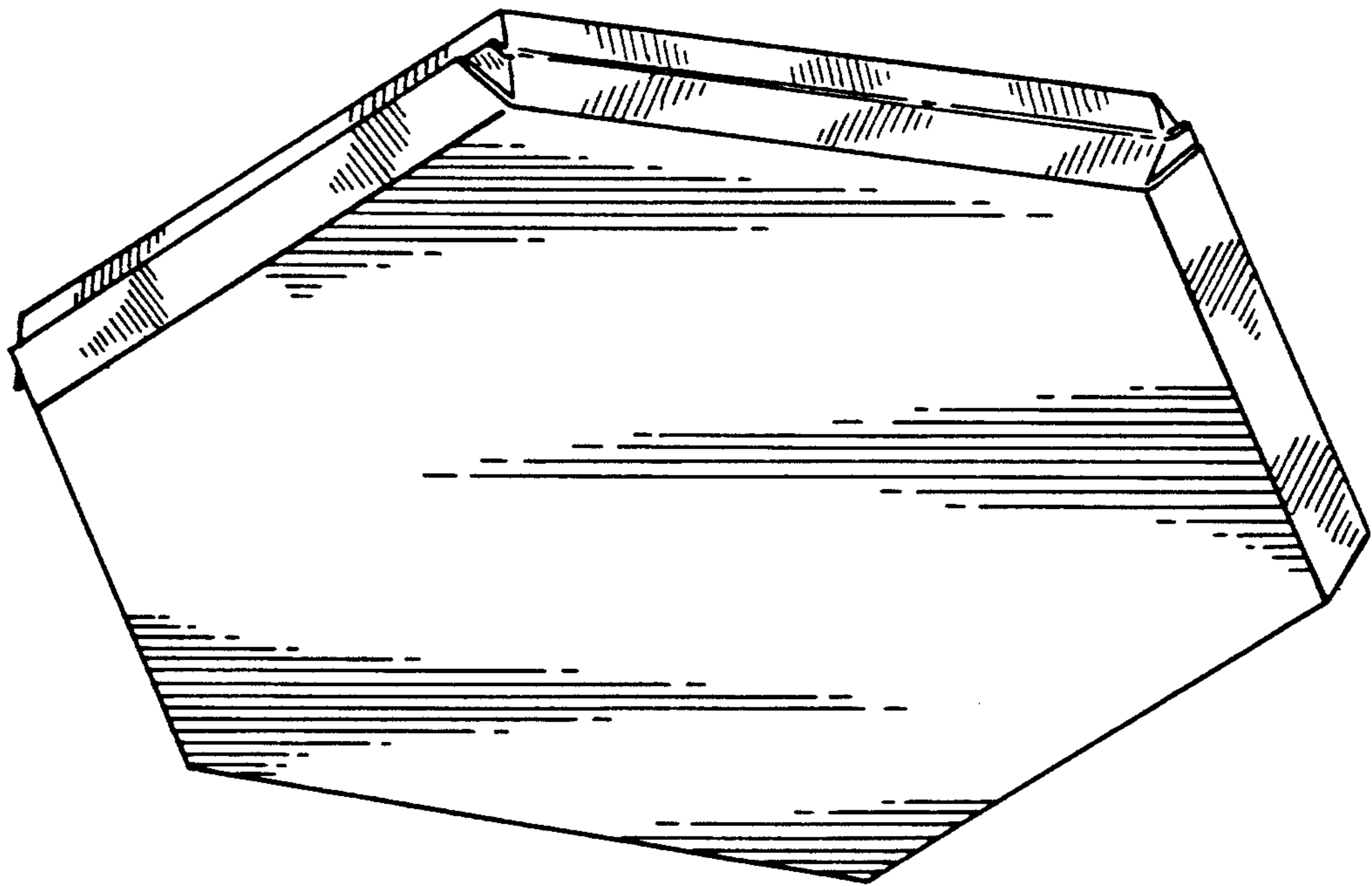

FIG. 10

FIG. 11



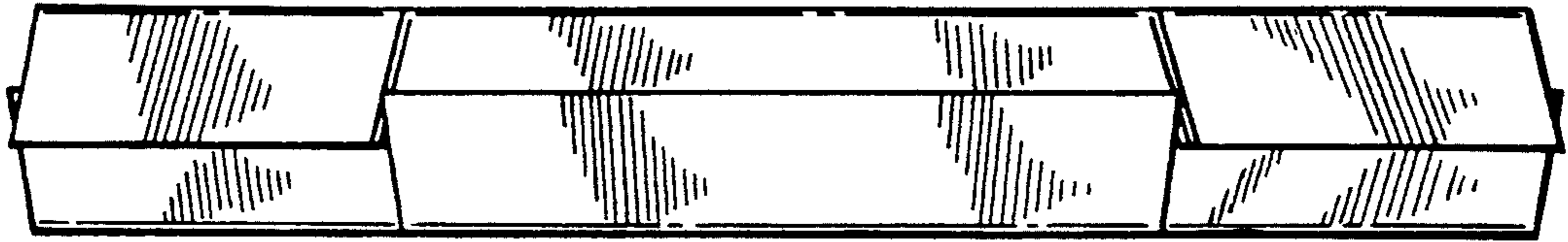

FIG. 12

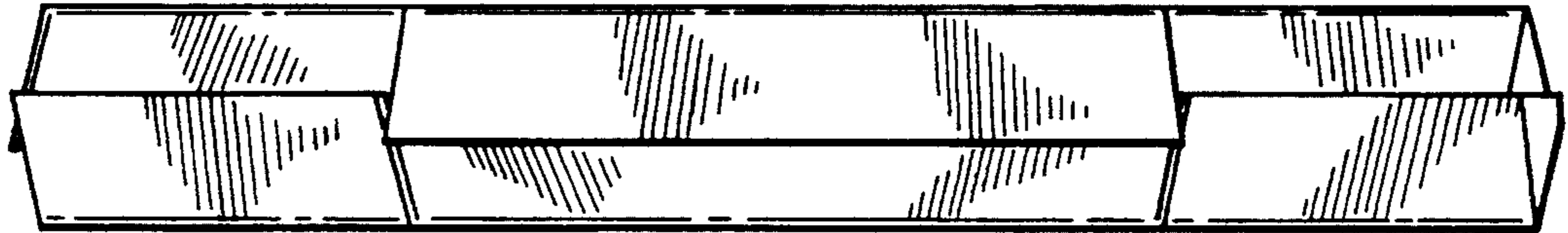

FIG. 13



FIG. 14

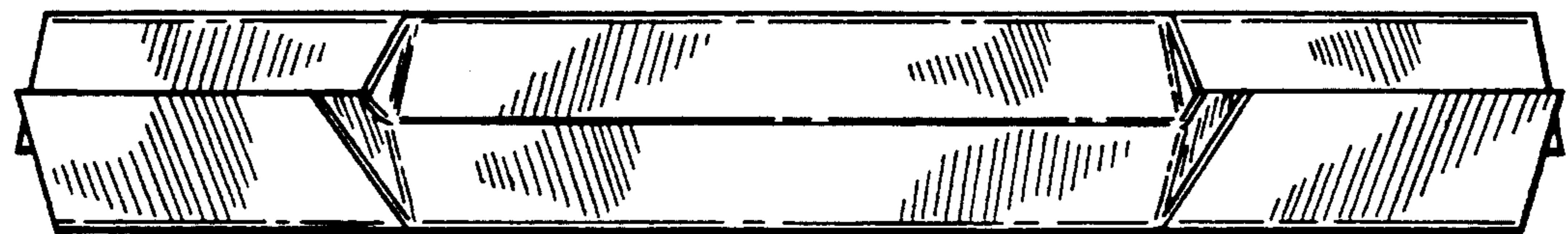

FIG. 15

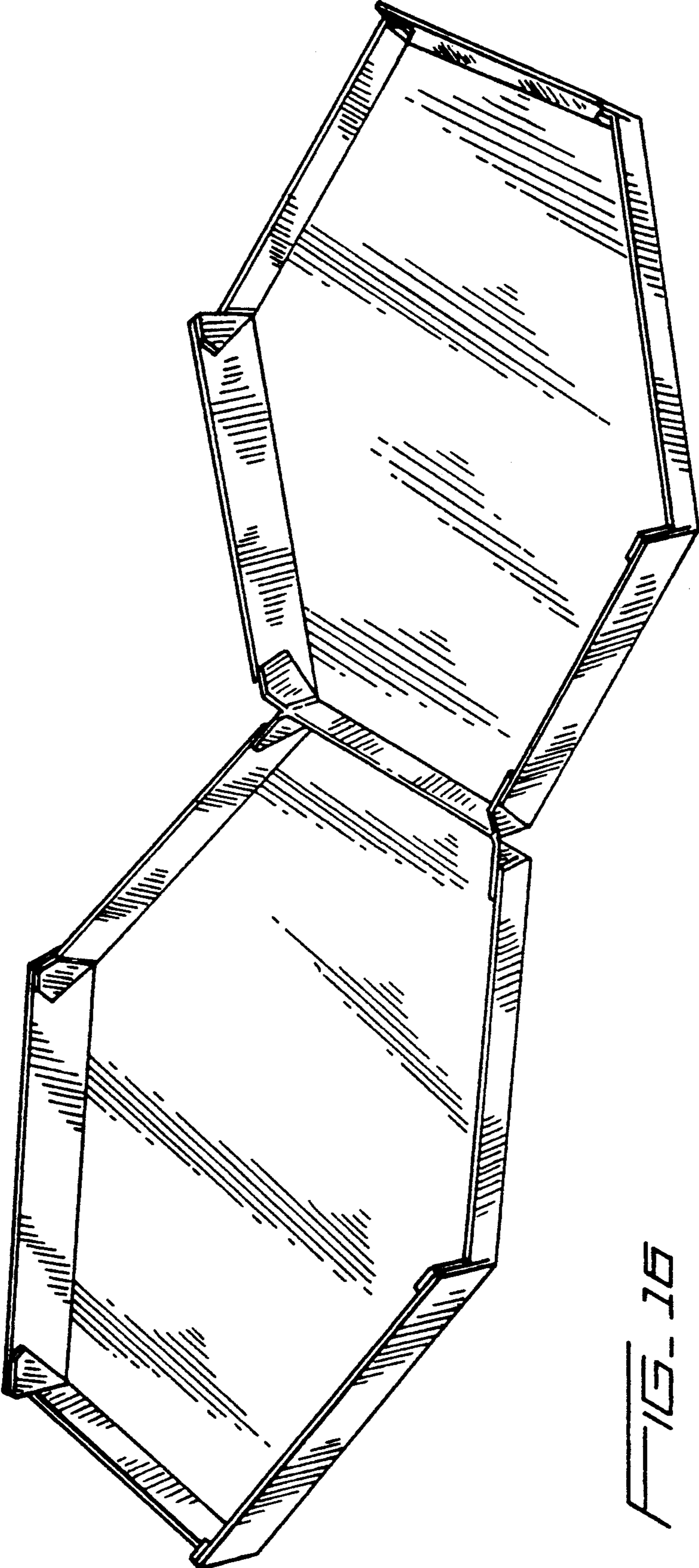

FIG. 16