



US00D348584S

United States Patent [19]

[11] Patent Number: **Des. 348,584**

Sankey

[45] Date of Patent: **** Jul. 12, 1994**

[54] **AUDIO CASSETTE STORAGE CONTAINER**

[75] Inventor: **James K. Sankey**, Hudson, Ohio

[73] Assignee: **Alpha Enterprises, Inc.**, North Canton, Ohio

[*] Notice: The portion of the term of this patent subsequent to Jun. 21, 2008 has been disclaimed.

[**] Term: **14 Years**

[21] Appl. No.: **927,371**

[22] Filed: **Aug. 10, 1992**

[52] U.S. Cl. **D6/632**

[58] Field of Search **D3/30.1, 35, 74; D6/407; D9/424; 206/387, 425; D19/75, 76**

[56] **References Cited**

U.S. PATENT DOCUMENTS

- D. 246,854 1/1978 Baker D9/341
- D. 280,467 9/1985 Mihojevich D3/35
- D. 289,342 4/1987 Reichow D3/35
- D. 293,279 12/1987 Evans D3/35
- D. 296,153 6/1988 Reichow D3/35
- D. 298,287 11/1988 Stravitz D3/35
- D. 305,409 1/1990 Michaud et al. D9/425

- D. 306,234 2/1990 Ferstl D3/74
- D. 326,357 5/1992 Chow D3/35
- D. 330,120 10/1992 Temple et al. D6/407
- D. 330,975 11/1992 Stafford D3/35
- 4,629,066 12/1986 Howard 206/425

Primary Examiner—A. Hugo Word
Assistant Examiner—Celia A. Murphy
Attorney, Agent, or Firm—Michael Sand Co.

[57] **CLAIM**

The ornamental design for an audio cassette storage container, as shown and described.

DESCRIPTION

FIG. 1 is a perspective view of an audio cassette storage container shown in a partially open position; FIG. 2 is a front elevational view thereof shown in a closed position; FIG. 3 is a rear elevational view of FIG. 2; FIG. 4 is a top plan view of FIG. 2; FIG. 5 is a bottom plan view of FIG. 2; FIG. 6 is a top plan view thereof, shown in a fully open position; FIG. 7 is a right side elevational view of FIG. 2, the left side being a mirror image; and, FIG. 8 is a right side elevational view of FIG. 6.

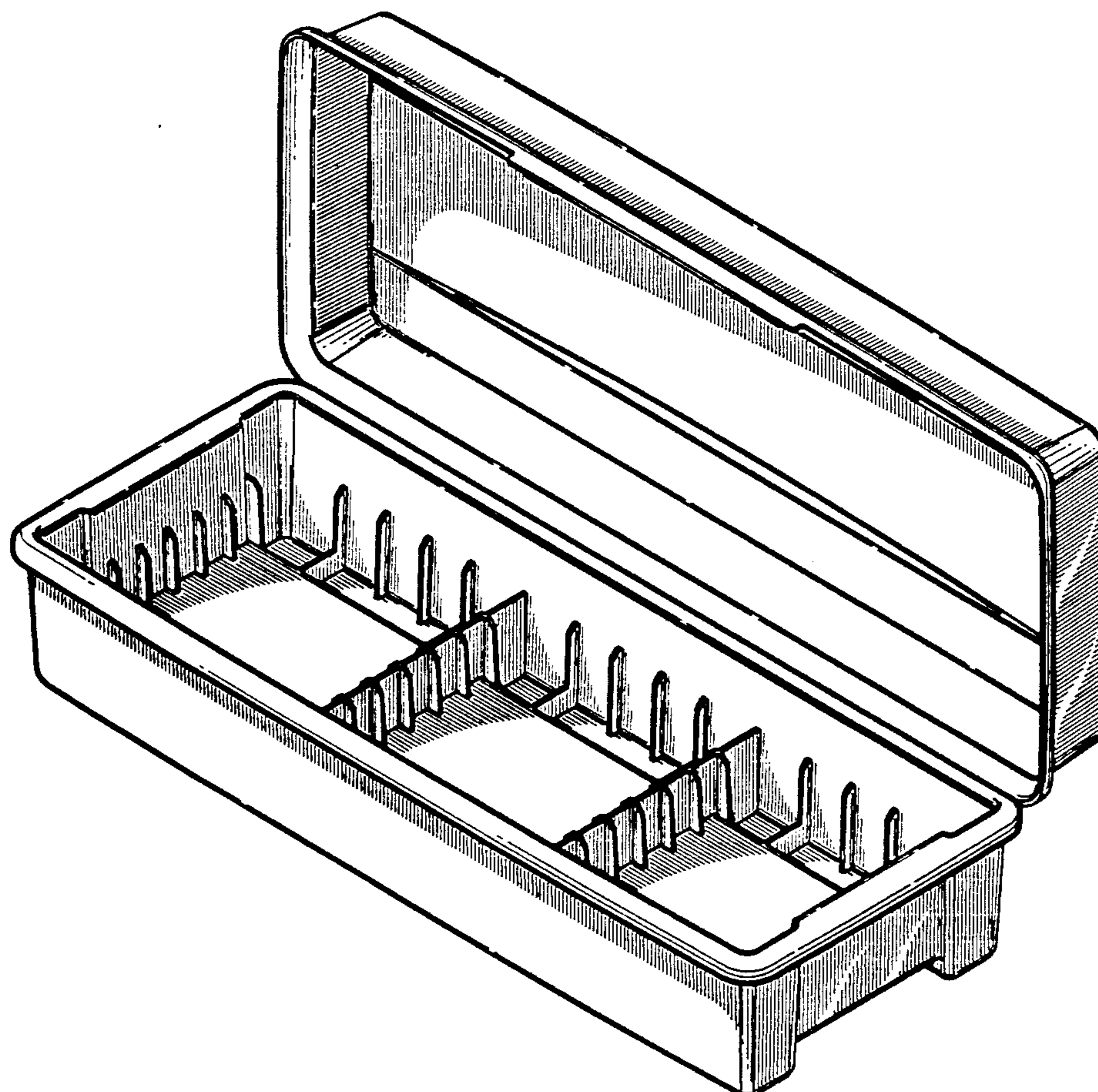

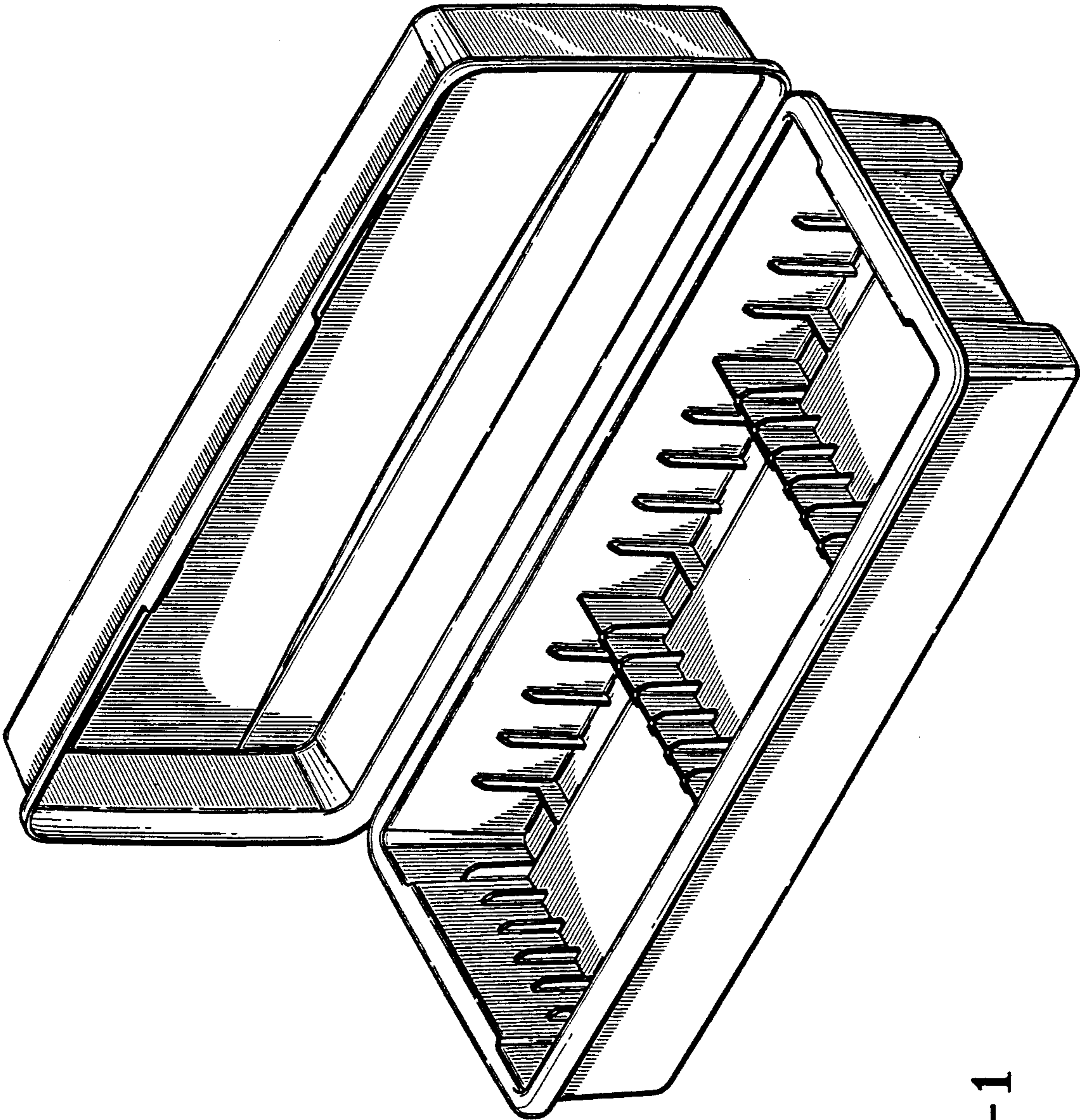

FIG-1

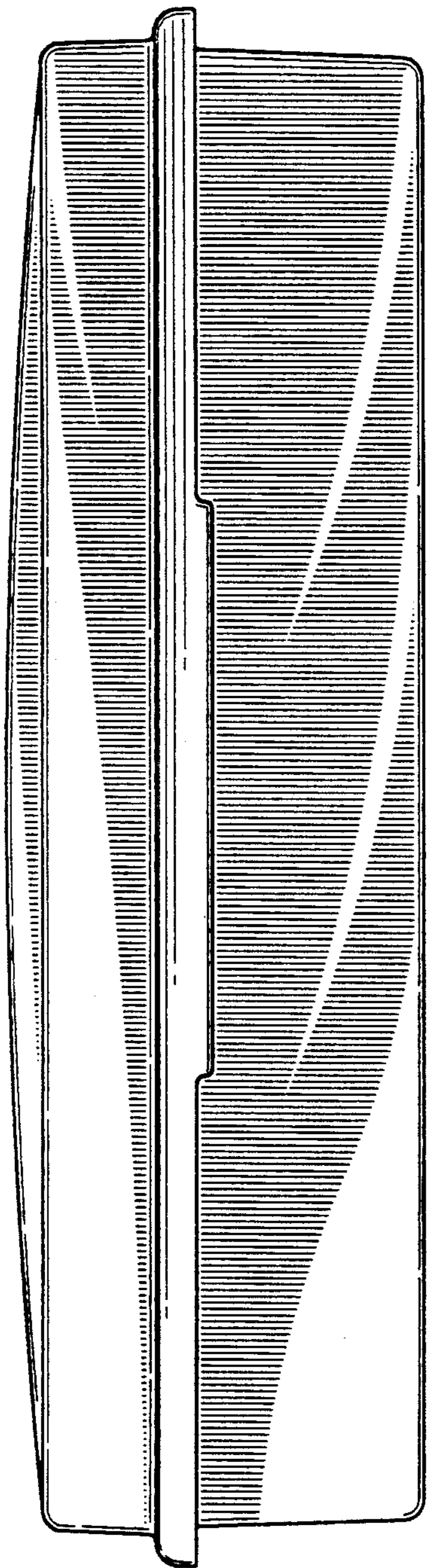

FIG-2

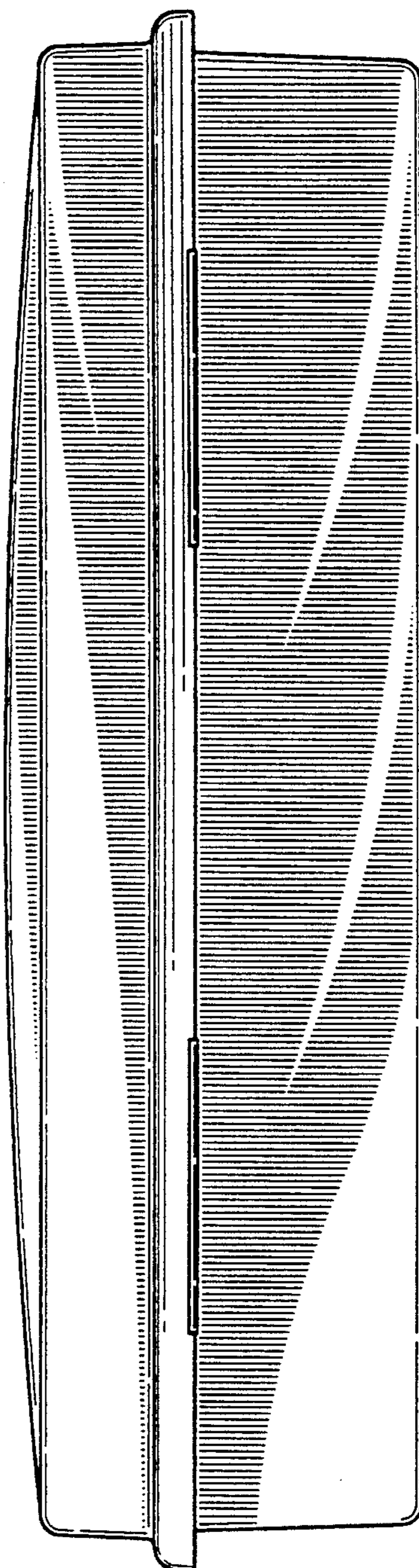

FIG-3

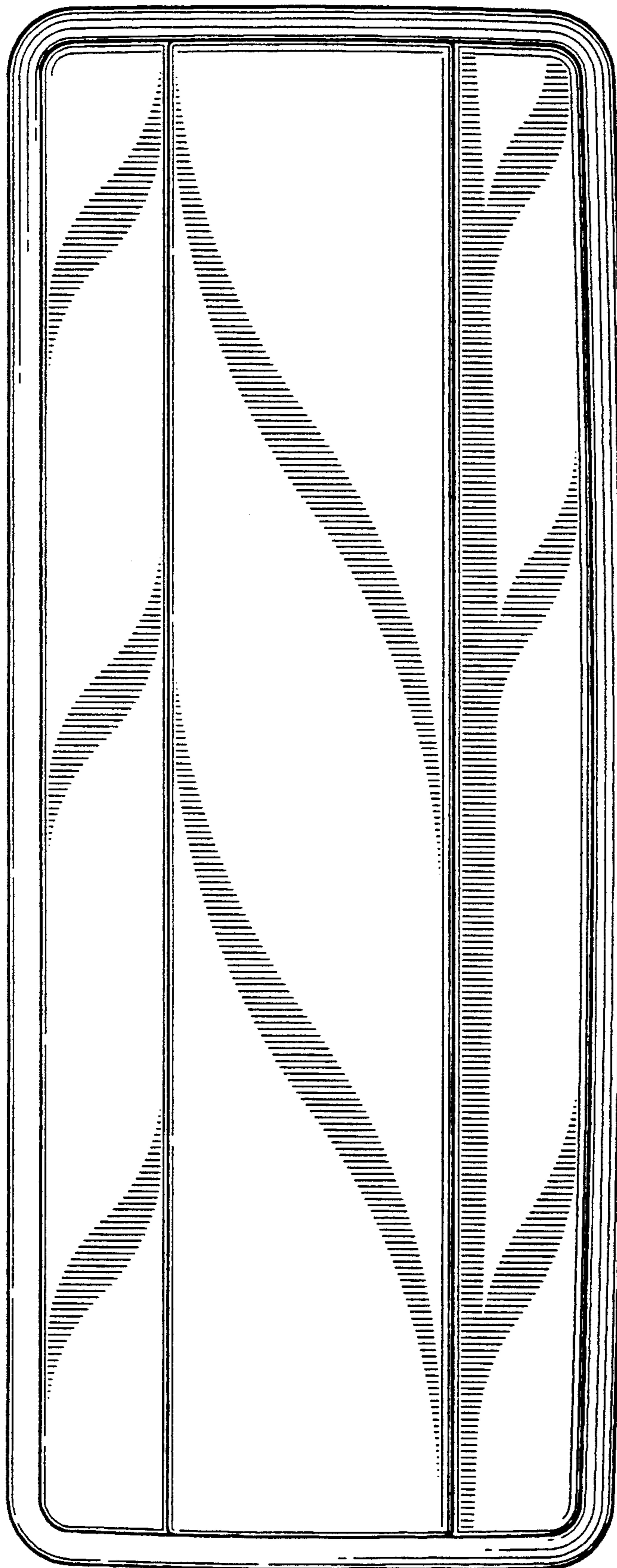

FIG-4

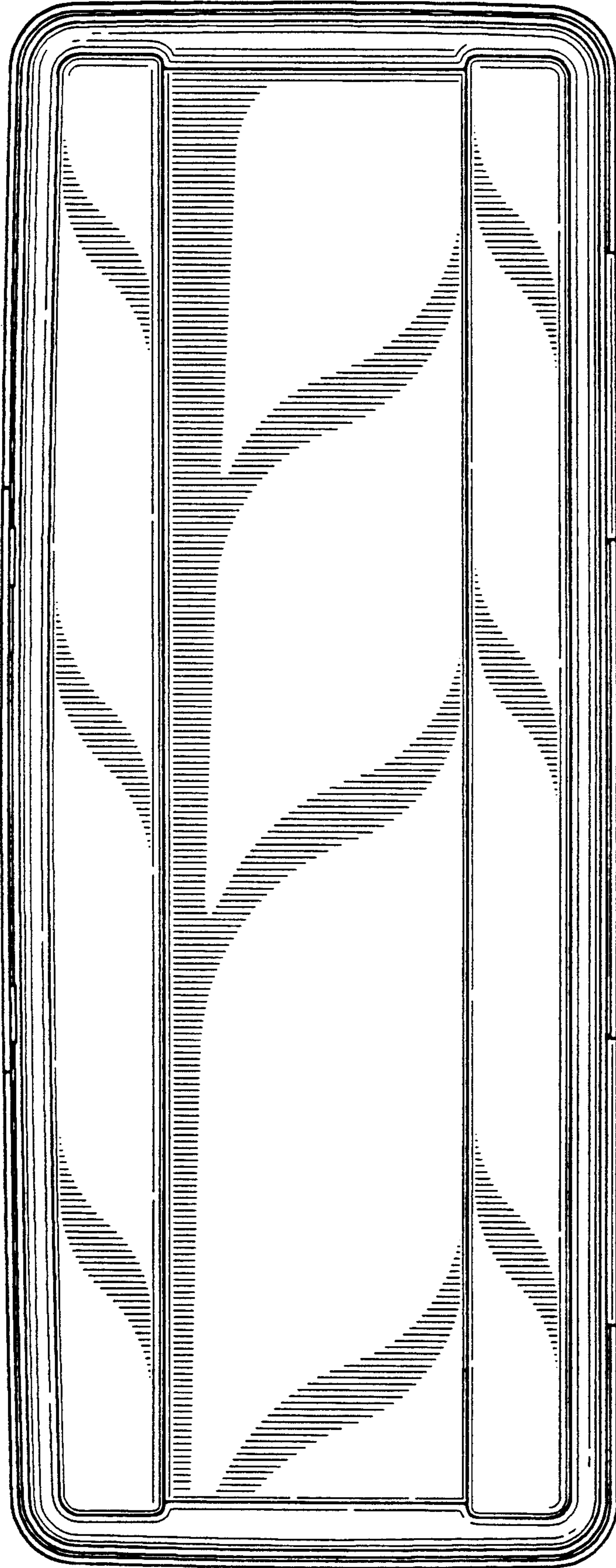

FIG-5

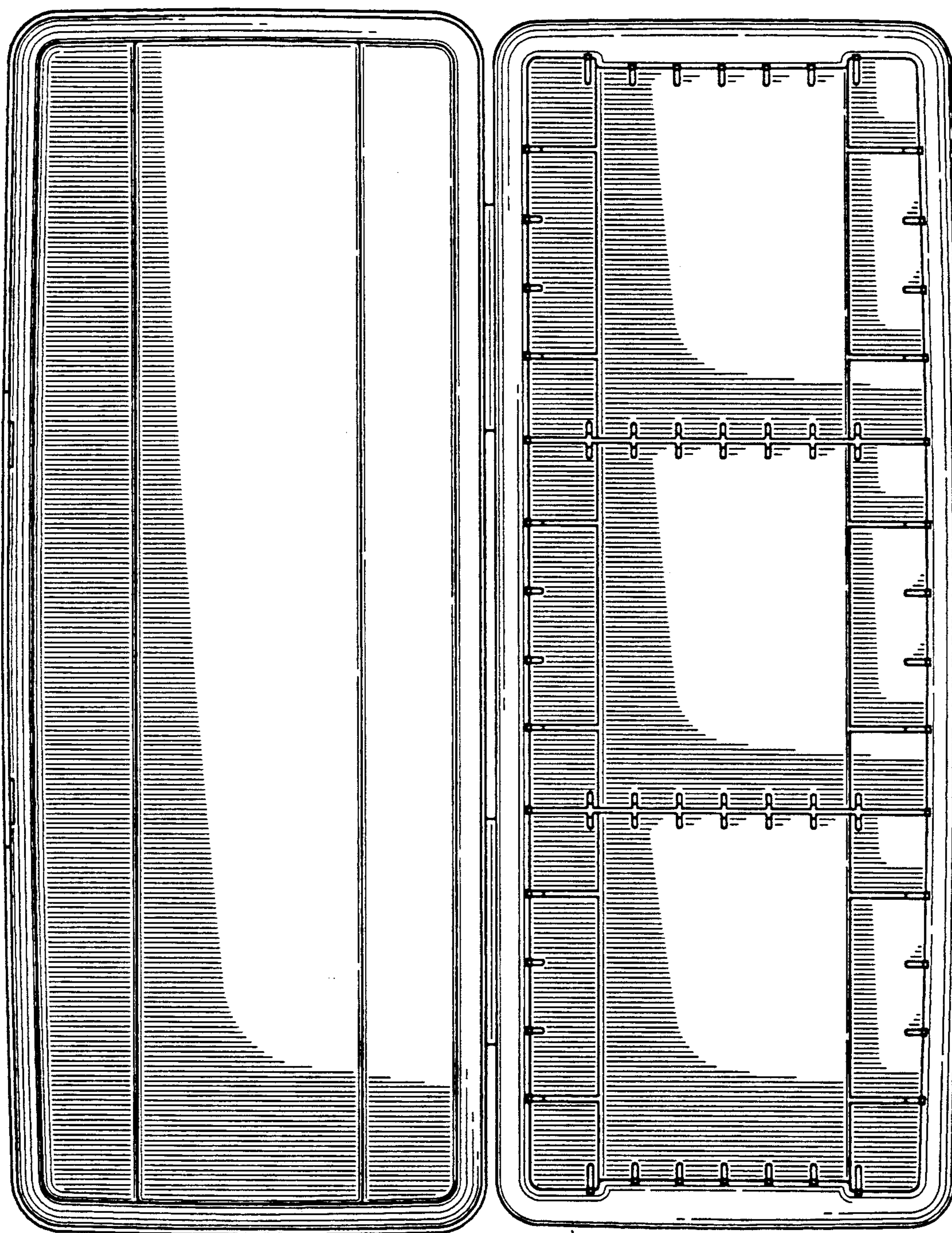

FIG-6

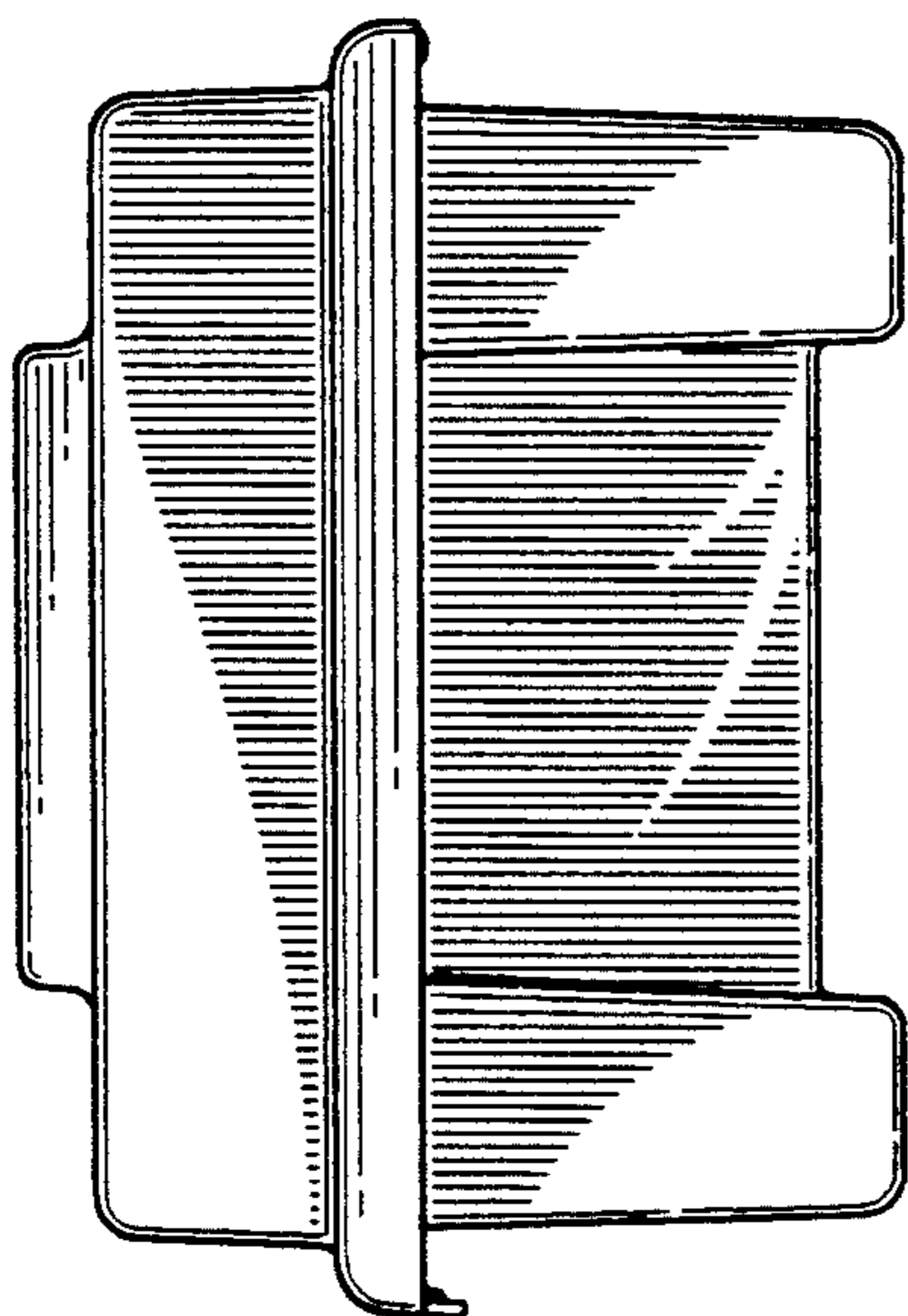

FIG-7

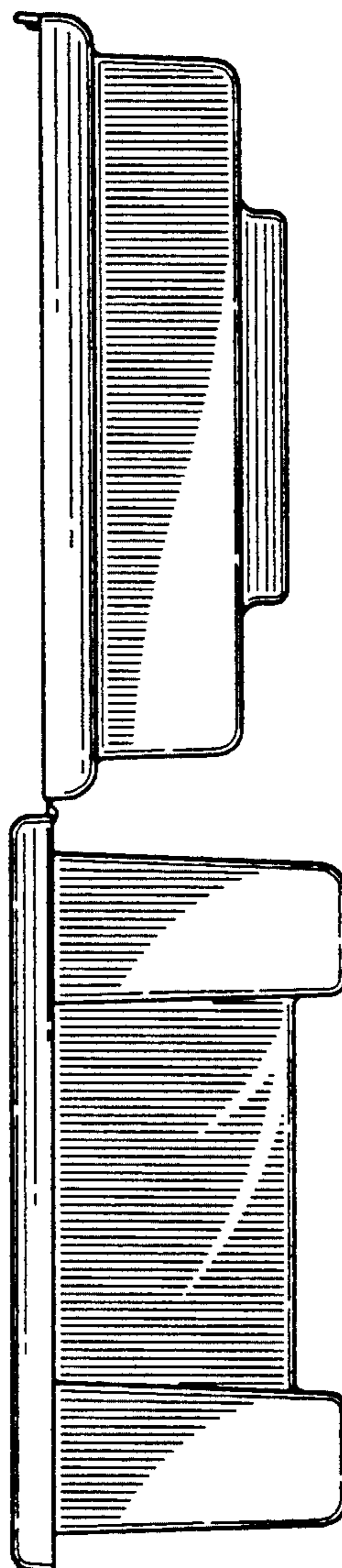

FIG-8