



US00D348479S

# United States Patent [19]

[11] Patent Number: **Des. 348,479**

Ujita et al.

[45] Date of Patent: **\*\* Jul. 5, 1994**

## [54] INK CARTRIDGE FOR PRINTER

[75] Inventors: **Toshihiko Ujita**, Yamato; **Kenjiro Watanabe**, Tokyo; **Yasuo Kotaki**, Yokohama; **Kazuhiro Nakazima**, Yokohama; **Koji Yamakawa**, Yokohama; **Torachika Osada**, Yokohama; **Hidemi Kubota**, Komae; **Yohei Sato**, Yokohama; **Keiichiro Tsukuda**, Kawasaki; **Masanori Takenouchi**, Yokohama; **Kayomi Sato**, Kawasaki, all of Japan

[73] Assignee: **Canon Kabushiki Kaisha**, Tokyo, Japan

[\*\*] Term: **14 Years**

[21] Appl. No.: **2,942**

[22] Filed: **Dec. 23, 1992**

### [30] Foreign Application Priority Data

Jul. 17, 1992 [JP] Japan ..... 4-21466  
 [52] U.S. Cl. .... D18/56  
 [58] Field of Search ..... 346/140 R, 140 PD, 75; 400/471; 101/333-335; D18/12, 40, 43, 56

## [56] References Cited

### U.S. PATENT DOCUMENTS

D. 327,496	6/1992	Karita et al.	D18/56
D. 331,939	12/1992	Ujita	D18/12
D. 338,224	8/1993	Ujita	D18/12
D. 338,232	8/1993	Kotaki et al.	D18/56
D. 338,234	8/1993	Watanabe et al.	D18/56
D. 338,489	8/1993	Ujita et al.	D18/56
4,131,899	12/1978	Christou	346/140 R
4,992,802	2/1991	Dion et al.	346/75
5,187,498	2/1993	Burger	346/140 R

### FOREIGN PATENT DOCUMENTS

0004954	1/1988	Japan	346/140 R
---------	--------	-------	-----------

*Primary Examiner*—Cathy Anne MacCormac  
*Attorney, Agent, or Firm*—Fitzpatrick, Cella, Harper & Scinto

## [57] CLAIM

The ornamental design for an ink cartridge for printer, as shown and described.

## DESCRIPTION

FIG. 1 is a front elevational view of an ink cartridge for printer showing our new design;  
 FIG. 2 is a rear elevational view thereof;  
 FIG. 3 is a top plan view thereof;  
 FIG. 4 is a bottom plan view thereof;  
 FIG. 5 is a left side elevational view thereof;  
 FIG. 6 is a right side elevational view thereof; and,  
 FIG. 7 is a perspective view thereof.

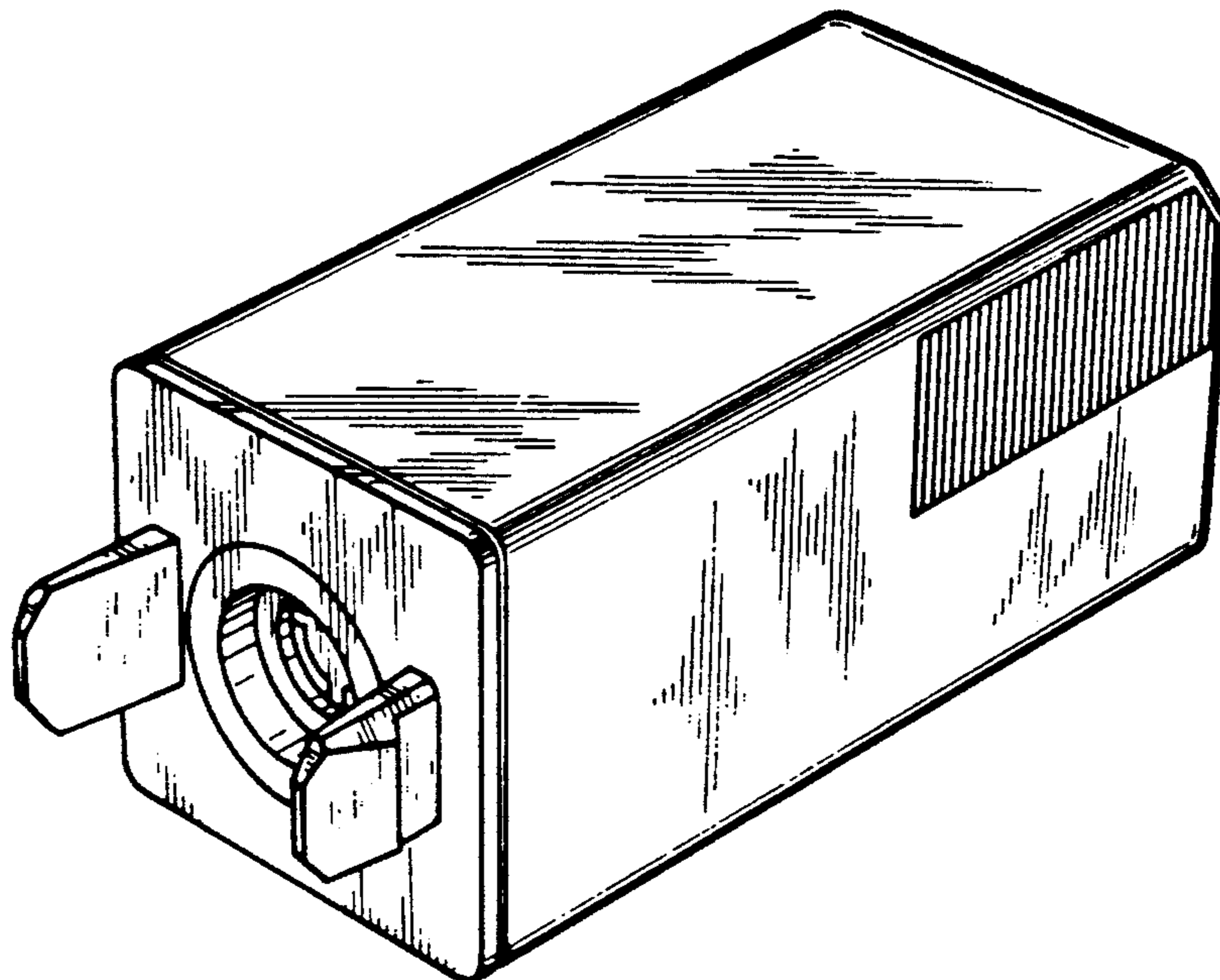

*FIG. 1*

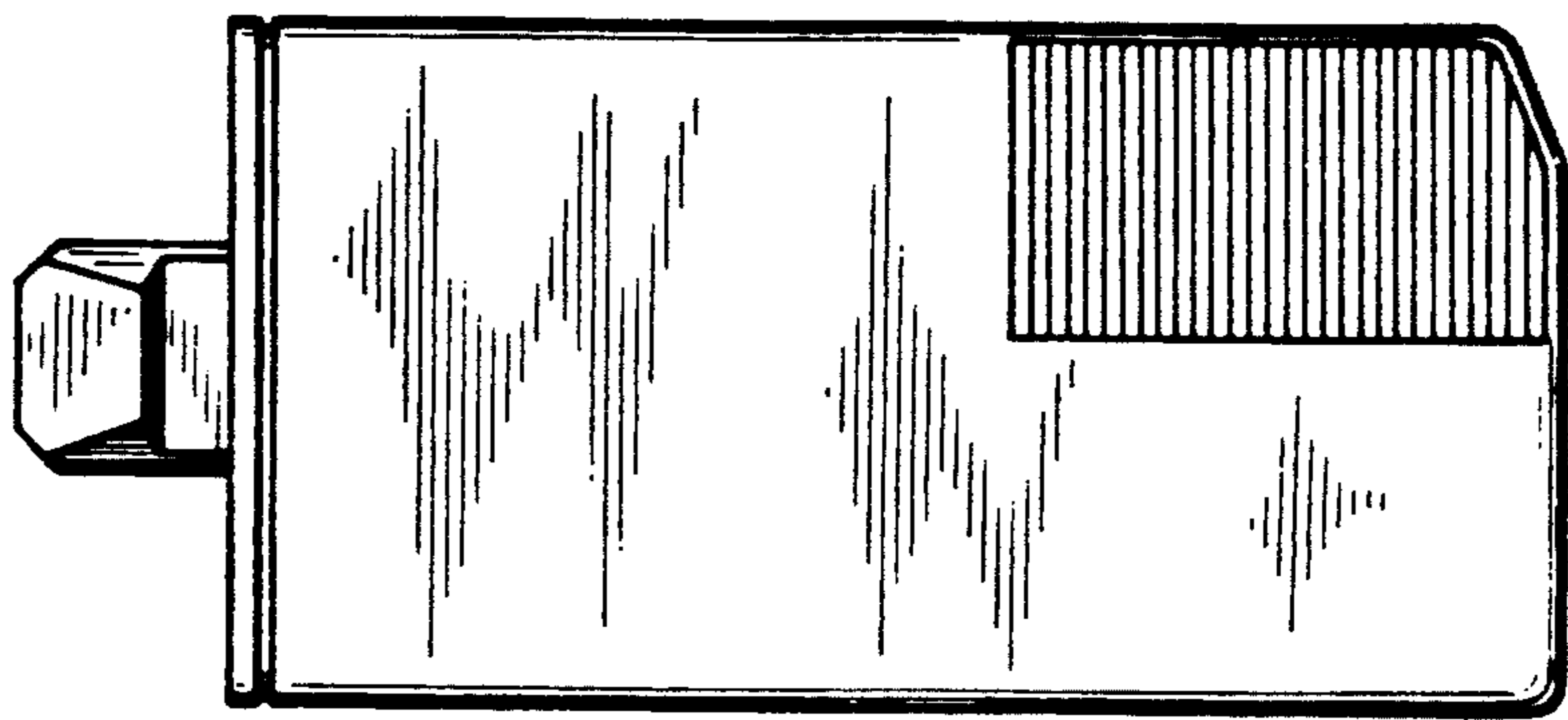

*FIG. 2*

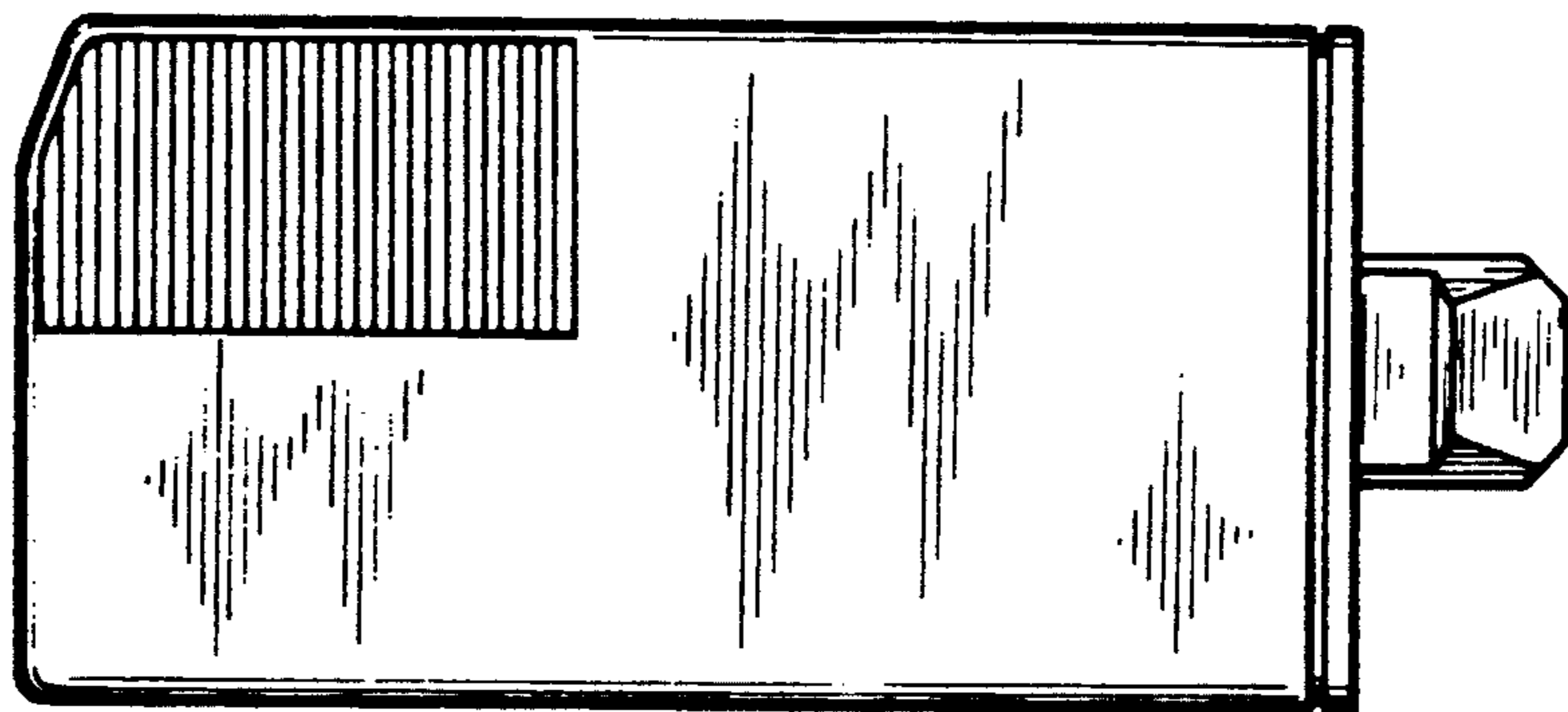

*FIG. 3*

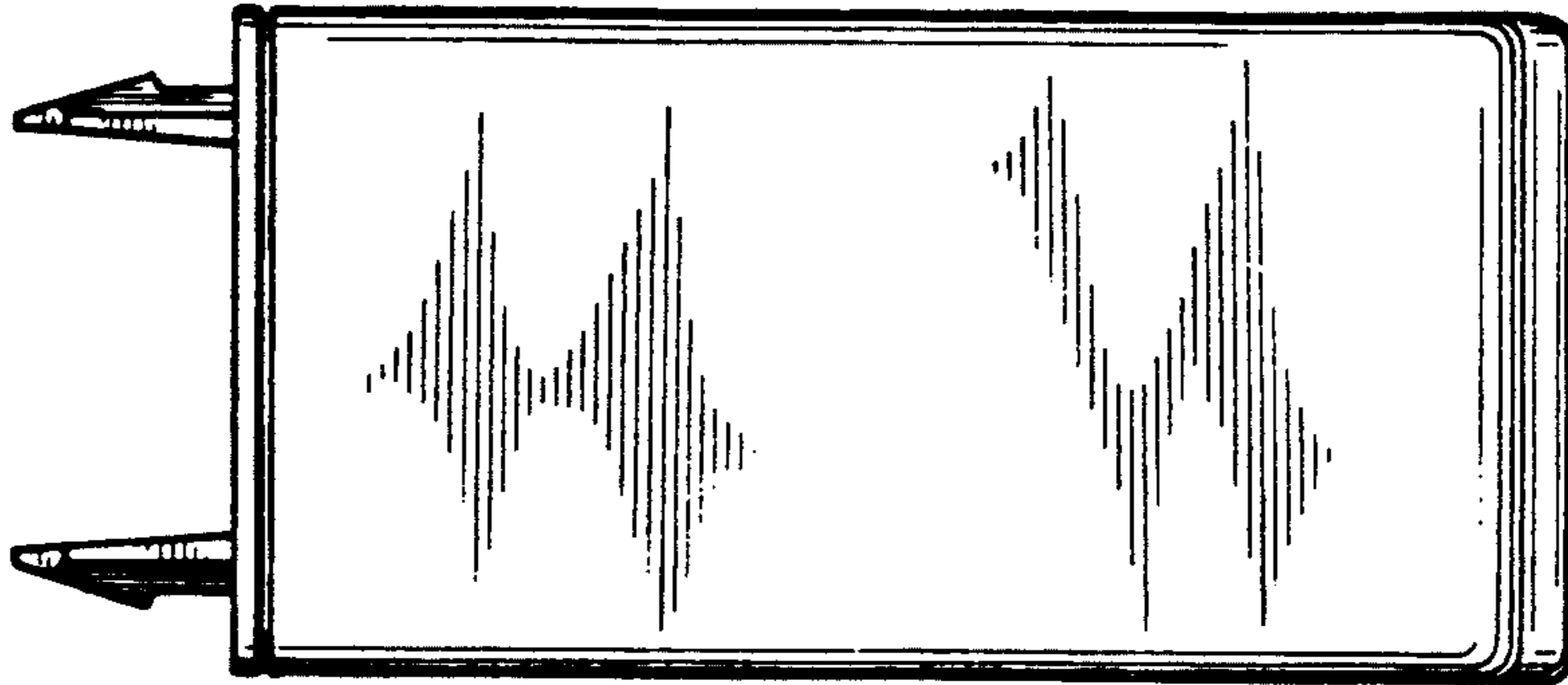

*FIG. 4*

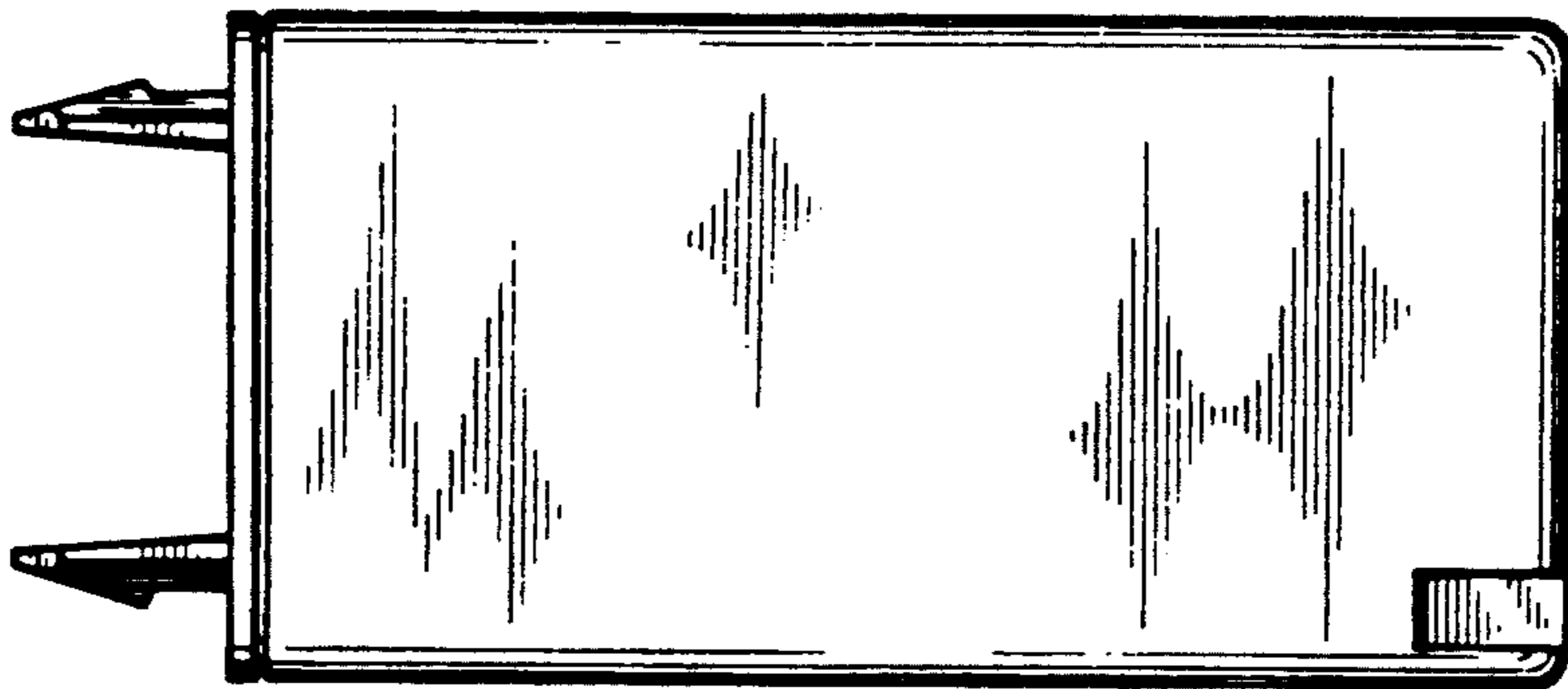

*FIG. 5*

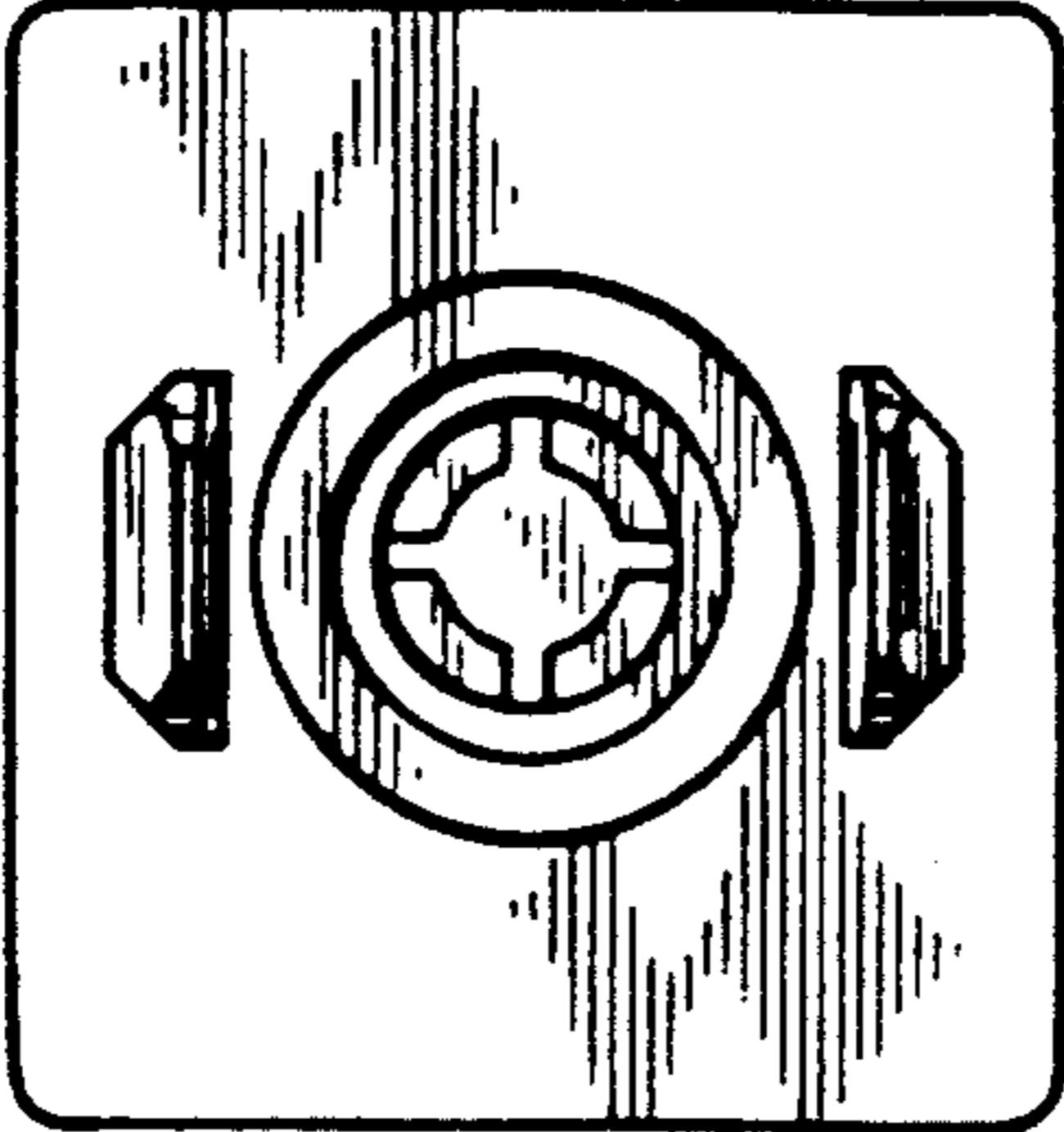

*FIG. 6*

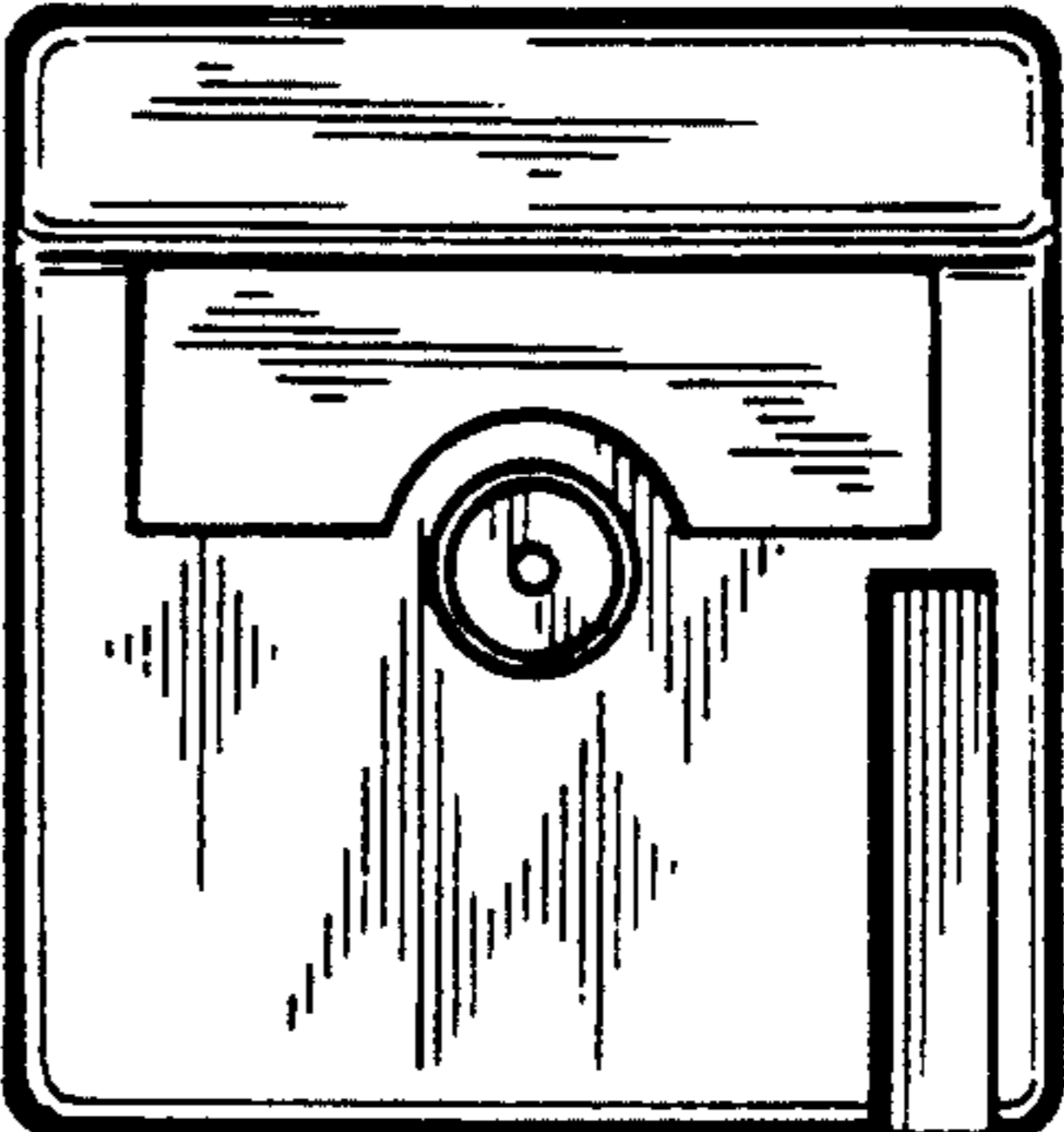

*FIG. 7*

