



US00D348478S

United States Patent [19]

[11] Patent Number: **Des. 348,478**

Ujita et al.

[45] Date of Patent: **** Jul. 5, 1994**

[54] **INK CARTRIDGE FOR PRINTER**

[75] Inventors: **Toshihiko Ujita, Yamato; Noriaki Miyamoto, Yokohama, both of Japan**

[73] Assignee: **Canon Kabushiki Kaisha, Tokyo, Japan**

[**] Term: **14 Years**

[21] Appl. No.: **2,060**

[22] Filed: **Dec. 1, 1992**

[52] U.S. Cl. **D18/56**

[58] Field of Search **346/140 PD, 140 R, 75; 400/471; 101/333-335; D18/56, 40, 43**

[56] **References Cited**

U.S. PATENT DOCUMENTS

| | | | |
|------------|---------|----------------------|--------|
| D. 280,913 | 10/1985 | Nibley et al. | D18/56 |
| D. 281,333 | 11/1985 | Nibley et al. | D18/56 |
| D. 285,312 | 8/1986 | Jennings et al. | D18/12 |
| D. 313,812 | 1/1991 | Yomo | D18/56 |
| D. 321,900 | 11/1991 | Kumagai | D18/56 |
| D. 325,743 | 4/1992 | Kojima et al. | D18/56 |
| D. 330,387 | 10/1992 | Kawakami | D18/56 |

| | | | |
|------------|---------|----------------|-----------|
| D. 331,939 | 12/1992 | Ujita | D18/12 |
| D. 332,278 | 1/1993 | Miyamoto | D18/43 |
| D. 334,403 | 3/1993 | Kawakami | D18/56 |
| D. 338,912 | 8/1993 | Miyamoto | D18/56 |
| 4,568,954 | 2/1986 | Rosback | 346/140 R |
| 4,855,762 | 8/1989 | Suzuki | 346/140 R |
| 5,113,206 | 5/1992 | Fukazawa | 346/140 R |
| 5,157,421 | 10/1992 | Kitahara | 346/140 R |

Primary Examiner—Cathy Anne MacCormac
Attorney, Agent, or Firm—Fitzpatrick, Cella, Harper & Scinto

[57] **CLAIM**

The ornamental design for an ink cartridge for printer, as shown and described.

DESCRIPTION

FIG. 1 is a front elevational view of an ink cartridge for printer showing our new design; FIG. 2 is a rear elevational view thereof; FIG. 3 is a top plan view thereof; FIG. 4 is a bottom plan view thereof; FIG. 5 is a left side elevational view thereof; FIG. 6 is a right side elevational view thereof; and, FIG. 7 is a perspective view thereof.

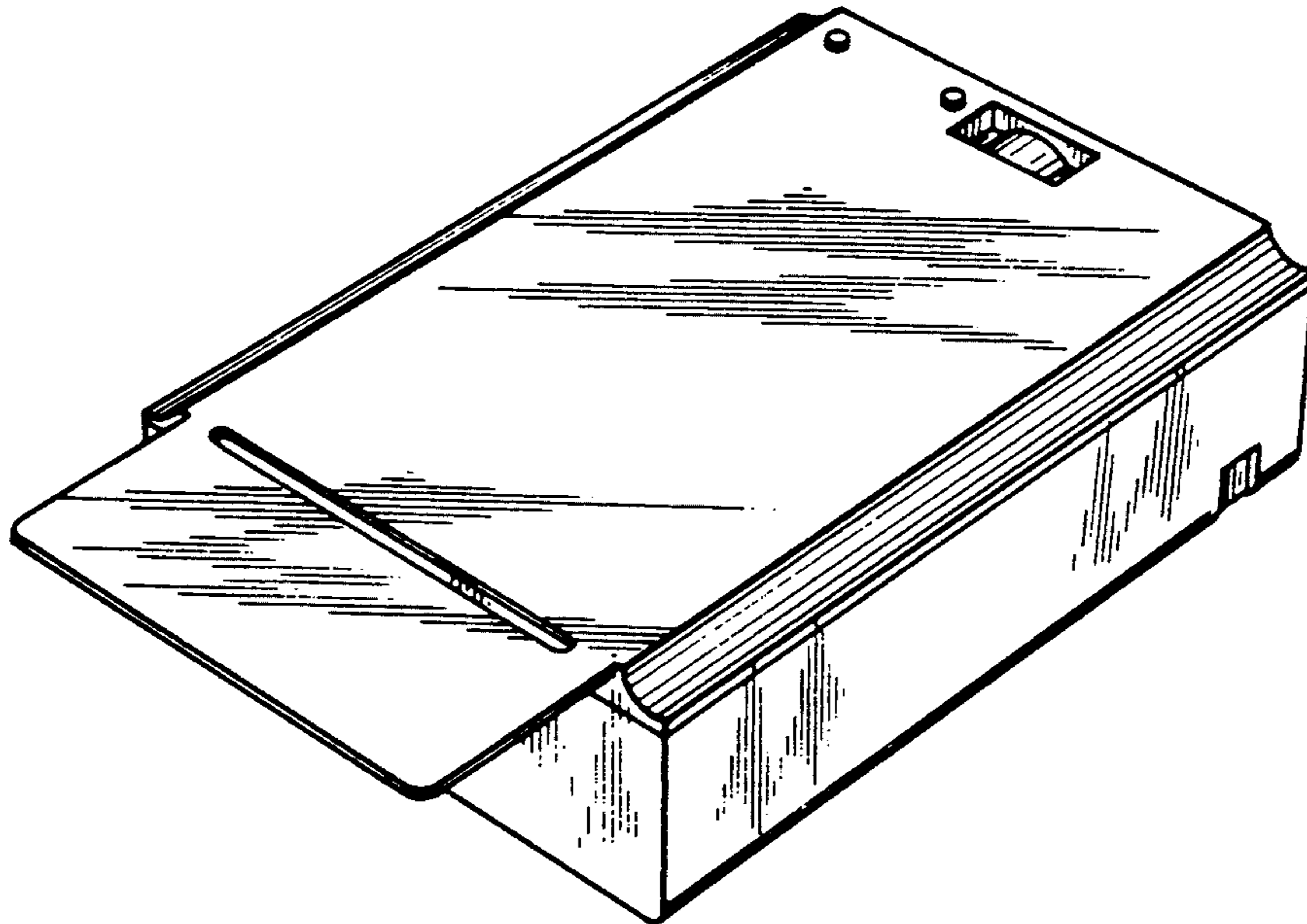

FIG. 1

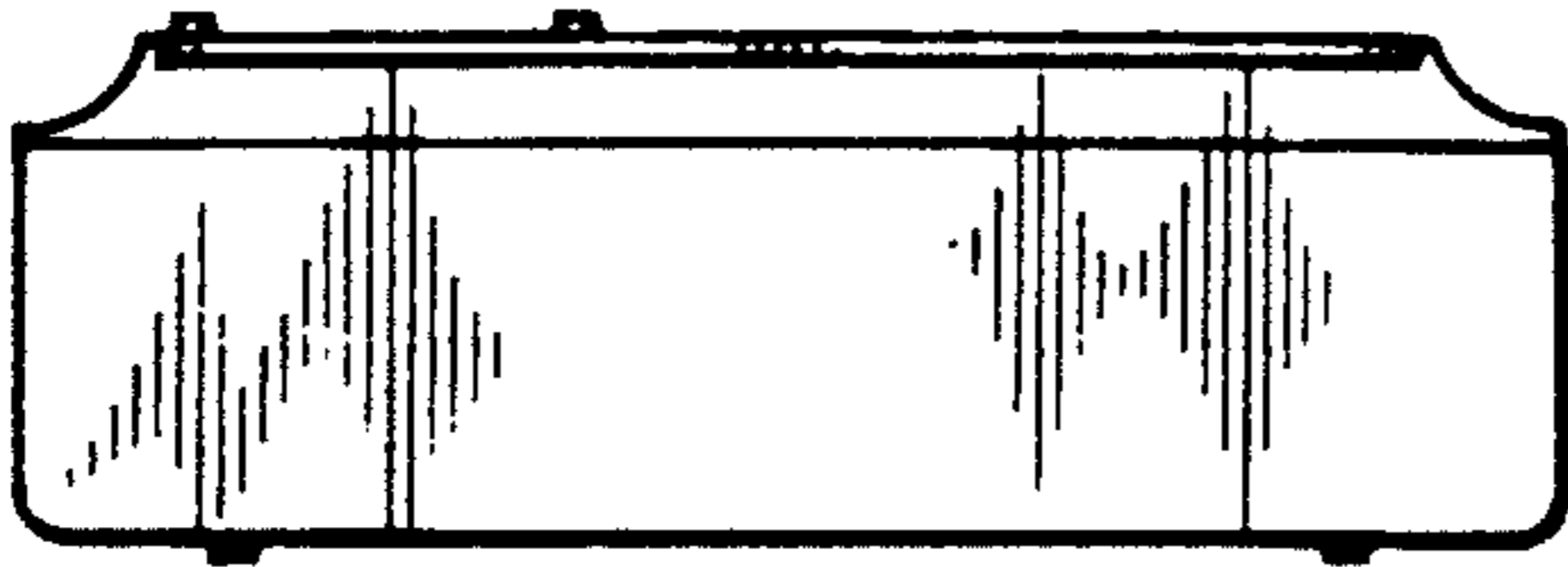

FIG. 2

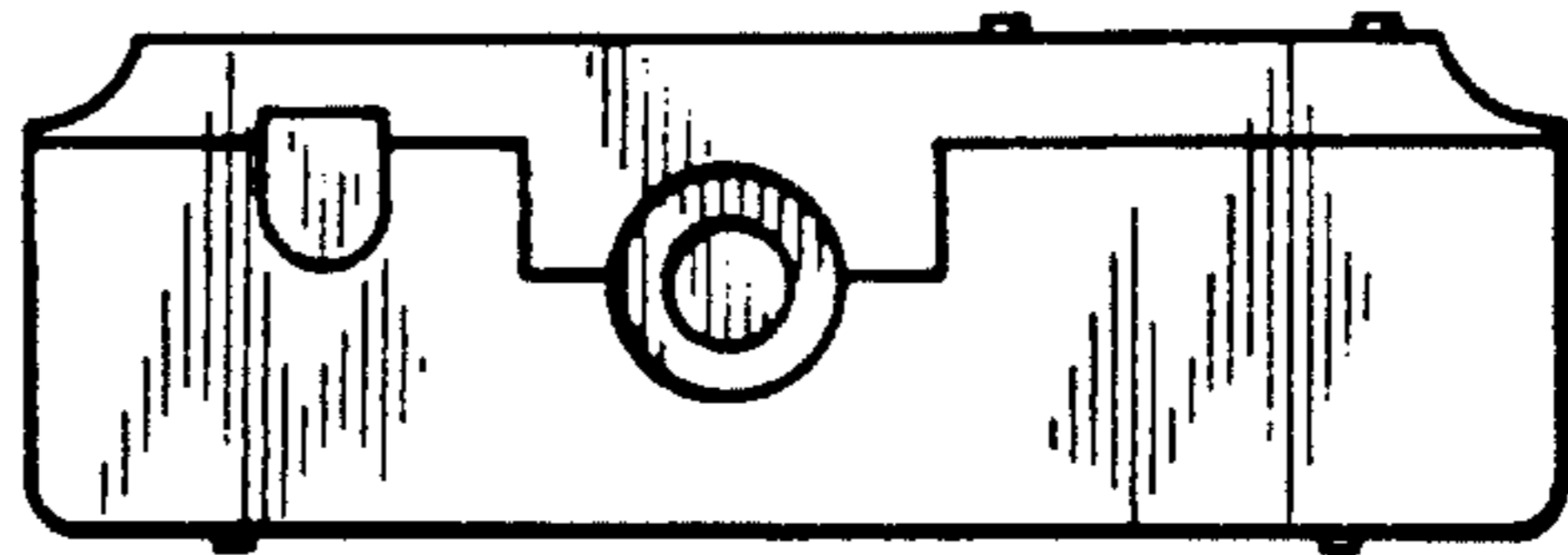

FIG. 3

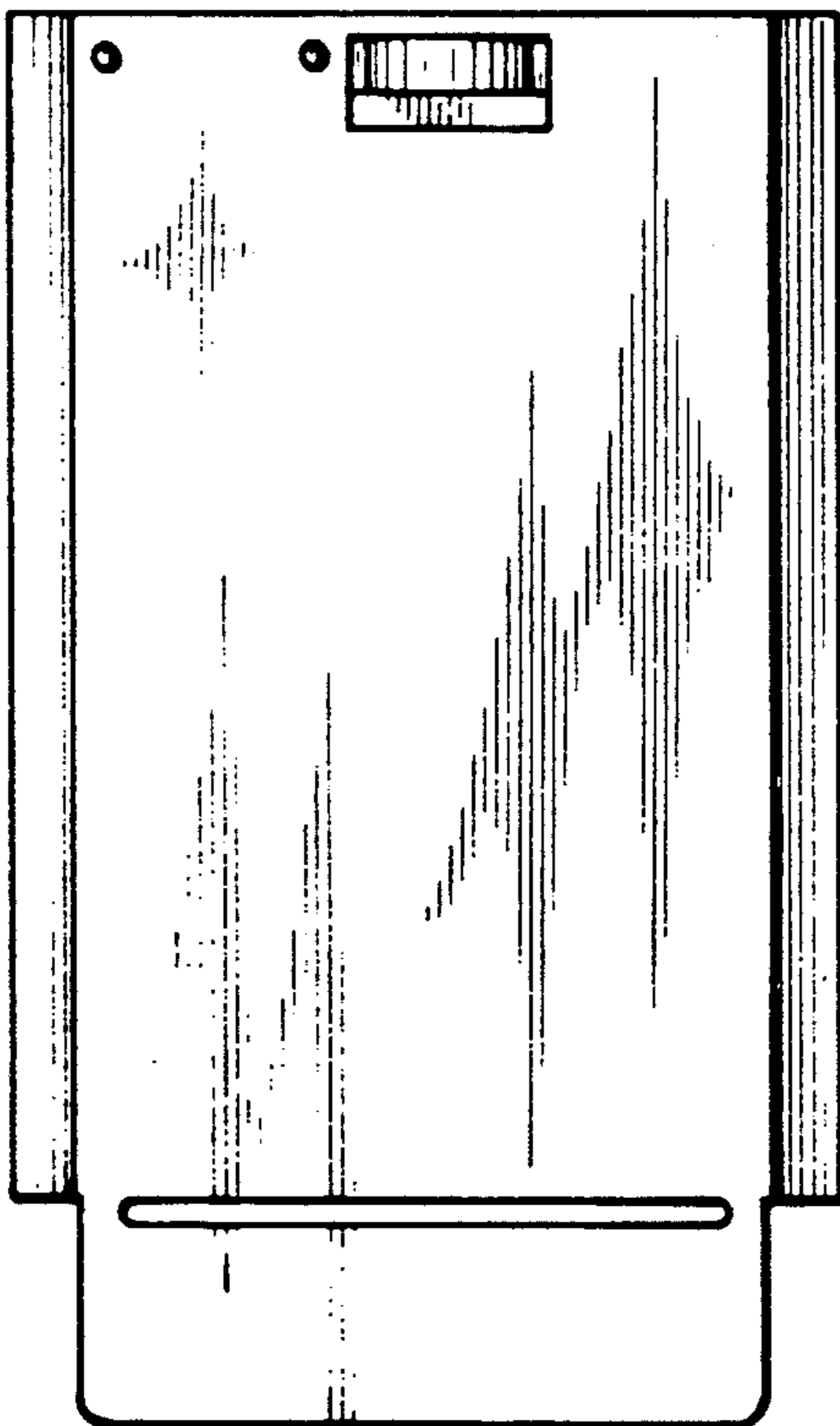

FIG. 4

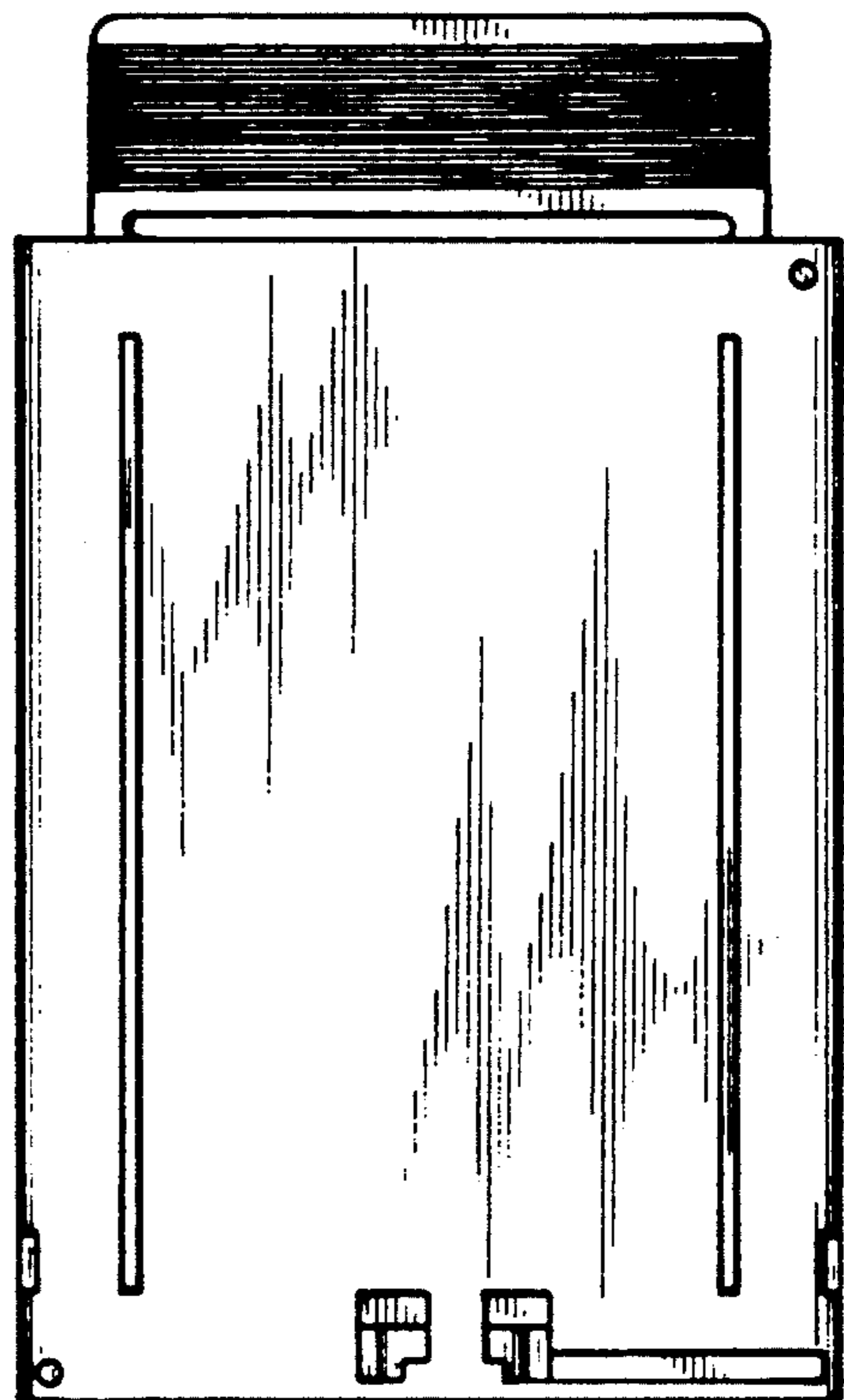

FIG. 5

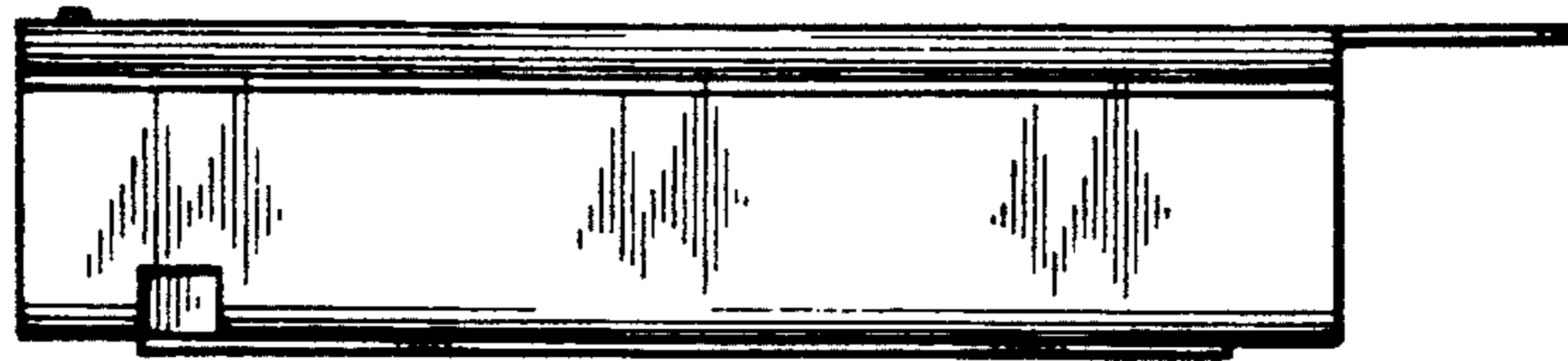

FIG. 6

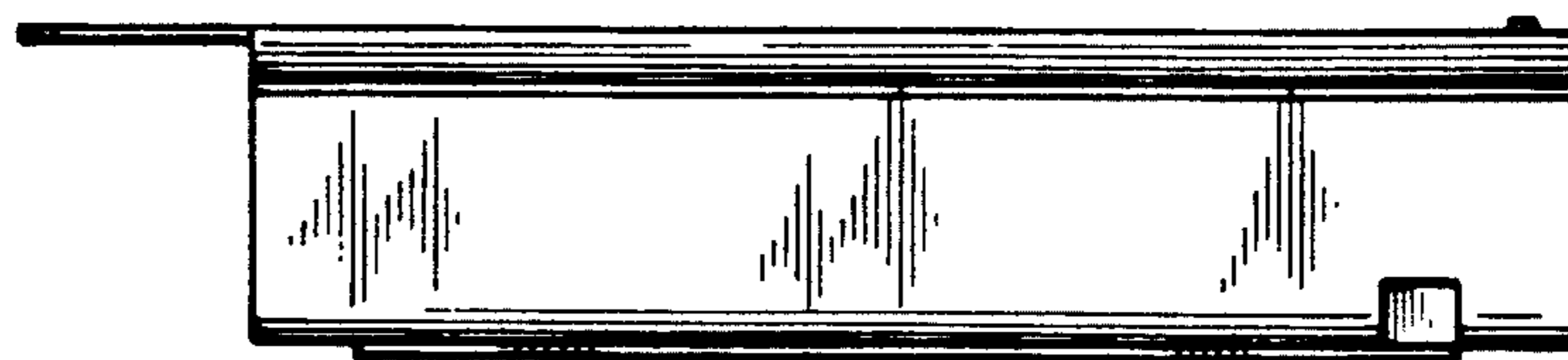

FIG. 7

