



US00D348456S

United States Patent [19]

[11] Patent Number: **Des. 348,456**

Renk, Jr.

[45] Date of Patent: **** Jul. 5, 1994**

[54] **TELEVISION RECEIVER**

D. 317,304 6/1991 Renk D14/126
D. 338,667 8/1993 Renk D14/126

[75] Inventor: **Thomas E. Renk, Jr.**, Indianapolis, Ind.

Primary Examiner—B. J. Bullock
Assistant Examiner—Richelle Shelton
Attorney, Agent, or Firm—Woodard, Emhardt, Naughton, Moriarty & McNett

[73] Assignee: **Thompson Consumer Electronics, Inc.**, Indianapolis, Ind.

[**] Term: **14 Years**

[57] **CLAIM**

[21] Appl. No.: **882,103**

The ornamental design for a television receiver, as shown and described.

[22] Filed: **May 12, 1992**

[52] U.S. Cl. **D14/126**

[58] Field of Search 312/7.2; 358/56, 60, 358/237-239, 254; D14/113, 114, 124-126, 128, 239, 299

DESCRIPTION

FIG. 1 is a top, front and right side perspective view of a television receiver showing my new design; FIG. 2 is a top, rear and left side perspective view thereof; FIG. 3 is an enlarged front elevational view thereof; FIG. 4 is an enlarged top plan view thereof; FIG. 5 is an enlarged rear elevational view thereof; and, FIG. 6 is an enlarged left side elevational view thereof.

[56] **References Cited**

U.S. PATENT DOCUMENTS

D. 186,629 11/1959 Whipple D14/126
D. 308,372 6/1990 Satto et al. D14/126

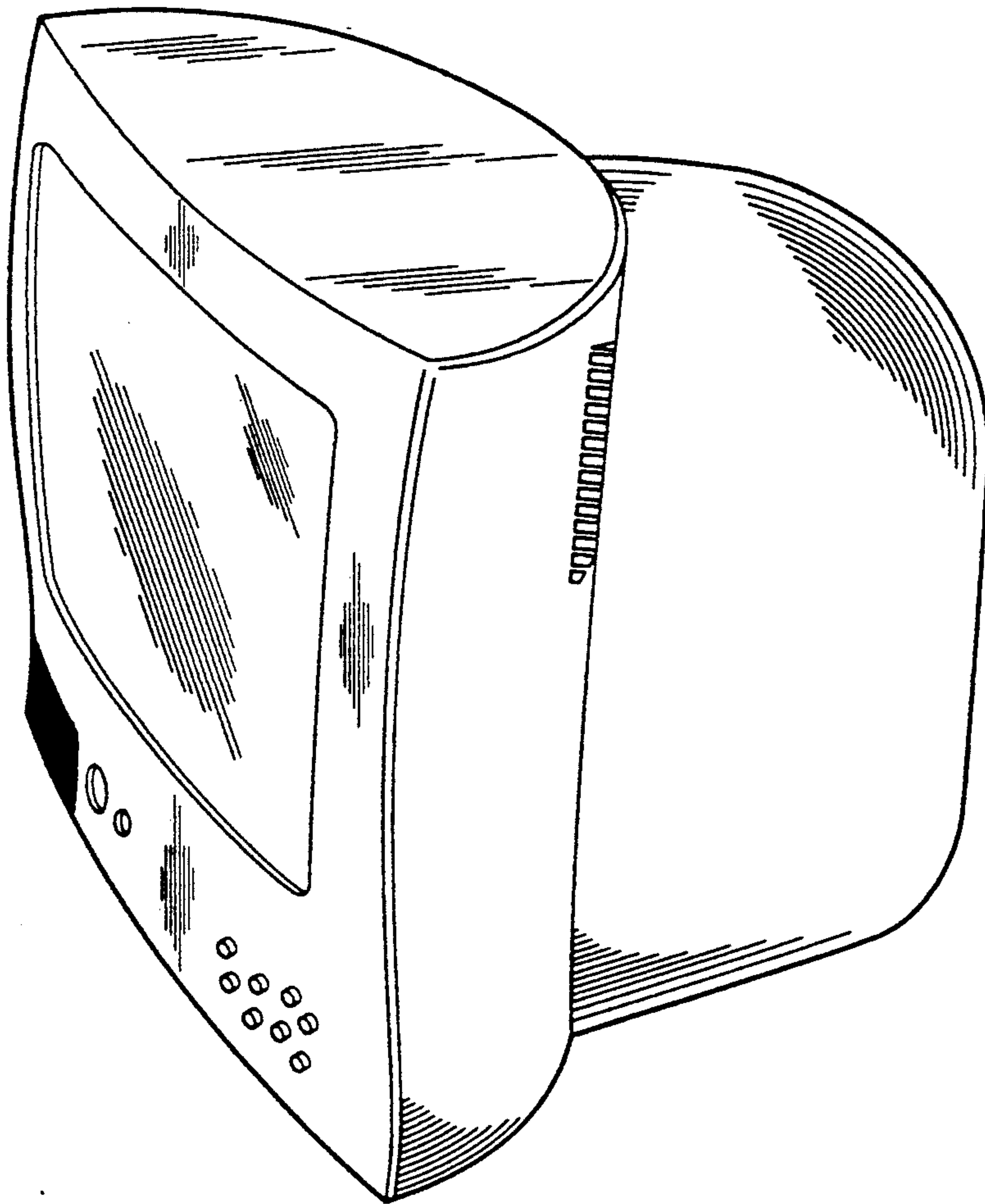

Fig. 1

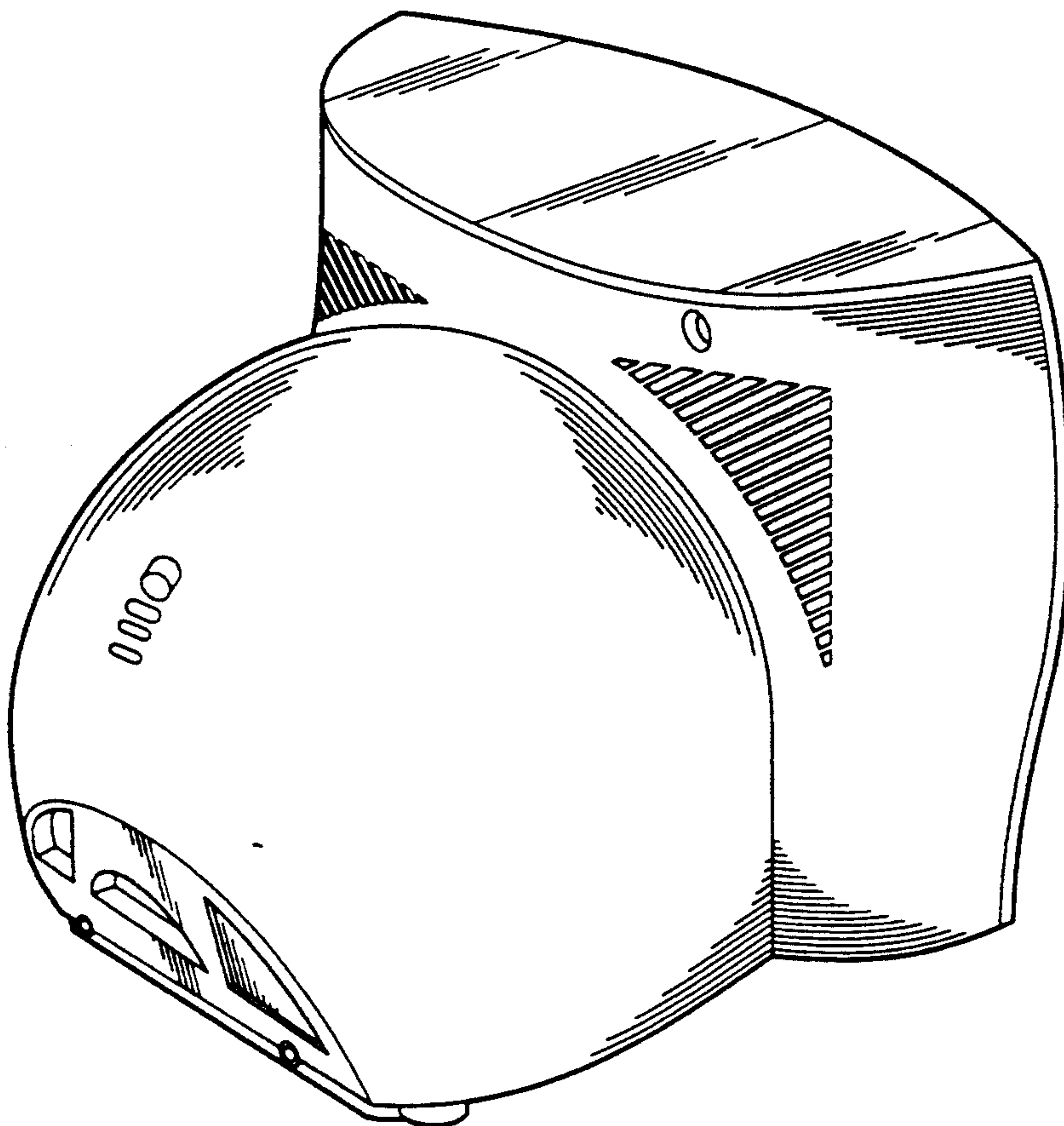
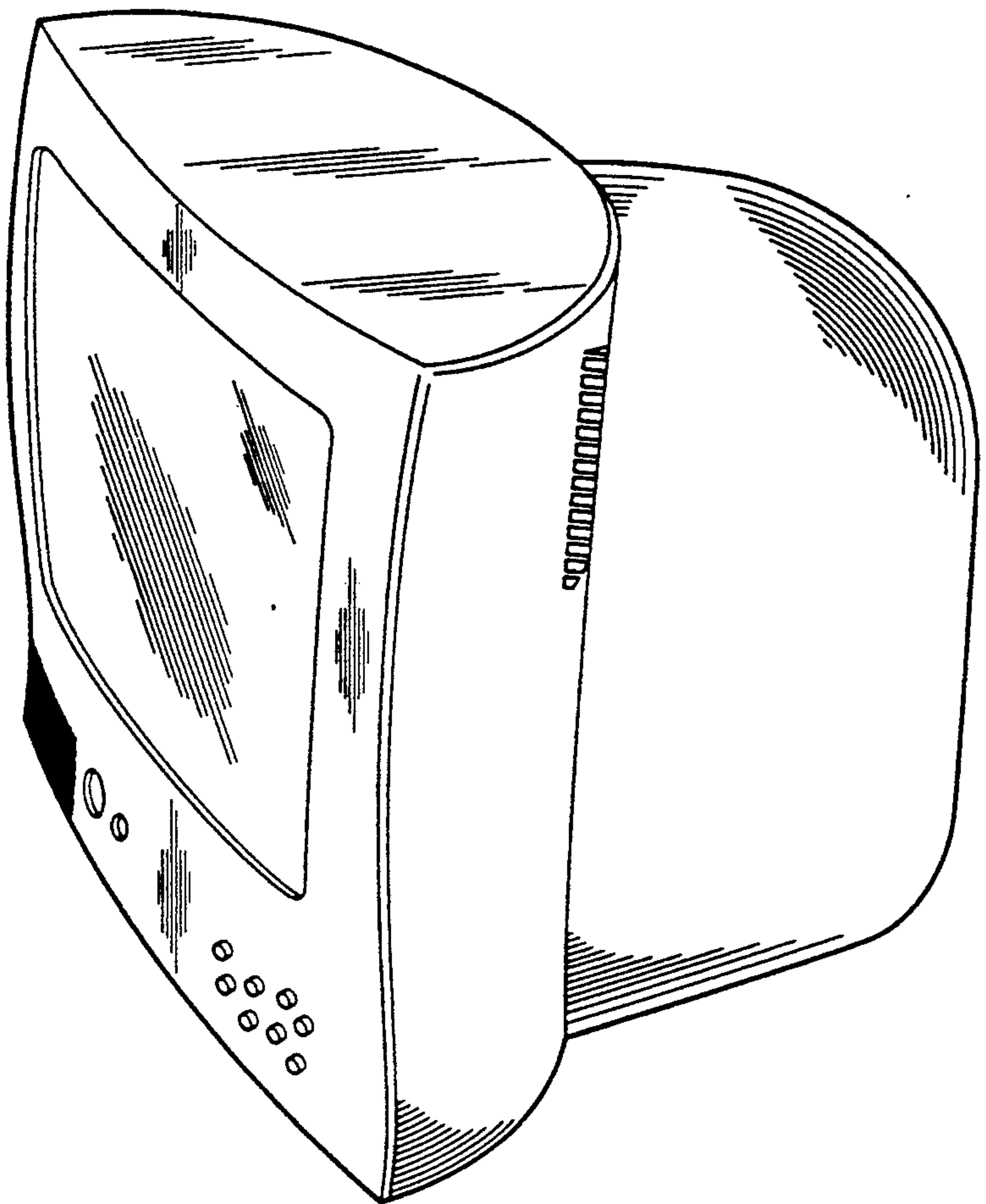

Fig. 2

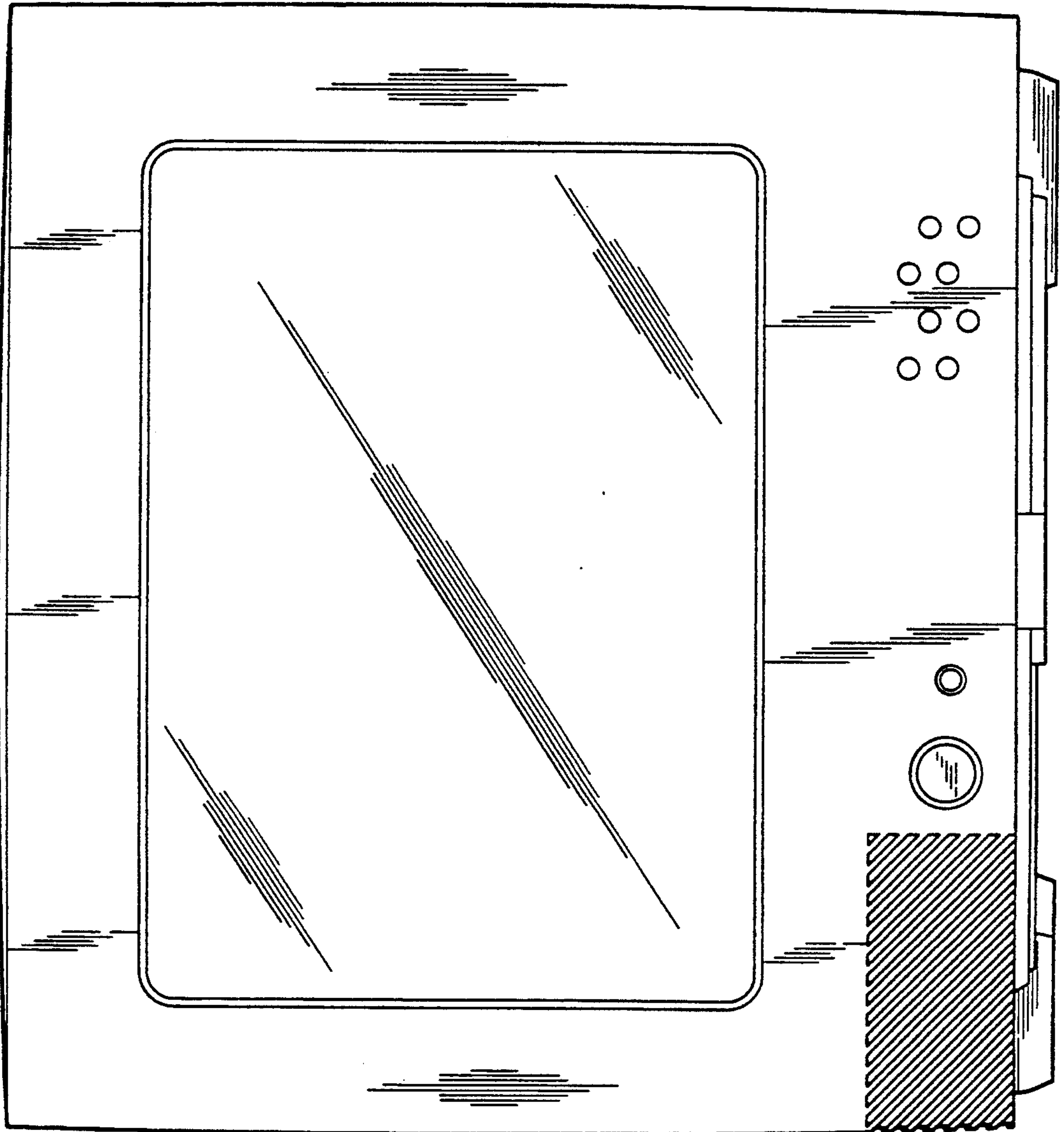

Fig. 3

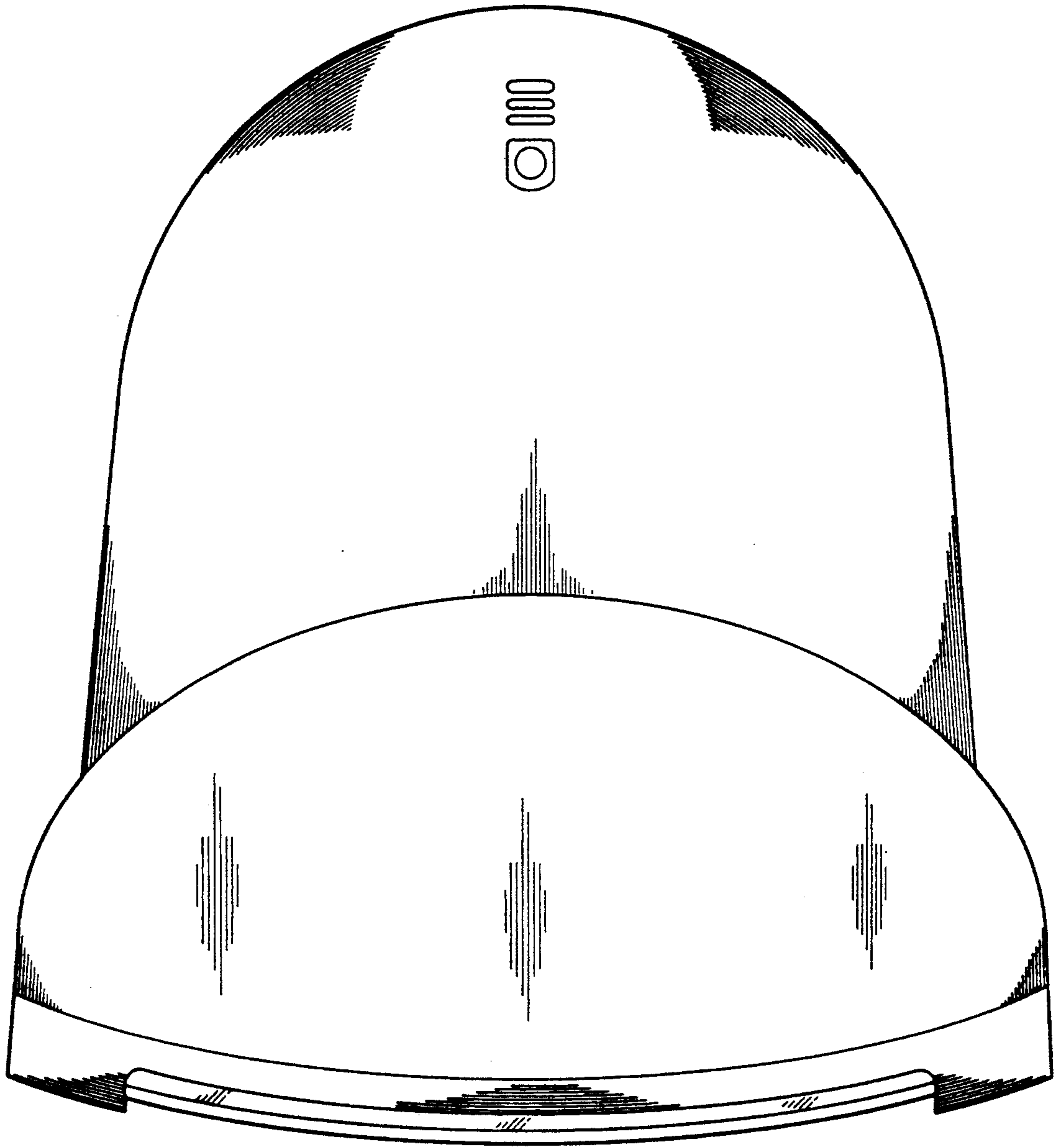

Fig. 4

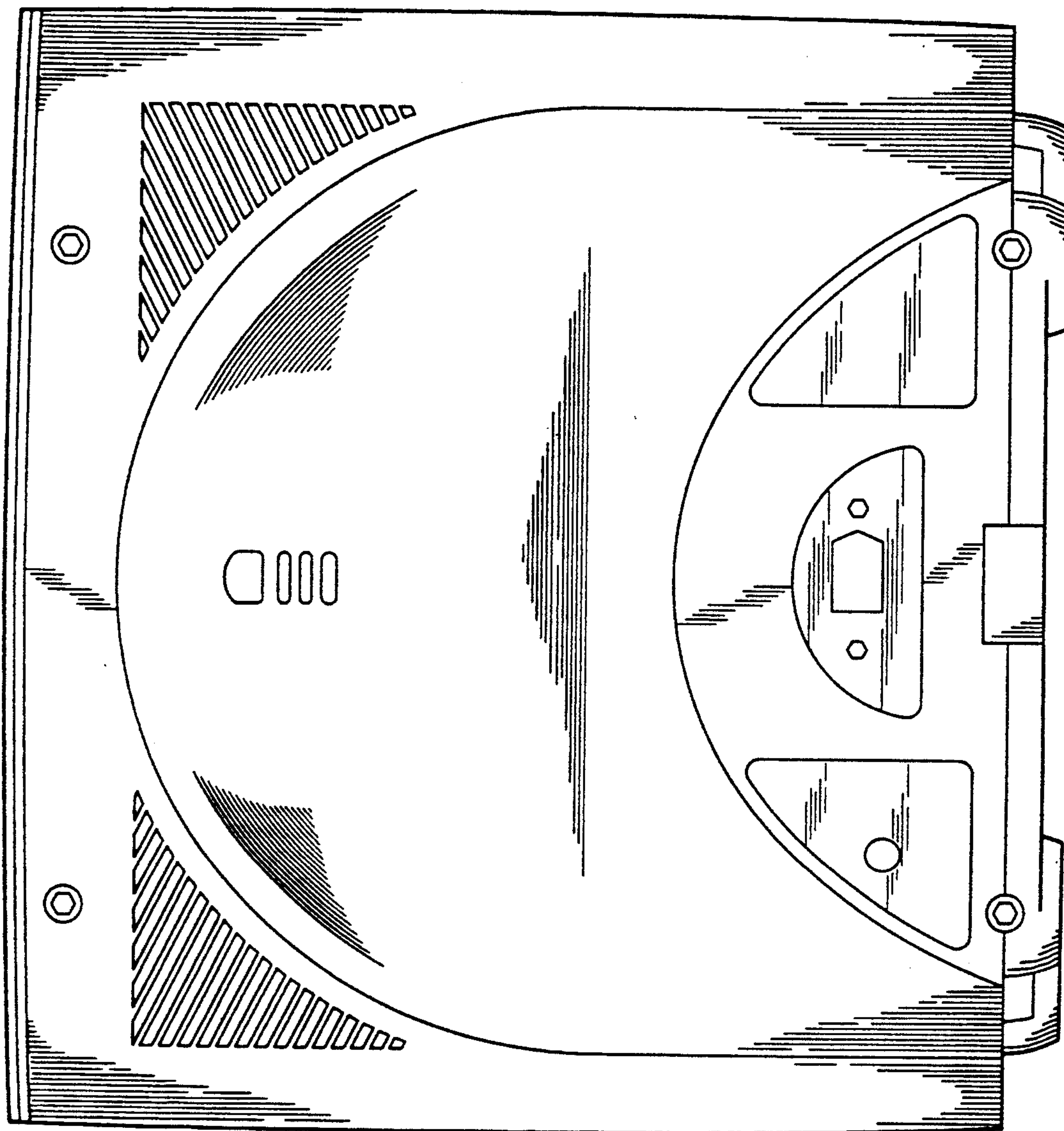

Fig. 5

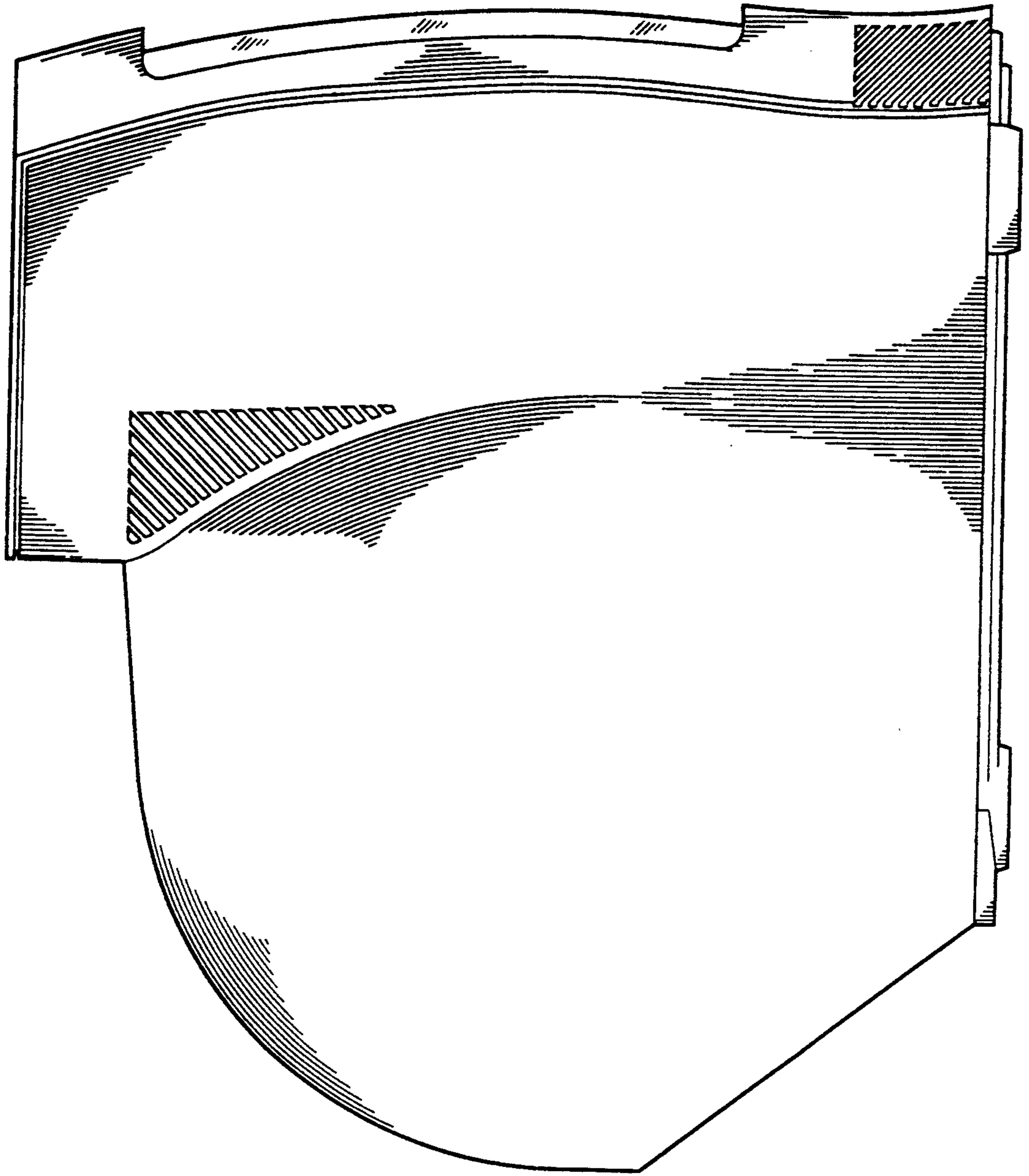

Fig. 6