



US00D348373S

# United States Patent [19]

[11] Patent Number: **Des. 348,373**

**Webster**

[45] Date of Patent: **\*\* Jul. 5, 1994**

[54] **MULTIPLE BEVERAGE BREWER**

D. 328,218 7/1992 Pearce ..... D7/300 X  
4,603,620 8/1986 Daugherty ..... D7/309 X

[75] Inventor: **Joseph P. Webster**, St. Charles County, Mo.

**OTHER PUBLICATIONS**

[73] Assignee: **Newco Enterprises, Inc.**, St. Charles, Mo.

Automatic Coffee Brewer (center bottom), Bun-O-Matic, The Office Feb. 1987.

[\*\*] Term: **14 Years**

*Primary Examiner*—Alan P. Douglas  
*Assistant Examiner*—M. N. Pandozzi  
*Attorney, Agent, or Firm*—Paul M. Denk

[21] Appl. No.: **922,671**

[57] **CLAIM**

[22] Filed: **Jul. 14, 1992**

The ornamental design for the multiple beverage brewer, as shown and described.

[52] U.S. Cl. .... **D7/311; D7/308; D7/305**

[58] Field of Search ..... **D7/300, 305, 306, 308, D7/309, 310, 311, 313, 307; 99/279; D20/4, 5**

**DESCRIPTION**

[56] **References Cited**

**U.S. PATENT DOCUMENTS**

- D. 214,480 6/1969 Martin ..... D7/309
- D. 292,961 12/1987 Daugherty ..... D7/309
- D. 298,505 11/1988 Frech ..... D7/308
- D. 309,842 8/1990 Frech ..... D7/308

FIG. 1 is an isometric view of the multiple beverage brewer of this invention;  
FIG. 2 is a top view thereof;  
FIG. 3 is a front view thereof;  
FIG. 4 is a back view thereof;  
FIG. 5 is a right side view thereof;  
FIG. 6 is a left side view thereof; and,  
FIG. 7 is a bottom view thereof.

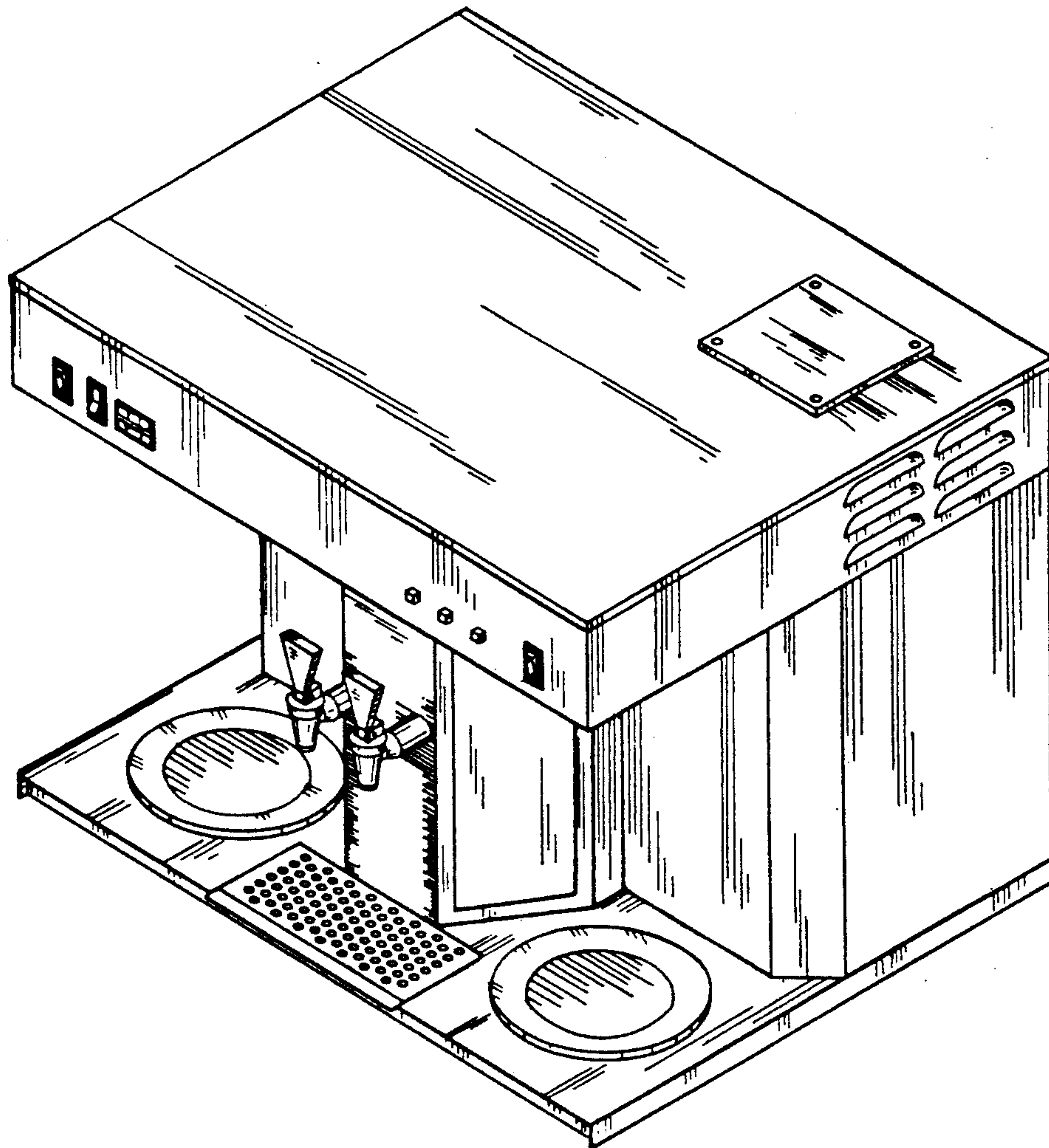

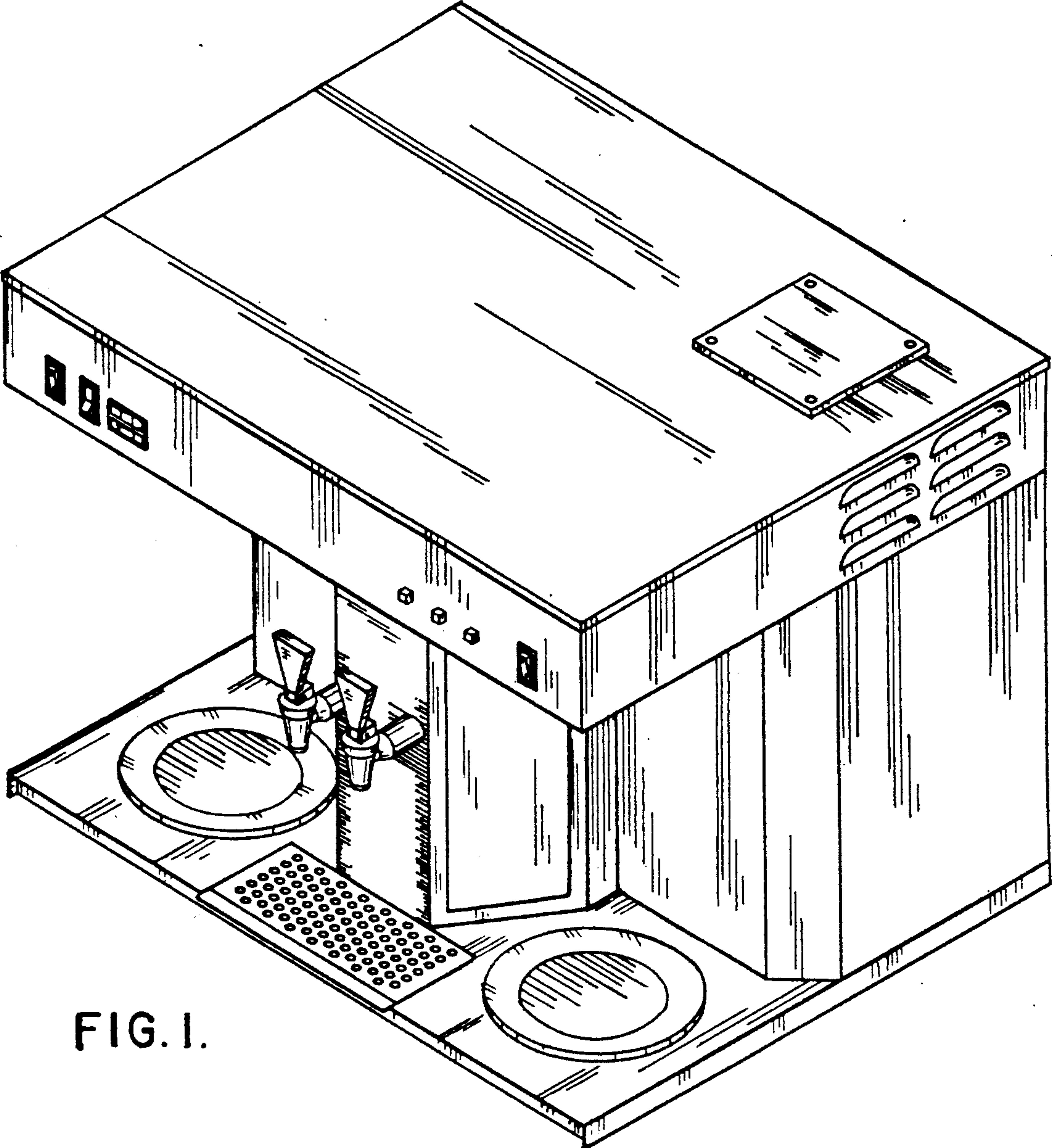

FIG. 1.

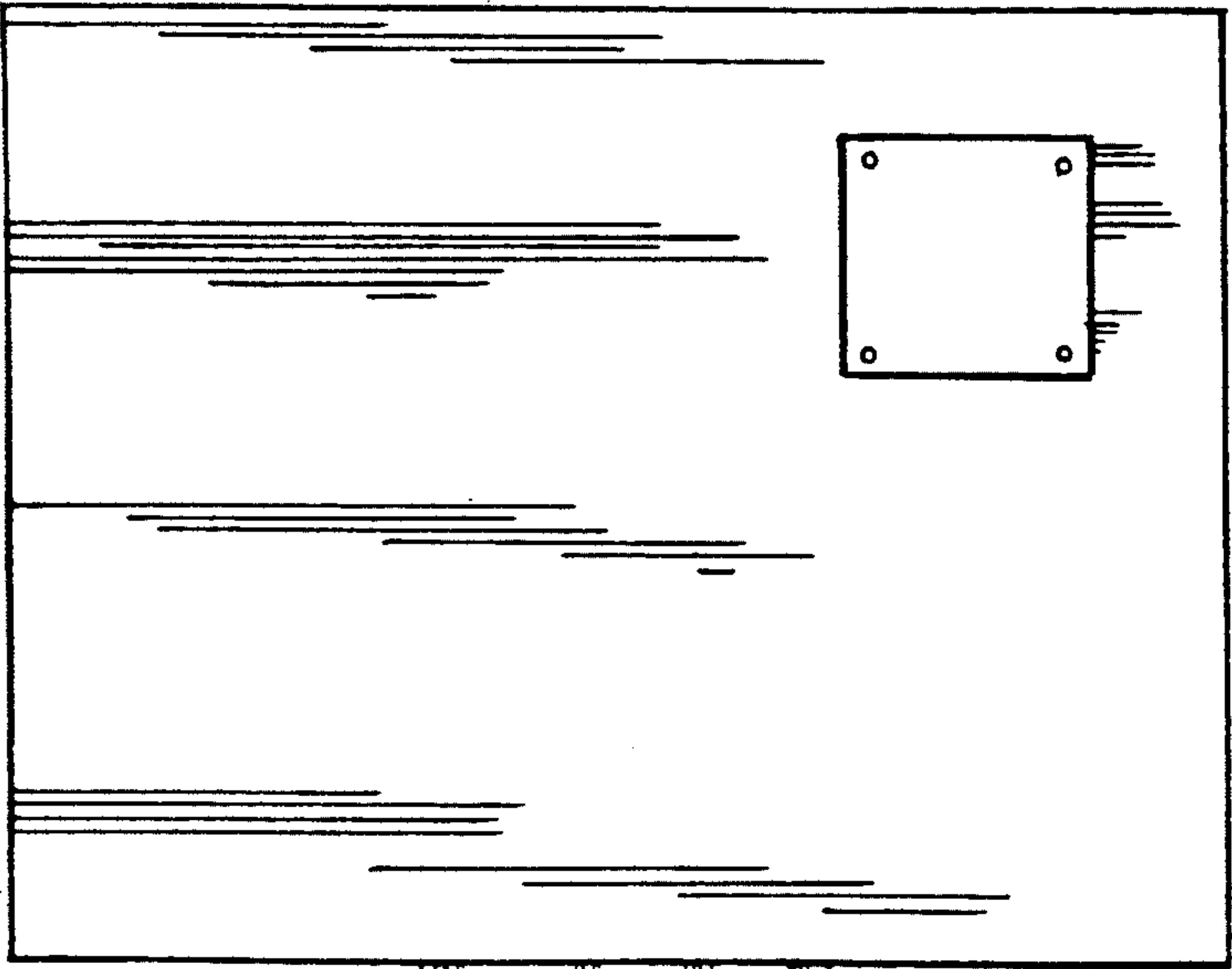

FIG. 2.

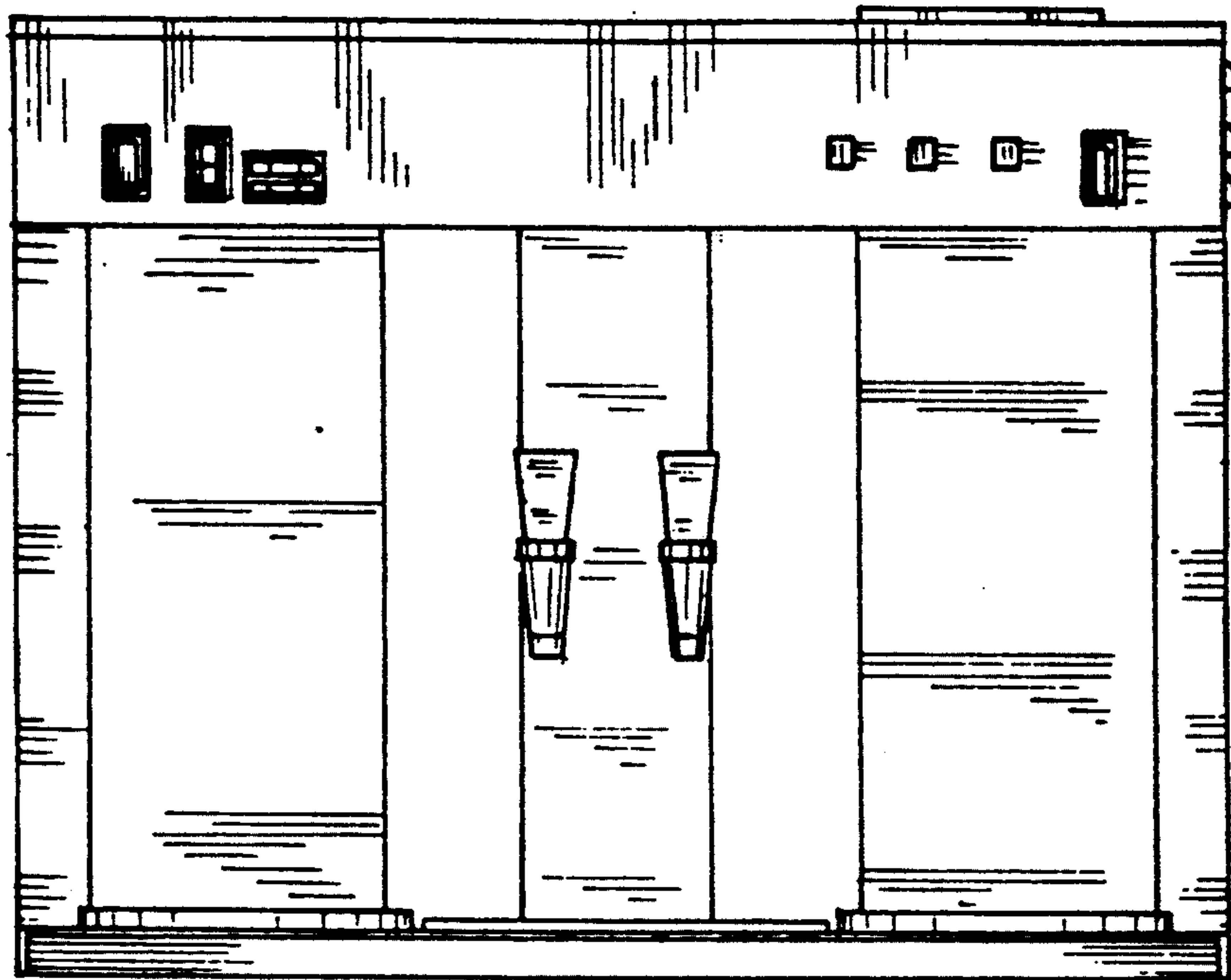

FIG. 3.

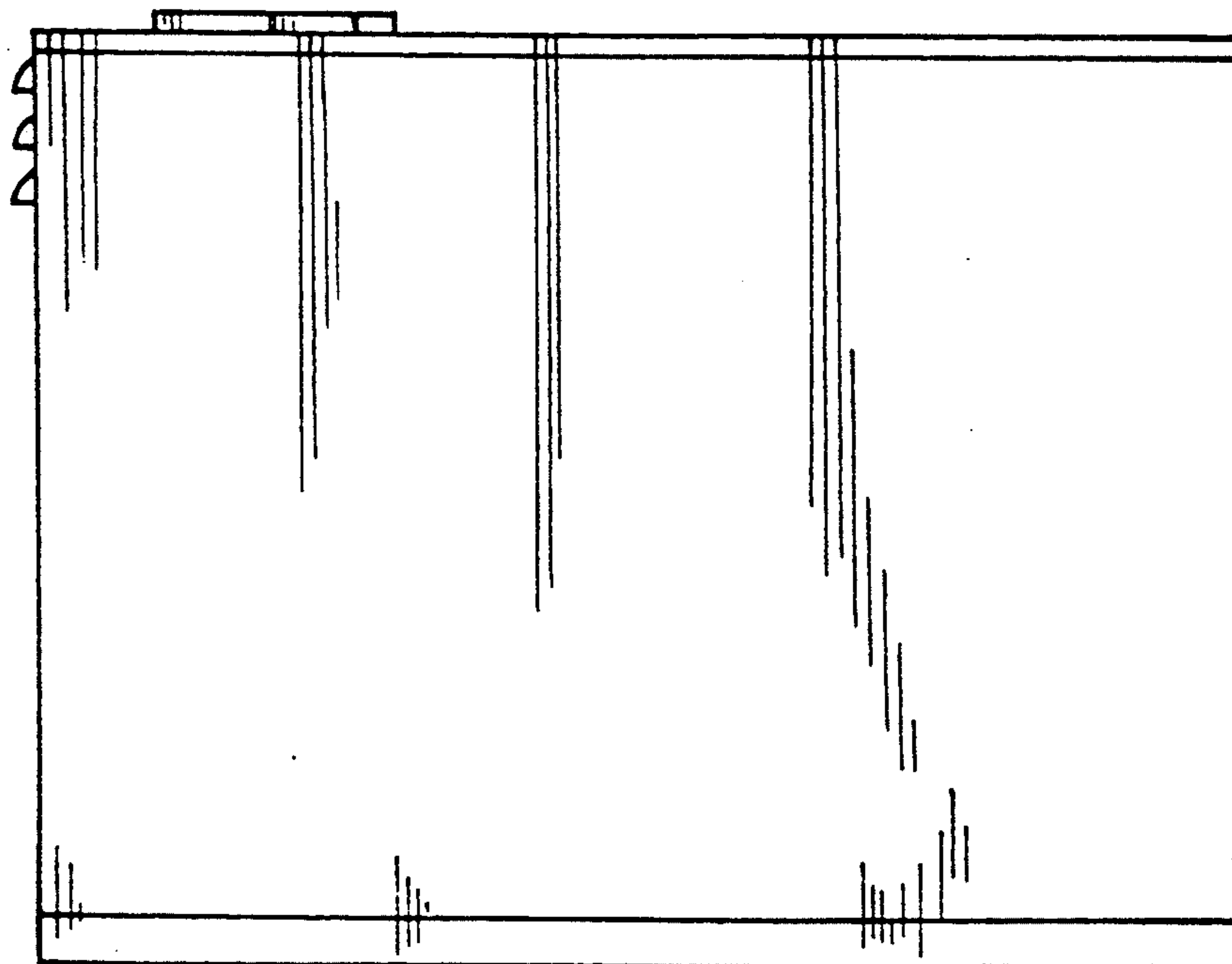

FIG. 4.



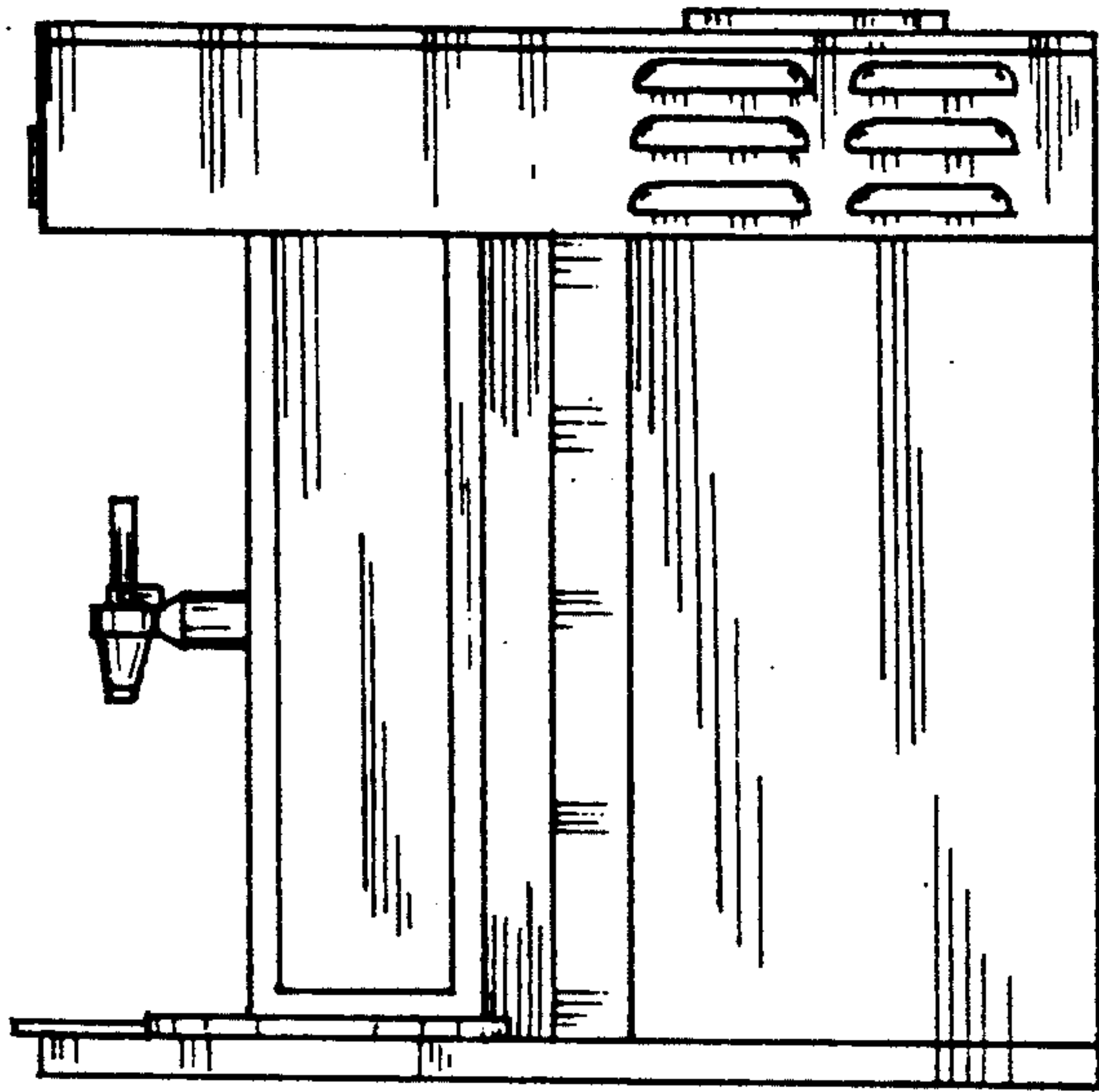

FIG. 5.

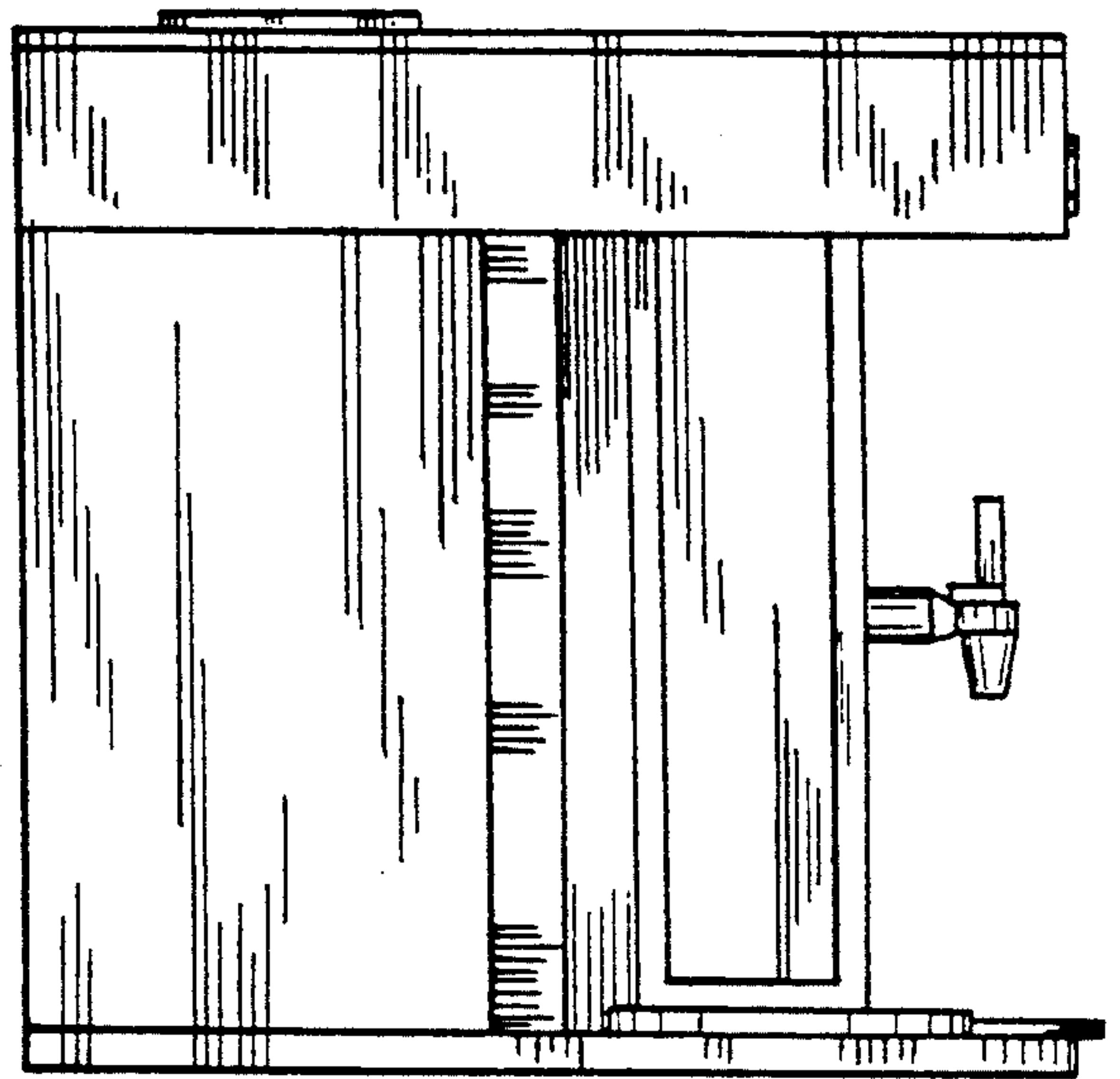

FIG. 6.

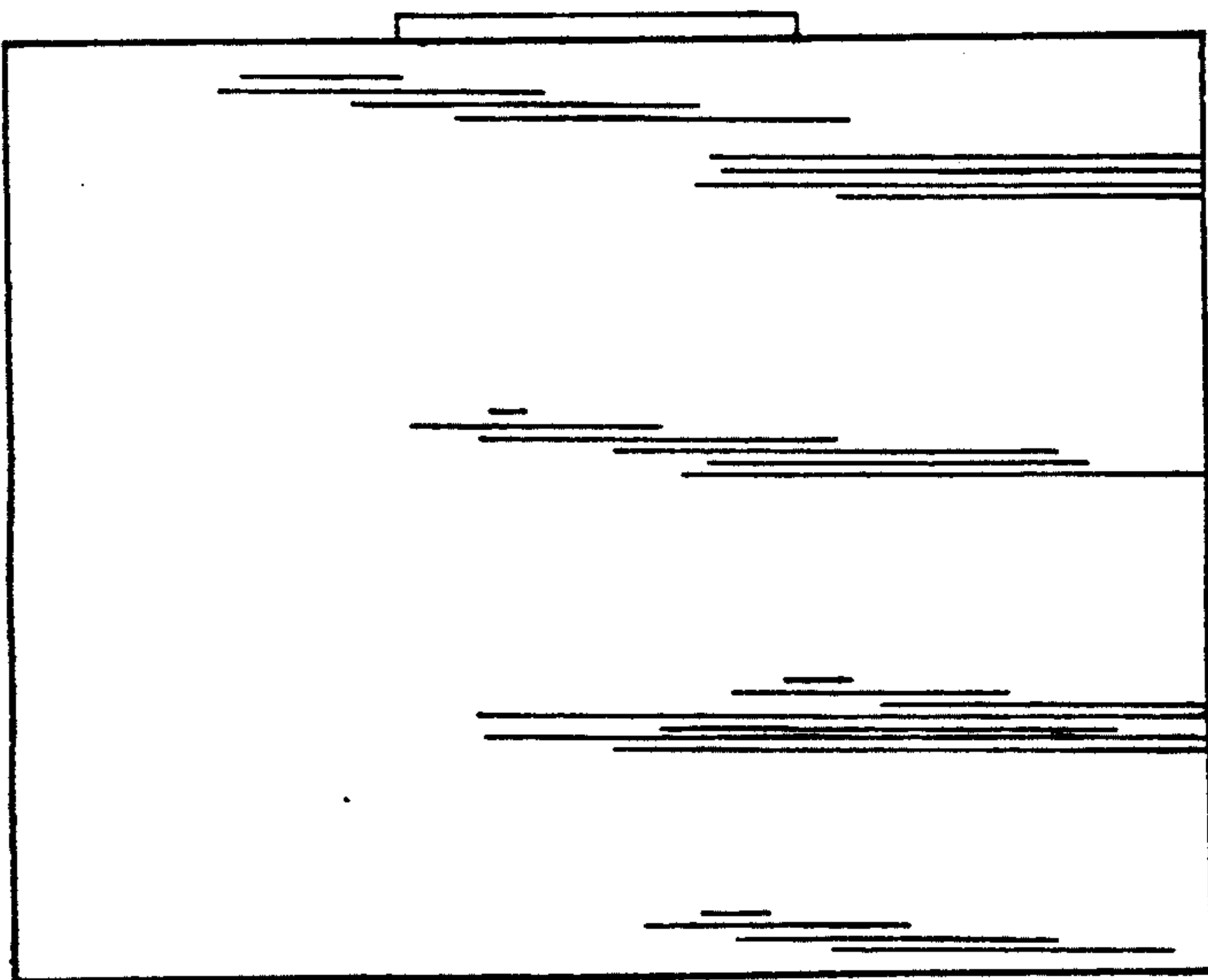

FIG. 7.